

LP PHOT 02



Our instruments' quality level is the results of the product continuous development. This can bring about differences between the information written in this manual and the instrument that you have purchased. We cannot entirely exclude errors in the manual, for which we apologize.
The data, figures and descriptions contained in this manual cannot be legally asserted. We reserve the right to make changes and corrections without prior notice.

LP PHOT 02

1 Introduction

LP PHOT 02 probe measures illuminance (lux), defined as the ratio between the luminous flux (lumen) passing through a surface and the surface area (m^2).

The spectral response curve of a photometric probe is similar to the human eye curve, known as *standard photopic curve* $V(\lambda)$. The difference in spectral response between LP PHOT 01 and the standard photopic curve $V(\lambda)$ is calculated by means of the error f_i' .

LP PHOT 02 has been designed for long-time outdoor measurements. The luxmeter designed for outdoor readings, is basically used for taking weather and climate measurements during daylight .

The luxmeter is produced in three versions:

LP PHOT 02	PASSIVE*
LP PHOT 02 AC	ACTIVE , 4..20mA CURRENT output
LP PHOT 02 AV	ACTIVE , 0..1 or 0..5 or 0..10 V VOLTAGE output, to be defined at the order.

* Using SICRAM Module VP 472 it is possible to connect passive pyranometer to Indicator D09847.

2 Working principle

LP PHOT 02 luxmeter is based on a solid state sensor, whose spectral response has been adapted to the desired one, by means of special filters. The relative spectral response curve is shown in fig.1.

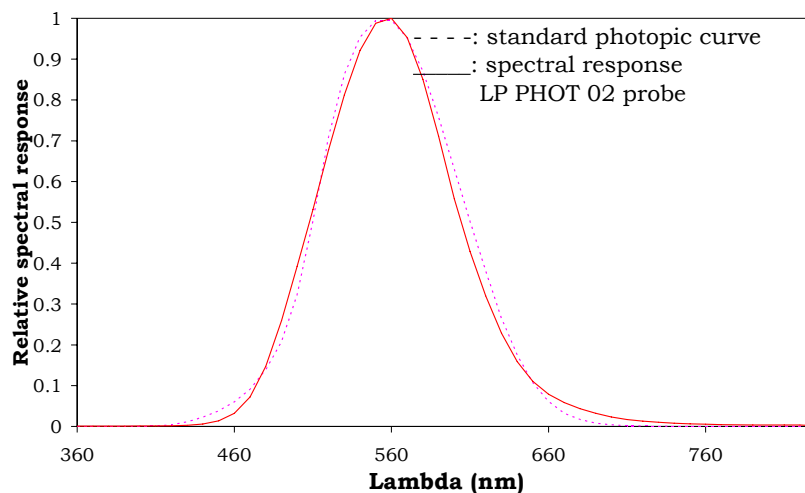

Fig1

LP PHOT 02 is provided with a 50 mm diameter transparent glass dome, in order to protect the sensor against atmospheric damage.

The cosine corrected response has been obtained through both the PTFE diffuser and case particular shapes. Deviation between the theoretical response and the real one, is shown in fig.2.

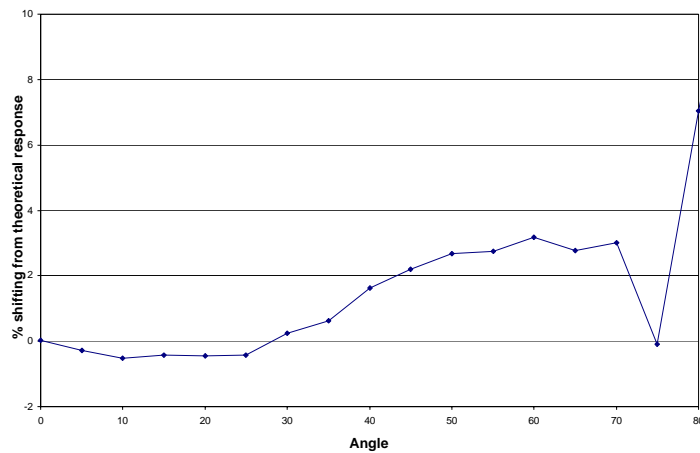

Fig.2

The LP PHOT 02 cosine response allows for use even when the sun elevation is low.

3 Installing and mounting the luxmeter for global radiation measurements:

Before installing the luxmeter, the silica-gel cartridge must be refilled. Silica-gel crystals absorb humidity in the dome chamber and in case of particular climatic conditions, prevent internal condensation forming on the dome inner wall, with a consequent alteration in measurements.

Do not wet or touch the instrument with your hands while refilling the silica-gel cartridge. Carry out the following instructions in a dry environment:

- 1- Loosen the three screws that fix the white shade disk
- 2- Unscrew the silica-gel cartridge using a coin
- 3- Remove the cartridge perforated cap
- 4- Open the silica-gel sachet (supplied with the luxmeter)
- 5- Fill the cartridge with silica-gel crystals
- 6- Close the cartridge with its own cap, and check that the sealing O-Ring is in the right position.
- 7- Screw the cartridge to the luxmeter using a coin
- 8- Make sure the cartridge is tightly screwed (otherwise silica-gel crystal will last for a shorter time)
- 9- Position the shade and tighten it with the screws
- 10- The luxmeter is ready for use

Fig.3 shows the operations needed to refill the cartridge with silica-gel crystals

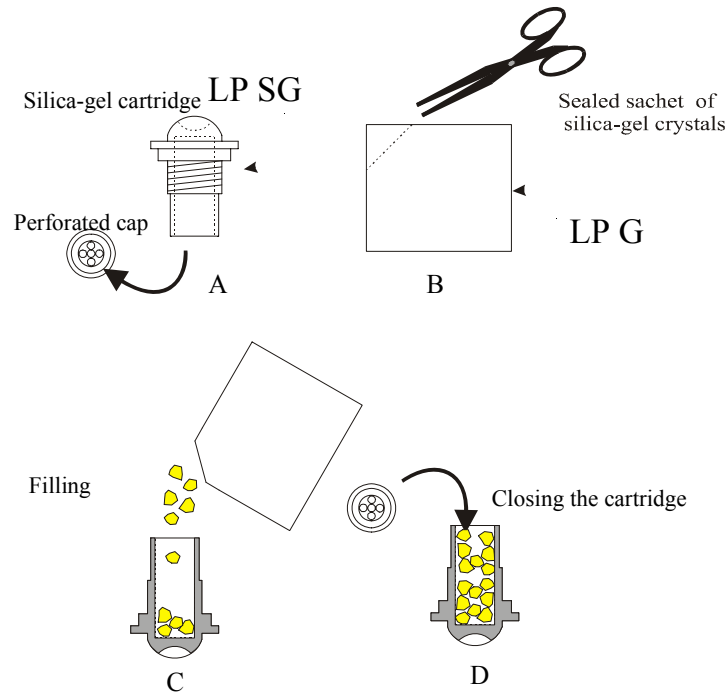

Fig. 3

- To allow cleaning the outer dome regularly and carrying out the instrument maintenance, LP PHOT 02 should be mounted in easily reachable places. At the same time, you should check that no building, tree, or any other obstacle exceeds the horizontal plane where the luxmeter is mounted. In case this is not possible, you should find a place where obstacles do not exceed 5 degrees elevation over the path followed by the sun from rising until sunset.
- The luxmeter should be located far from any obstacle which might reflect sunlight (or any shadow) onto the instrument.
- For a correct horizontal placing, LP PHOT 02 is provided with a bubble level; inclination adjustment of the luxmeter is made by means of two leveling screws. Use the two 6mm-diameter screw holes with an interaxial distance of 65 mm, to mount the instrument on a plane. To access the holes, remove the shade disk and reposition it after mounting (see fig. 4).
- LP S1 mounting kit (fig. 5) is supplied upon demand as an accessory, and allows for an easy mounting of the instrument on a mast. The mast maximum diameter shall not exceed 50 mm. The operator will check that the mast height does not exceed the luxmeter plane, in order to avoid measurement errors due to any reflection or shadow of the mast itself. To fix the luxmeter to the mounting bracket, remove the shade disk by loosening the three screws, then fix the luxmeter to the bracket and mount the white shade disk again.
- The luxmeter should be thermally isolated from the mounting bracket, and the electrical contact with the ground must be properly made.

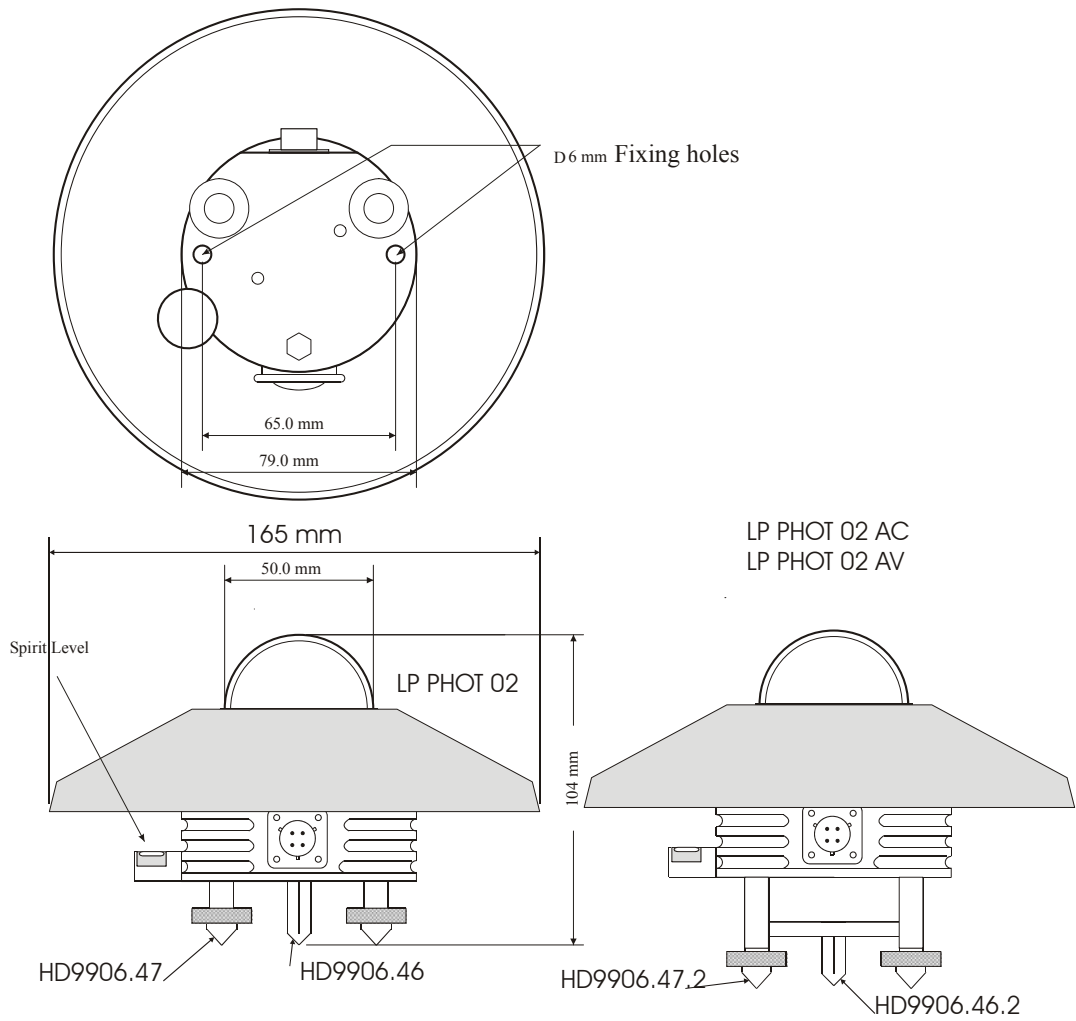

Fig 4

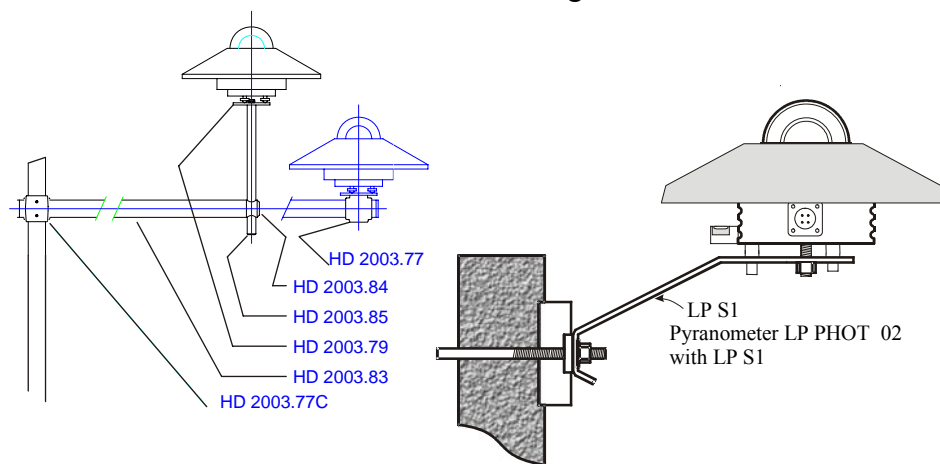

Fig. 5

4 Electrical Connections and requirements for electronic readout devices

LP PHOT 02 is produced in 3 versions, LP PHOT 02, LP PHOT 02 AC and LP PHOT 02 AV.

- LP PHOT 02 luxmeter is passive and it does not require any power supply.
- LP PHOT 02 AC, AV are active and need power supply.

Required voltage is as follows:

8-30 Vcc for LP PHOT 02 AC and LP PHOT 02 AV with 0..1V and 0..5V output supply.

14-30 Vcc for LP PHOT 03 AV with 0..10 V output.

- All version are supplied with a 4 pole connector.
- The optional cable is terminated with a connector at one end and it is made of PTFE UV-proof. It is provided with 3 wires and a braided wire (shield). Cable colors and connector poles are matched as follow (figure 6):

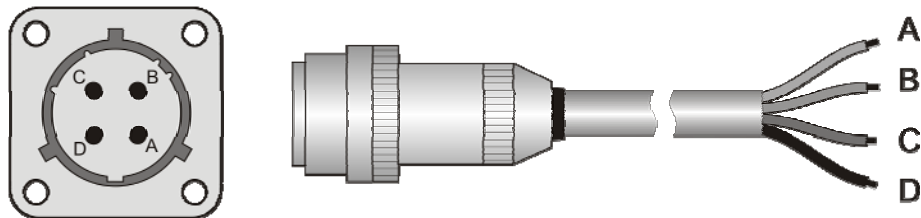

Fig.6

LP PHOT 02

Connector	Function	Color
A	Shield ($\frac{1}{\text{---}}$)	Black
B	Vout (+)	Red
C	Vout (-)	Blue
D	Housing ($\frac{1}{\text{---}}$)	White

LP PHOT 02 AC

Connector	Function	Color
A	Shield ($\frac{1}{\text{---}}$)	Black
B	Positive (+)	Red
C	Negative (-)	Blue
D	Housing ($\frac{1}{\text{---}}$)	White

LP PHOT 02 AV

Connector	Function	Color
A	Shield ($\frac{1}{\text{---}}$)	Black
B	(+) Vout	Red
C	(-) Vout e (-) Vcc	Blue
D	(+) Vcc	White

- The LP PHOT 02 luxmeter has to be connected either to a millivoltmeter or to a data acquisition system with input resistance $> 5M\Omega$. Typically, the radiometer output signal does not exceed 150 mV. In order to better exploit the radiometer features, the readout instrument should have a $1\mu V$ resolution.

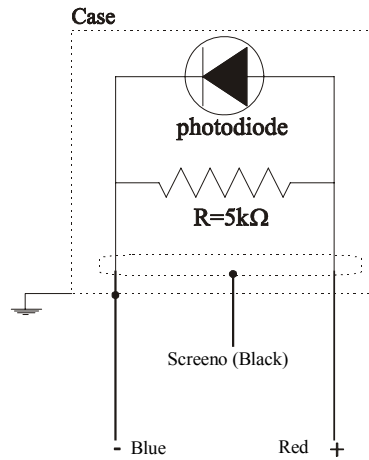

fig. 7

- LP PHOT 02 AC is to be connected to a DMM and a power supply as show below (Figure 8). To read the signal, the load resistance must be $\leq 500\Omega$

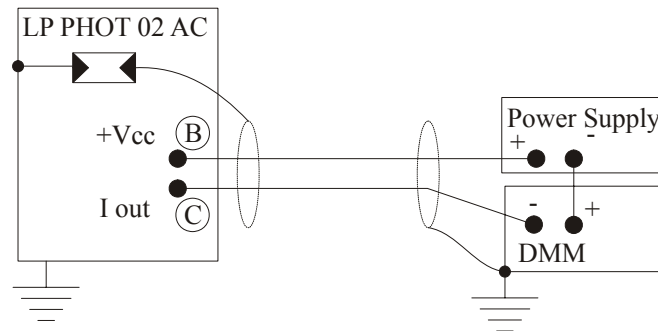

Fig. 8

- LP PHOT 02 AV is to be connected to a DMM and a power supply as show below (Figure 9). To read the signal, the load resistance must be $\geq 100k\Omega$

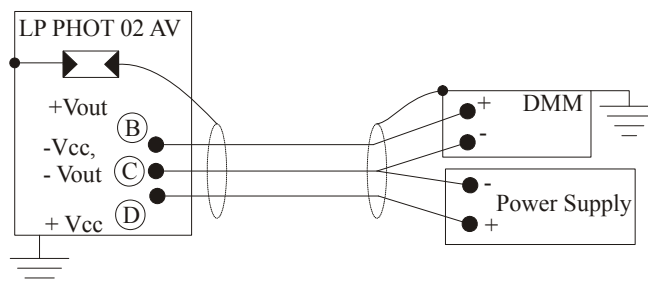

Fig. 9

5 Maintenance:

In order to grant the best precision and accuracy in measurements, the outer dome must be always kept clean; the cleaner you keep the dome, the better the accuracy in measurements will be. Washing can be made with water and standard lens paper; in case this wouldn't work, use pure ETHIL alcohol. After using alcohol, the dome must be washed with water only. Sudden rise and fall in temperature throughout day and night, might cause condensation to appear on the luxmeter dome; in this case the performed reading is highly overestimated. To reduce condensation, the luxmeter is provided with a cartridge containing desiccant material, such as Silica-gel. Silica-gel efficiency decreases in time while absorbing humidity. Active silica-gel crystals are **yellow** colored, while they turn into **blue** when they gradually loose power. To replace them, see instructions at paragraph n. **3**. Silica-gel generally lasts from 2 to 6 months, depending on which climatic conditions you have and where the luxmeter works.

6 Calibration and measurements:

LP PHOT 02

Luxmeter sensitivity, indicated as **S** (or calibration factor), allows determining illuminance by measuring a signal in Volts at the probe ends. **S** factor is measured in V/klux.

- Once the difference of potential (DDP) has been measured at sensor ends, E_e illuminance is obtained through the following formula:

$$E_e = \text{DDP}/S$$

where;

E_e : indicates Illuminance expressed in klux,

DDP: indicates the difference of potential expressed in mV and measured by the multimeter,

S: indicates the calibration factor expressed in mV/klux and shown on the luxmeter label (calibration factor is also mentioned in the calibration report).

LP PHOT 02 AC

The luxmeter sensitivity is set so that:

$$4.20 \text{ mA} = 0.150 \text{ klux}$$

To obtain illuminance the following procedure is to be applied:

-once you know the current (I_{out}) absorbed by the instrument and measured with the DMM, following formula must be applied:

$$E_e = 9.375 \cdot (I_{out} - 4 \text{ mA})$$

where;

E_e : illuminance in klux,

I_{out} : current in mA absorbed by the luxmeter

LP PHOT 02 AV

The pyranometer sensitivity is set so that according to the version:

0..1 V = 0..150 klux

0..5 V = 0..150 klux

0..10 V = 0..150 klux

To obtain irradiance the following procedure is to be applied:

-once you know the instrument output voltage (V_{out}) measured with the DMM, following formula must be applied:

$$E_e = 150 \cdot V_{out} \quad \text{for the version } 0 \dots 1 \text{ V}$$

$$E_e = 30 \cdot V_{out} \quad \text{for the version } 0 \dots 5 \text{ V}$$

$$E_e = 15 \cdot V_{out} \quad \text{for the version } 0 \dots 10 \text{ V}$$

where;

E_e : illuminance in klux,

V_{out} : Output voltage (in Volt) measured by the voltmeter

Each luxmeter is factory calibrated and has its own calibration factor. Calibration is carried out by using a standard illuminant A, as indicated in CIE publication N° 69 "Methods of characterizing illuminance meters and luminance meters: Performance, characteristics and specifications, 1987". Calibration is carried out by comparison with a reference luxmeter, assigned to Delta Ohm Metrological Laboratory.

To get the best performances from LP PHOT 02, we strongly recommend to check calibration annually.

7 Technical specifications:

Typical sensitivity:	1 mV/(klux) LP PHOT 02 4..20 mA (0-150klux) LP PHOT 02AC 0..1,5,10V (0-150klux) LP PHOT 02AV
Response time:	<0.5 sec (95%)
Impedance:	0.5 ÷ 1 KΩ
Measuring range:	0-150 klux
Viewing angle:	2π sr
Spectral range:	Standard photopic curve
Operating temperature:	-40 °C ÷ 80 °C
Error f_1	<9 %
Cosine response/directional error:	< 8 % (between 0° and 80°)
Long term instability: (1 year)	< ±3 %
Non-linearity:	<1 %
Temperature response	< 0.1%/°C
Dimensions:	fig. 4
Weight:	0.90 Kg

8 Ordering codes

ORDERING CODE	ARTICLE
LP PHOT 02	Luxmeter complete with shade disk, dessicant sachet with silica-gel crystals, 2 silica-gel cartridges, bubble level, 4 pole plug and Calibration Certificate.
LP PHOT 02 AC	Luxmeter complete with shade disk, dessicant sachet with silica-gel crystals, 2 silica-gel cartridges, bubble level, 4 pole plug and Calibration Certificate. 4..20 mA signal Output
LP PHOT 02 AV	Luxmeter complete with shade disk, dessicant sachet with silica-gel crystals, 2 silica-gel cartridges, bubble level, 4 pole plug and Calibration Certificate. 0..1V, 0..5V, 0..10V signal output (to be defined when order)
CP AA 1.5	4 pole plug with UV proof cable, L=5m.
CP AA 1.10	4 pole plug with UV proof cable, L=10m.
HD 2003.85	Fixing kit to mount height pyranometer on ϕ 40mm mast (HD2003.84 + HD2003.85+HD2003.79)
HD 2003.79	Fixing kit to mount pyranometers on clamping ϕ 40mm (HD2003.77+HD2003.79)
HD 2003.77	Clamping for mast ϕ 40mm
LP SP1	UV resistant plastic shade disk (BASF LURAN S777K)
LP S1	Mounting kit for LP UVA 02: bracket for attachment to a mast, including fasteners and leveling screws.
LP SG	Desiccant sachet with silica gel crystals, complete with inner O-ring and cap.
LP G	Pack of 5 cartridges of silica gel crystals

GARANZIA



GUARANTEE

GARANTIE

GARANTIA

GUARANTEE CONDITIONS

All DELTA OHM instruments have been subjected to strict tests and are guaranteed for 24 months from date of purchase. DELTA OHM will repair or replace free of charge any parts which it considers to be inefficient within the guarantee period. Complete replacement is excluded and no request of damages are recognized. The guarantee does not include accidental breakages due to transport, neglect, incorrect use, incorrect connection to voltage different from the contemplated for the instrument. Furthermore the guarantee is not valid if the instrument has been repaired or tampered by unauthorized third parties. The instrument has to be sent to the retailer without transport charge. For all disputes the competent court is the Court of Padua.

This guarantee must be sent together with the instrument to our service centre.
N.B.: Guarantee is valid only if coupon has been correctly filled in all details.

Instrument type LP PHOT 02

Serial number _____

RENEWALS

Date _____

Date _____

Inspector _____

Inspector _____

Date _____

Date _____

Inspector _____

Inspector _____

Date _____

Date _____

Inspector _____

Inspector _____

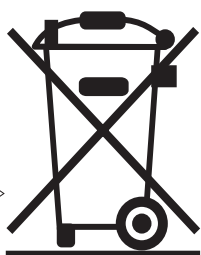

CE CONFORMITY	
Safety	EN61000-4-2, EN61010-1 LEVEL 3
Electrostatic discharge	EN61000-4-2 LEVEL 3
Electric fast transients	EN61000-4-4 LEVEL 3
Voltage variations	EN61000-4-11
Electromagnetic interference susceptibility	IEC1000-4-3
Electromagnetic interference emission	EN55020 class B