

HD35... series

Wireless Data Logging System

ENGLISH

The quality level of our instruments is the result of the constant development of the product. This may produce some differences between the information written in this manual and the instrument you have purchased. We cannot completely exclude the possibility of errors in the manual, for which we apologize.

The data, images and descriptions included in this manual cannot be legally asserted. We reserve the right to make changes and corrections with no prior notice.

TABLE OF CONTENTS

1	INTRODUCTION	4
2	SYSTEM COMPONENTS	6
3	INSTALLING THE SYSTEM	7
4	NETWORK MODIFICATION	13
5	INSTALLING THE HOUSING FOR INDOOR USE	14
6	BASE UNIT HD35AP	15
6.1	AVAILABLE VERSIONS.....	15
6.2	DESCRIPTION	16
6.3	RF LEDs SIGNALS	18
6.4	USB CONNECTION	18
6.5	ETHERNET OR WI-FI CONNECTION.....	18
6.6	RS485 CONNECTION	20
6.7	HD35APR CONNECTIONS	21
6.8	GSM CONNECTION	22
6.8.1	SENDING COMMANDS TO THE BASE UNIT FROM A MOBILE PHONE	22
6.8.2	GPRS TCP/IP CONNECTION	25
6.9	TECHNICAL FEATURES OF BASE UNITS HD35AP – HD35APG – HD35APS – HD35APW	27
6.10	TECHNICAL FEATURES OF BASE UNIT HD35APD	28
6.11	TECHNICAL FEATURES OF BASE UNIT HD35APR.....	28
7	HD35RE... REPEATERS	29
7.1	AVAILABLE VERSIONS.....	29
7.2	DESCRIPTION OF HD35RE IN HOUSING FOR INDOOR USE	29
7.3	DESCRIPTION OF HD35REW IN WATERPROOF HOUSING.....	30
7.4	CONNECTION TO THE WIRELESS NETWORK	30
7.5	ARRANGEMENT OF THE REPEATERS.....	31
7.6	TECHNICAL FEATURES OF THE REPEATER HD35RE.....	32
7.7	TECHNICAL FEATURES OF THE REPEATER HD35REW	33
8	HD35ED... DATA LOGGERS FOR INDOOR USE	34
8.1	DESCRIPTION	34
8.2	CONNECTION TO WIRELESS NETWORK.....	40
8.3	DATA LOGGERS WITH LCD OPTION	40
8.3.1	MAXIMUM, MINIMUM AND AVERAGE OF THE MEASUREMENTS	42
8.4	THE MENU IN LCD DATA LOGGERS	42
8.4.1	THE MENU IN DATA LOGGERS WITH GRAPHIC LCD.....	42
8.4.2	THE MENU IN DATA LOGGERS WITH CUSTOM LCD	47
8.5	CONNECTING THE MODEL WITH TERMINAL HEADER INPUTS	51
8.5.1	INPUTS CONFIGURATION	51

8.6	CALIBRATION	53
8.6.1	CO SENSOR CALIBRATION	53
8.6.2	REPLACING THE CO SENSOR.....	54
8.6.3	CO ₂ SENSOR CALIBRATION.....	55
8.6.4	CO ₂ SENSOR AUTOCALIBRATION	56
8.6.5	CALIBRATING THE RELATIVE HUMIDITY SENSOR	57
8.6.6	DIFFERENTIAL PRESSURE CALIBRATION	58
8.6.7	SENSITIVITY OF THE ILLUMINANCE AND/OR UVA IRRADIANCE PROBE.....	58
8.7	TECHNICAL CHARACTERISTICS OF DATA LOGGERS IN INDOOR USE HOUSING	59
9	HD35EDW... WATERPROOF DATA LOGGERS	66
9.1	DESCRIPTION	66
9.2	INSTALLATION OF WATERPROOF HOUSING	72
9.3	CONNECTION TO THE WIRELESS NETWORK	72
9.4	DATA LOGGER WITH LCD OPTION	73
9.5	CONNECTING THE MODEL HD35EDWH WITH TERMINAL HEADER INPUTS.....	74
9.6	CONNECTING THE MODEL HD35EDW-MB WITH RS485 MODBUS-RTU INPUT	76
9.7	ADAPTER FOR CO ₂ CALIBRATION WITH THE NITROGEN CYLINDER	77
9.8	RAIN GAUGE CONNECTION	77
9.9	TECHNICAL CHARACTERISTICS OF DATA LOGGERS IN WATERPROOF HOUSING	78
10	HD35EDLM... DATA LOGGERS FOR WEATHER STATIONS.....	84
10.1	DESCRIPTION	84
10.2	MEASURING PROBES	85
10.3	INSTALLATION OF HOUSING.....	86
10.4	CONNECTION TO THE WIRELESS NETWORK	86
10.5	DISPLAY	87
10.6	TECHNICAL CHARACTERISTICS OF DATA LOGGERS FOR WEATHER STATIONS	88
11	HD35ED-ALM REMOTE ALARM DEVICE.....	91
11.1	DESCRIPTION	91
11.2	CONNECTION	91
11.3	CONNECTION TO THE WIRELESS NETWORK	92
11.4	TECHNICAL CHARACTERISTICS OF THE ALARM DEVICE	92
12	MODBUS	93
13	DIMENSIONS.....	107
14	RELATIVE HUMIDITY AND TEMPERATURE PROBES.....	111
15	STORAGE OF INSTRUMENTS	116
16	SAFETY INSTRUCTIONS.....	116
17	ORDERING CODES	117

1 INTRODUCTION

The Delta OHM wireless data logging system allows several physical quantities to be monitored in a large variety of application fields. Data loggers are available for the monitoring of:

- Temperature
- Humidity
- Atmospheric pressure
- Differential pressure
- Luminance (lux)
- UVA, UVB and UVC irradiance
- Carbon monoxide (CO)
- Carbon dioxide (CO₂)
- Solar radiation
- Rainfall quantity
- Wind speed and direction
- Leaf wetness
- WBGT index
- Acceleration

The models that measure relative humidity and temperature calculate humidity derived quantities. Calculated quantities depend on the model and can be: dew point temperature, wet bulb temperature, absolute humidity, mixing ratio, partial vapor pressure.

Data loggers provided with built-in sensors and data loggers with external probes are available. They can be connected through M12 connectors or terminals according to the model. The data loggers with terminal header input can be connected to:

- Transmitters with 0÷20 or 4÷20 mA current output and 0÷50 mV, 0÷1 V or 0÷10 V voltage output (*Note: 0÷10 V only for HD35EDWH*)
- Pt100 / Pt1000 temperature sensors and K, J, T, N, E thermocouples
- Voltage-free contact output (commutations counting) or potentiometric sensors

This allows the monitoring capability of the system to be extended to many other quantities in addition to the ones mentioned above.

For each detected quantity, the user can set two alarm thresholds (high threshold and low threshold). The overrun of the thresholds can be indicated by an audible signal of the data logger through an internal buzzer; the alarm signal is immediately transmitted to the base unit and displayed on the PC. A wireless remote alarm module with relay output is available allowing other signaling devices (sirens, flashing lights...) or actuators to be activated. If the system is equipped with a GMS module, the alarm can be signaled also by e-mails or SMS messages.

Systems with the following transmission frequencies are available: **868 MHz** (in compliance with EN 300 220 European Directive), **902-928 MHz** (in compliance with U.S. FCC part 15 section 247 and I.C. RSS-210 Directives) and **915,9-929,7 MHz** (in compliance with ARIB STD-T108 standard).

Thanks to wireless transmission, the installation of the system is a very simple and quick operation. In addition, the user will not have to remove the data logger from its position or reach the place where the data logger is installed to download the data measured with the PC.

The correctness of the transmitted data is ensured by the **bidirectional** communication between the base unit and the remote data loggers.

HD35AP-S basic PC software supplied with the product allows configuration of all system devices, display of connection status, level of the RF signal and battery charge level, data automatic download at regular intervals or manual download on request of the user. The data transferred to the PC are entered into a database. If the PC is connected to a local network, in-

stalling the **optional HD35AP-PLUS or HD35AP-CFR21** advanced version of the software allows also other computers connected to the same local network to access the data stored into the database.

Data loggers comply with **EN 12830** standard. The **optional HD35AP-CFR21** advanced version of the software is designed in compliance with **FDA 21 CFR part 11** recommendations: the operations are protected by access codes and a record of the performed operations is kept.

2 SYSTEM COMPONENTS

The system consists of the following components:

- **HD35AP...** base unit
- **HD35RE...** repeaters
- **HD35ED...** series of data loggers
- **HD35ED-ALM** remote alarm device

HD35AP... BASE UNIT

This device acts as an interface between the network data loggers that are positioned in the measurement sites, and the PC. It communicates wireless with the remote data loggers.

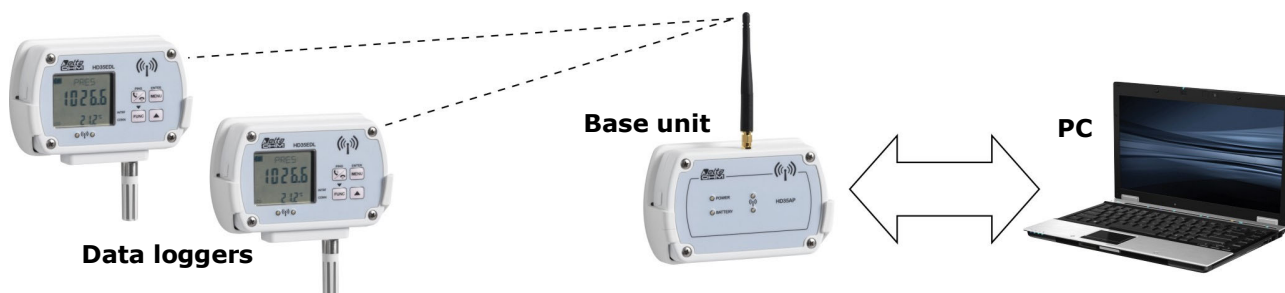

Fig. 2.1: base unit placed between data loggers and PC

HD35RE... REPEATERS

These devices are able to act as a bridge between the base unit HD35AP... and the remote data loggers HD35ED..., allowing the communication distance between data loggers and base unit to be increased. Several repeaters in cascade can be used.

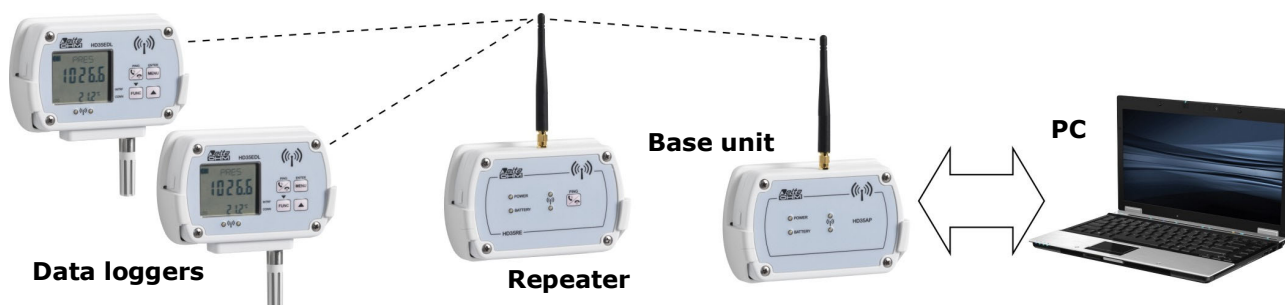

Fig. 2.2: repeater placed between data loggers and base unit

HD35ED... DATA LOGGERS

Remote devices with measurement probes. They are installed in the locations to be monitored. They acquire measurements, store them in the internal memory and send them automatically to the base unit at regular intervals or on request of the user. Versions with or without LCD display are available.

HD35ED-ALM REMOTE ALARM DEVICE

Device equipped with relay outputs that allows to activate, in case of an alarm, signaling devices (sirens, flashing lights...) or actuators.

3 INSTALLING THE SYSTEM

Before placing the devices in the final working environment, it is recommended to perform the system function test on the bench. The bench test allows also the wireless network to be configured more easily, in case the supplied system is not factory-configured.

To check and make the system operational, proceed as follows:

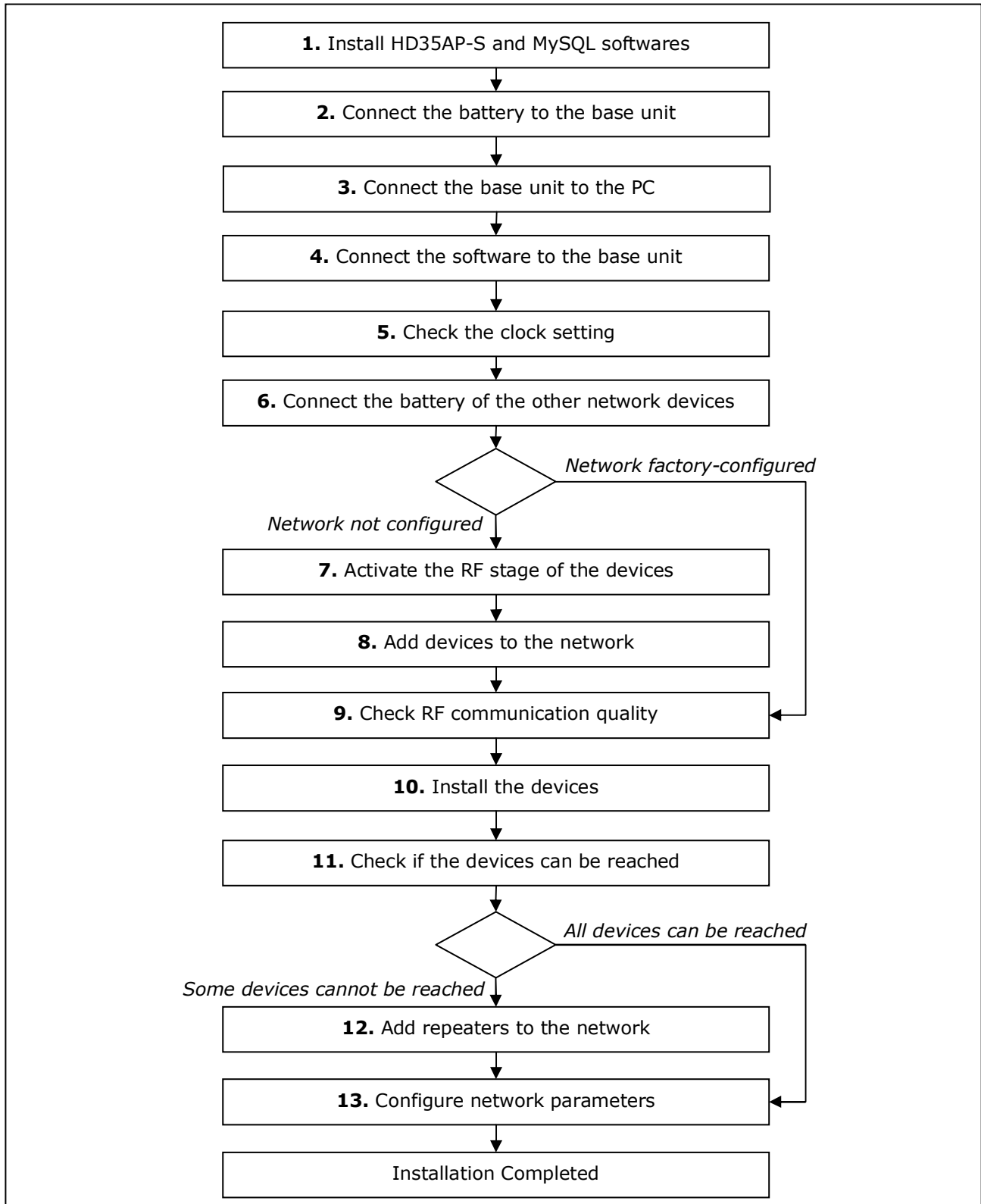

Fig. 3.1: system installation procedure

1. INSTALLING HD35AP-S SOFTWARE

The base unit is supplied with a CD-ROM containing the HD35AP-S software and MySQL Data Base Management System. Install both HD35AP-S and MySQL in your PC. Concerning the installation of MySQL, **thoroughly** follow the installation guide contained in the CD-ROM.

2. CONNECTING THE BASE UNIT BATTERY (not for HD35APD and HD35APR)

For shipments by aircraft, the battery of the devices must be disconnected.

1. Unscrew the 4 front screws of the housing and remove the back cover.
2. Attach the battery connector to the electronic board, paying attention to the correct polarity. The connector is equipped with a polarization key that prevents the possibility of a wrong insertion of the connector.

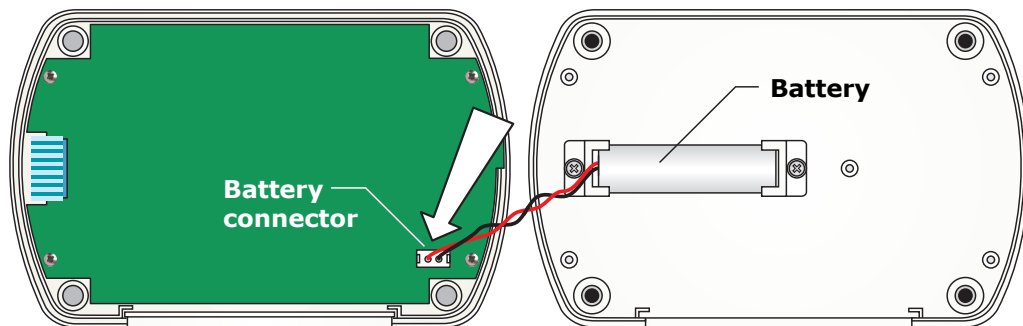

Fig. 3.2: battery in the devices in housing for internal use

3. Close the housing by fixing the 4 front screws.

- **Factory-configured system: first connect the battery of the base unit** and check the clock setting. Only after this operation, connect the battery of the data loggers, so that the clock can be synchronized with the updated clock of the base unit at startup.
- **Not configured system:** at startup, data loggers don't synchronize the clock with that of the base unit, consequently it is not important to power the base unit as first.

3. CONNECTING HD35AP... BASE UNIT TO YOUR PC

The HD35AP... base unit can be connected to the USB port of a PC through the **CP23** cable (directly with USB A-type connector for HD35APD...). In this connection mode, the base unit is powered through the USB port of the PC.

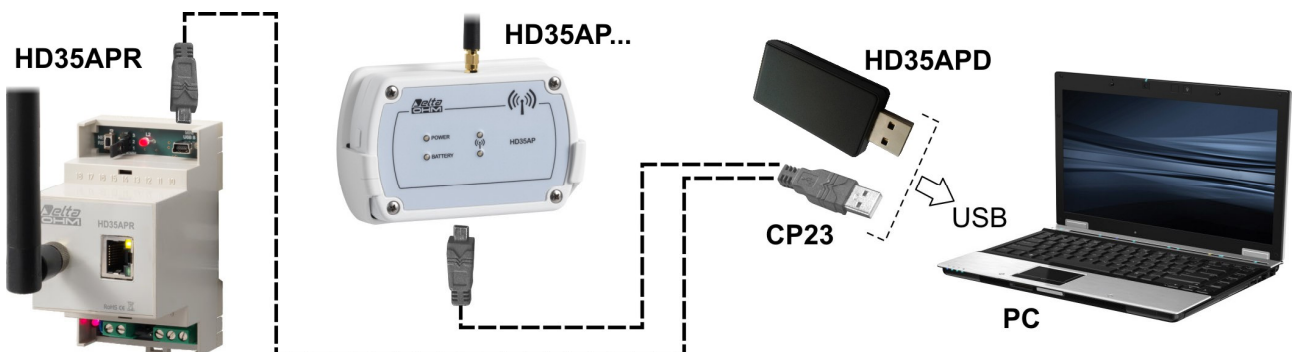

Fig. 3.3: connecting the base unit to your PC

The USB connection doesn't require the installation of drivers: when the base unit is connected to the PC, Windows® operating system automatically recognizes the unit as an HID (Human Interface Device) device and uses the drivers already included in the operating system.

Note: even the base units HD35APW and HD35APR, with Wi-Fi and/or Ethernet interface, must first be connected to the PC via USB through the CP23 cable for setting the parameters of the local network (e.g., for setting the IP address, for choosing the Wi-Fi or Ethernet mode, etc.).

4. CONNECT THE SOFTWARE TO THE BASE UNIT

Start the HD35AP-S software in your PC and perform the connection procedure illustrated in the chapter " *Connection to base unit* " of the software online help (software instructions are also available in PDF format in the CD-ROM).

5. CHECK THE CLOCK SETTING

Select the item " *Setting of date and time* " of HD35AP-S software and make sure that the clock of the base unit is updated. If the clock is not updated, set it as explained in the chapter " *Clock setting* " of the software online help.

6. CONNECT THE BATTERY OF THE OTHER NETWORK DEVICES

Connect the battery of the other devices following the procedure indicated at step 2 of the previous page. In the devices with waterproof housing, the position of the battery and the connector is shown in the following figure.

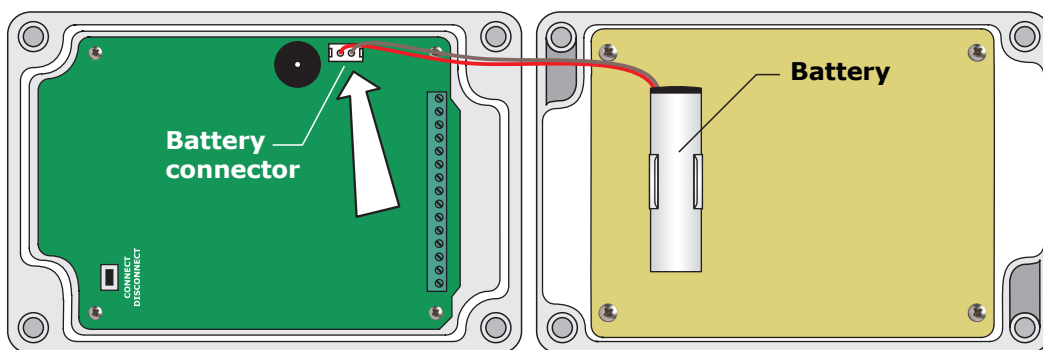

Fig. 3.4: battery in devices with waterproof housing

The models in waterproof housing with CO₂ probe and the model with RS485 Modbus-RTU input have no internal battery: connect the 7...30 Vdc external power supply.

- **Factory-configured system:** at startup, data loggers synchronize the clock with that of the base unit. If the base unit is not yet connected to the power supply, the synchronization fails and data loggers with LCD option display the clock setting window. Clock synchronization will anyway take place automatically after connecting the base unit to the power supply. Meanwhile, data loggers start storing measurements with their date and time, not synchronized with respect to the system measurements. If you wish to set the clock manually, see paragraph *The menu in LCD data loggers* on page 42.
- **Not configured system:** at startup, data loggers don't synchronize the clock with that of the base unit. In the data loggers with LCD, the window for the clock setting is displayed. Clock synchronization will take place automatically after network configuration (step 8), in the meantime data loggers start storing measurements with their date and time. If you wish to set the clock manually, see paragraph *The menu in LCD data loggers* on page 42.

7. ACTIVATING THE RF STAGE IN THE DEVICES (DATA LOGGERS, REPEATERS AND ALARM MODULES)

In the devices belonging to a factory-configured system, the RF stage is activated automatically. In this case, proceed to step 9.

If the system is not factory-configured, the RF stage of the devices will have to be activated manually by pressing the connection button for 5 seconds. In the models in indoor-use housing, the connection button is on the front panel.

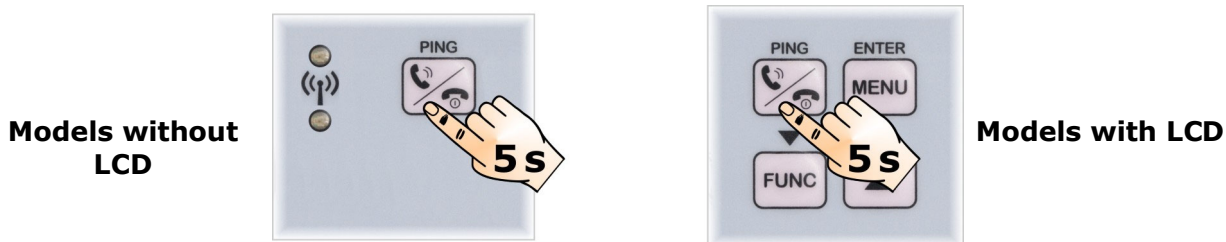

Fig. 3.5: connection button in models in indoor-use housing

In models with waterproof housing, the connection button is inside the instrument (see fig. 9.3.1 on page 72).

The activation of the RF stage is signaled by the lightning-up of the green RF LED for one second and by a beep of the buzzer. Successively, the red RF LED will start blinking until the device is added to a wireless network following the procedure indicated at step 8.

In data loggers with LCD display, the activation of the RF stage is signaled also by the connection icon. The icon will go on blinking until the device is added to a wireless network.

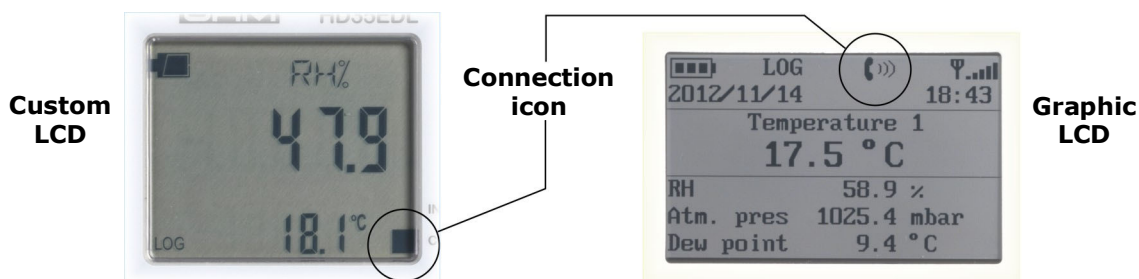

Fig. 3.6: connection icon in the display

In case of doubt of the RF stage status in the devices without LCD (for example, because LEDs seldom blink due to a long logging interval), press the connection button for 5 seconds. If the green RF LED lights up, the RF stage was not active and will be activated. If the red RF LED lights up, the RF stage was already active and will be deactivated; in that case, press again the connection button for 5 seconds to reactivate it.

8. ADDING THE DEVICES TO THE NETWORK

If the network structure is not configured, it is necessary to add data loggers and any repeaters and alarm modules to the base unit. The adding procedure, described in detail in the chapter "Adding devices to the network" in the software online help, is briefly outlined hereunder:

1. Select the command "Network" of HD35AP-S software.
2. In the section "Add Devices" of the window "Network", select the button "Execute search".
3. At the end of the search, the software will list the devices available to be added to the network; select the devices, identified by the RF address, and enter the serial number of each device (RF address and serial number are written on the label on the rear of the instrument).
4. Select the button "Add to network".

Note: the procedure for adding the devices to the network allows a limited number of devices to be added at a time. If the software doesn't list all the devices to be added, complete in any case the procedure with the listed devices and repeat the procedure to add the missing devices. By repeating the procedure, the software will list only the devices that have not been added yet.

The maximum number of devices that can be added to a base unit depends on the data transmission interval, as indicated in the following table.

TAB. 3.1: Number of devices manageable by the base unit

Data transmission interval	Number of devices manageable by the base unit	Data transmission interval	Number of devices manageable by the base unit
1 s	12	10 s	120
2 s	24	15 s	180
5 s	60	> 30 s	254

The table refers to the condition of direct transmission between base unit and data loggers (1 "Hop"). In the presence of repeaters, the data transmission requires more time, and the number of devices manageable by the base unit could be lower than the one indicated.

9. CHECKING THE QUALITY OF RF COMMUNICATION

The correct RF communication between base unit and the other devices connected to the network can be checked in the following ways:

- In the main window of the HD35AP-S software, by checking that the RF signal level remains high, that the strength of the received signal RSSI (Received Signal Strength Indication) exceeds -85 dBm and that the percentage of transmission errors PER (Packet Error Rate) is close to zero.

AP_41 [HD35APS Plus SN:12016692 - AP test]						
	Model	SN	Connection status	Signal level img	Reception power	PER mac
▶	ED_76	HD35EDL1N4r2TV	12039377	CONN	[Signal Level Bar Chart]	-36 (dBm) 00,0 (%)
	ED_107	HD35EDL1NTC	13022851	CONN	[Signal Level Bar Chart]	-61 (dBm) 00,0 (%)
	ED_92	HD35EDL1NTV	11011875	CONN	[Signal Level Bar Chart]	-54 (dBm) 00,0 (%)

Fig. 3.7: verification of RF communication with HD35AP-S software

- In data loggers with display, by checking that the strength of the received signal RSSI exceeds -85 dBm and that the percentage of transmission errors PER is close to zero. Use the button ▲ to display RF RSSI and PER quantities.
- In the devices without display, by briefly pressing the connection button (PING function) and by making sure that the green RF LED blinks for a few seconds;

10. INSTALLING THE DEVICES

After a bench test of the system, proceed with the individual installation of the devices in the final work location.

If data loggers using external probes with cable are installed, place the probes in the environment to be monitored and connect them to the data loggers (for the connectors layout, see chapters *HD35ED... DATA LOGGERS FOR INDOOR USE* on page 34 and *HD35EDW... WATER-PROOF DATA LOGGERS* on page 66).

11. CHECKING WHETHER THE DEVICES ARE REACHABLE

After installing the devices, you need to verify again the correct RF communication between the base unit and the other devices of the network, in order to make sure you didn't place the devices too far from the base unit or in places that make RF transmission difficult (shielded environments or with several obstacles). To check RF communication, proceed as indicated at step 9.

12. ADDING REPEATERS TO THE NETWORK

If a device is not reachable after installation (it fails communication with the base unit), it could be necessary to install one or more repeaters in intermediate points between the device and the base unit.

To add a repeater to the network, connect the internal battery to the repeater and repeat the installation procedure from step 7 only for the repeater.

13. CONFIGURING NETWORK PARAMETERS

Through the HD35AP-S software, set all the system operation parameters: logging intervals, alarm thresholds, user codes, etc.

For data loggers, specify whether they are installed in a stationary location or mobile location (for ex. in an articulated vehicle).

See software instructions for the setting of the various parameters.

CHANGING THE RF BAND IN THE ...U MODELS

The ...U models can operate in the 902-928 (U.S.A. and Canada), 915-928 (Australia) or 921-928 (New Zealand) MHz frequency band. To change the band in the devices with LCD, select the *RF Frequency* item of the *RF Parameters* menu (models with graphic LCD) or the *RF_FREQ_MHZ* item of the *RF_MENU* menu (models with custom LCD). To change the band in the devices without LCD, proceed as follows:

- 1) If the device is equipped with mini-USB connector on the housing side, connect it to the PC by means of the **CP23** cable.
- 2) Start the HD35AP-S software and select the *Tools >> HID terminal* command.
- 3) Select *Setup >> Uart configuration*.
- 4) Set the Baud Rate to 9600 for the ...ED devices. Set the Baud Rate to 115200 for the ...RE and ...AP devices. Press *Apply*.
- 5) Select *Connect*.
- 6) Transmit the command **<000>PW;nnnn** with *nnnn*=administrator password.
- 7) Transmit the command **<000>MC;n** with *n*=1 for the 902-928 MHz band, *n*=2 for the 915-928 MHz band and *n*=3 for the 921-928 MHz band.
- 8) Select *Disconnect*.

Note: after the transmission of a command, check that in the reply of the device appears the confirmation symbol **&**.

4 NETWORK MODIFICATION

One or more devices can be added or removed to/from the network at any time.

ADDING A DEVICE TO AN ALREADY OPERATING NETWORK

To add a device to the network, connect the internal battery to the device and repeat the installation procedure from step 7 concerning only the device to be added.

REMOVING A DEVICE FROM AN ALREADY OPERATING NETWORK

To remove a device from the network, follow the procedure indicated in detail in the chapter "*Removing devices from the network*" of the software online help, and briefly described here-under:

1. Select the command "*Network*" of the HD35AP-S software.
2. In the section "*Delete Devices*" of the window "*Network*", select the device that you wish to remove from the network.
3. Select the button "*Delete Devices*".

The removal procedure of a device from the network allows to select whether to turn-off the device RF circuit after disconnection or to keep it turned-on so as to allow any connection to another network. If the RF circuit is kept turned-on, it turns-off after 30 minutes if in the meantime the device is not connected to another network.

5 INSTALLING THE HOUSING FOR INDOOR USE

The installation of models in indoor-use housing can be fixed, by means of anodized-aluminum flanges to be attached to the back of the housing, or removable, by means of a practical plastic support to be fixed to the wall. The use of flanges allows preventing the instrument to be taken away, thanks to the possibility of applying a padlock, inserted in a fastening pin to be fixed to the wall.

Removable installation

1. Fix the plastic support to a wall.
2. Insert the device into the support pushing it downwards.

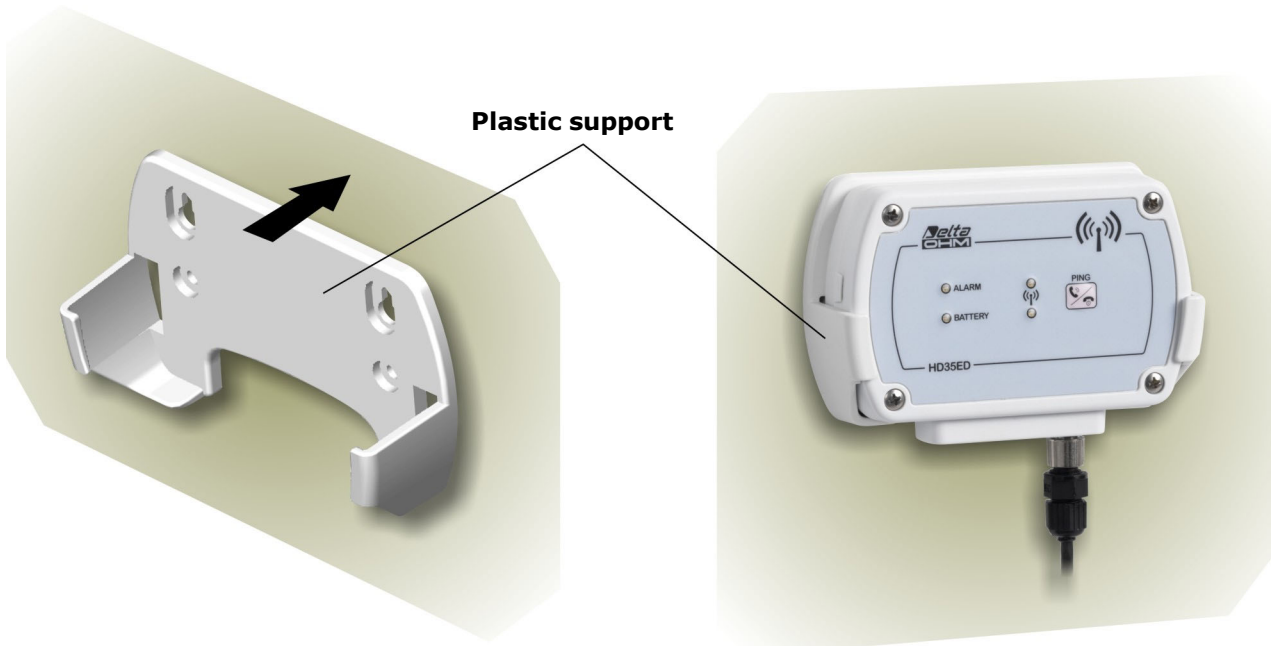

Fig. 5.1: removable installation of the indoor-use housing

Fixed installation

1. Fasten the two flanges to the back of the device housing.
2. Fix the padlock pin and the device with the flanges to the wall.
3. Attach the padlock.

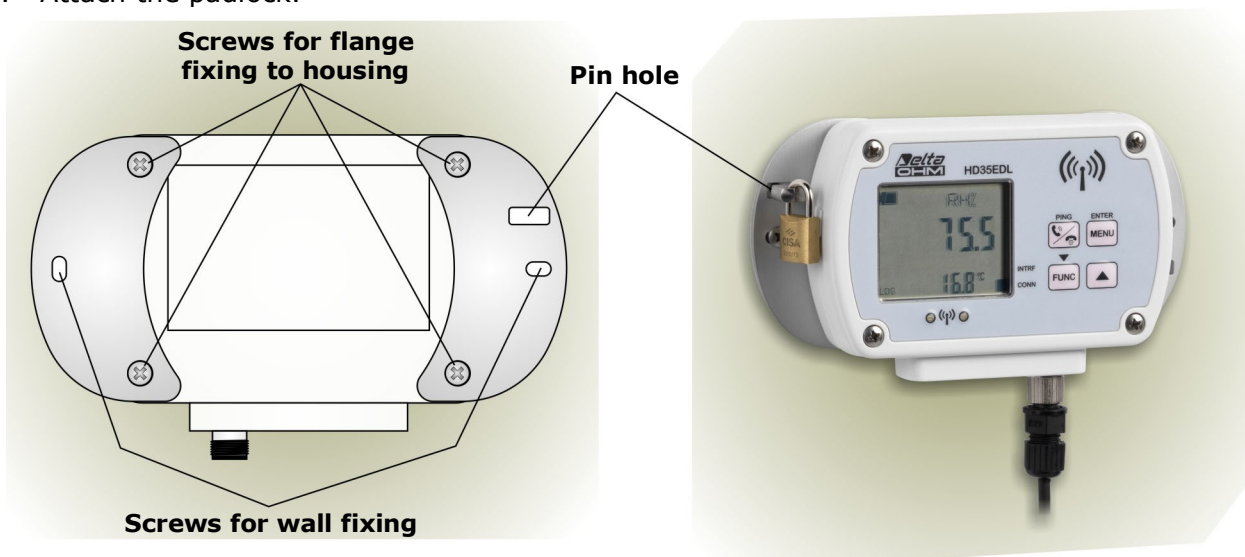

Fig. 5.2: fixed installation of indoor-use housing

6 BASE UNIT HD35AP...

6.1 AVAILABLE VERSIONS

- **HD35AP:** With USB output only.
- **HD35APD:** With the USB output only. "Dongle" version powered only by the PC USB port (without internal battery and without input for the external power supply).
- **HD35APS:** With USB output and **RS485** output with **MODBUS-RTU** protocol. The base unit operates as a multiplexer for the transmission of MODBUS commands from PC/PLC to network devices.
- **HD35APW:** With USB output, **Wi-Fi** interface for connection to the local wireless network and **ETHERNET** connection for cable connection to the local network. Permits (if the Internet connection is available) sending alarm **e-mail** and the recorded data via **e-mail** or to an **FTP** address (*). It allows the use of **MODBUS TCP/IP** protocol. **Multi-client** feature: multiple HD35APW base units can be connected to the same local network. Integrated Web server with monitor function.
- **HD35APR:** Version for 35 mm DIN rail. With USB output, **RS485** output with **MODBUS-RTU** protocol and **ETHERNET** connection for cable connection to the local network. Permits (if the Internet connection is available) sending alarm **e-mail** and the recorded data via **e-mail** or to an **FTP** address (*). It allows the use of **MODBUS TCP/IP** protocol. **Multi-client** feature: multiple HD35APR base units can be connected to the same local network. Integrated Web server with monitor function.
- **HD35APG:** With USB output and integrated **GSM** module for **e-mail** or **SMS** alarm transmission and stored data transmission via **e-mail** or to an **FTP** address (*). It allows communication with a PC through the **GPRS TCP/IP** protocol.

(*) **In the basic version, the data are sent via FTP with an interval of not less than 2 minutes and only if in the network there are up to 5 data loggers. For the full FTP functionality, the PLUS option has to be requested.**

6.2 DESCRIPTION

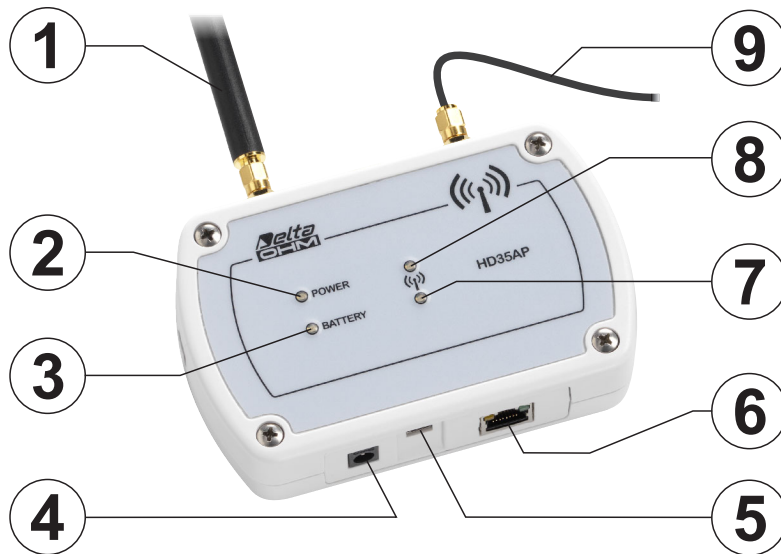

1. RF antenna for transmission in ISM band. In the HD35APG model the antenna is on the left. In the other models the antenna is in the center.
2. POWER LED: in red color, it indicates the presence of an external power supply; it blinks if the battery is recharging.
3. BATTERY LED: in green color, it indicates the internal battery charge level. When the indicator light is steady on, the battery is fully charged; as the battery is running low, the LED blinks with a lower and lower frequency (the blink period increases of 1 second for each 10% decrease of the battery charge).
4. Connector for external 6 Vdc power supply (**SWD06**).
5. Mini-USB connector for PC connection. The PC USB port powers the instrument in the absence of an external power supply.
6. Connector present only in **HD35APW** and **HD35APS** models. In HD35APW models, the connector is a RJ45 type for connection to the ETHERNET network. In HD35APS models, the connector is a 8-pole M12 type for connection to the RS485 network.
7. Green RF LED: it blinks when the unit is in normal operation mode.
8. Red RF LED: it blinks to signal problems in RF transmission.
9. GSM antenna cable (only **HD35APG**). Place the GSM antenna at least 30 cm away from the RF antenna.

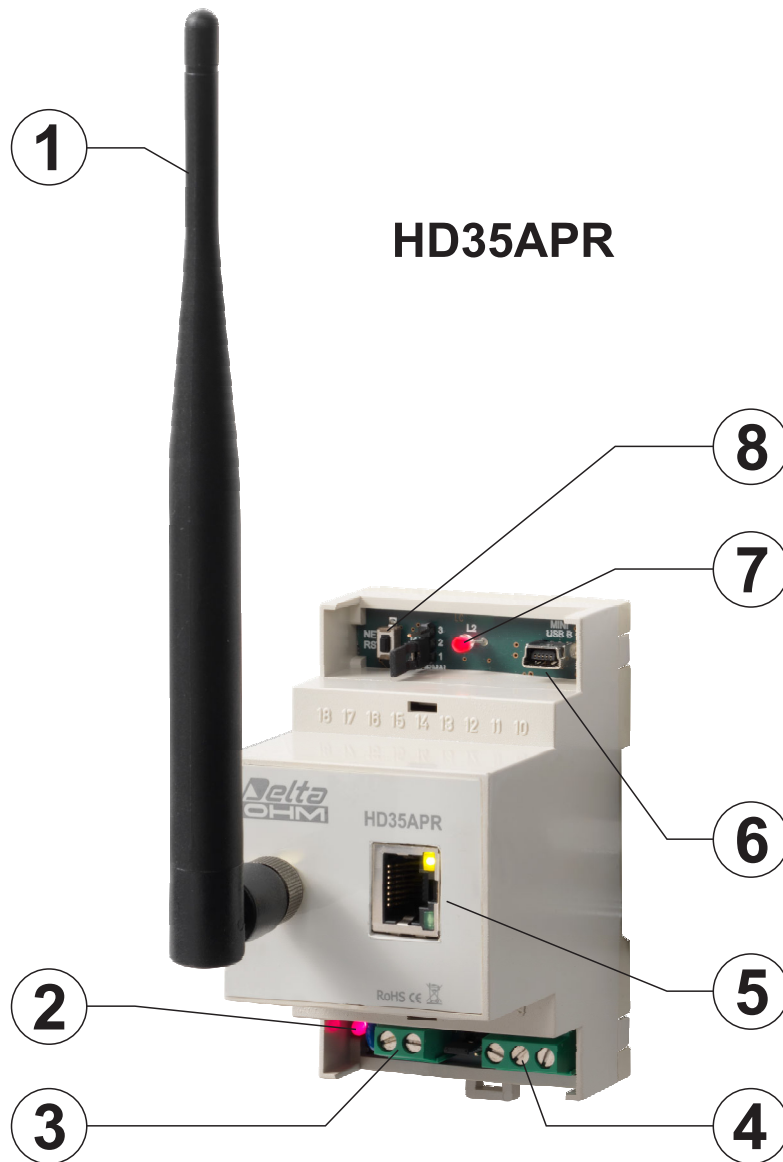

HD35APR

1. RF antenna for transmission in ISM band.
2. POWER LED: in red color, it indicates the presence of an external power supply.
3. Connector for external 8...30 Vdc power supply.
4. RS485 (Modbus-RTU protocol) connector.
5. ETHERNET RJ45 connector.
6. Mini-USB connector for PC connection. The PC USB port powers the instrument in the absence of an external power supply.
7. Bicolor RF LED: it blinks green when the unit is in normal operation mode; it blinks red to signal problems in RF transmission.
8. Button and jumper for restoring the default ETHERNET settings.

6.3 RF LEDs SIGNALS

GREEN LED	RED LED	DESCRIPTION
ON	ON	Initialization phase after a reset or battery connection.
Short blink every 3 s	OFF	Normal operation mode.
Short blink every 3 s	Short blink every 3 s	RF alarm: at least one device exceeded the set PER threshold (Packet Error Rate).
Blinking 1 s ON / 1 s OFF		The unit is changing RF channel.
Blinking 1 s ON / 1 s OFF	Blinking 1 s ON / 1 s OFF	The unit is changing RF channel and signaling an RF alarm (alarm signaling is normal during an RF channel change).
OFF	Blinking 1 s ON / 4 s OFF	Date/time not set. It is necessary to set the clock.
OFF	Blinking 1 s ON / 2 s OFF	There is an error in the user configuration parameters.
OFF	Blinking 1 s ON / 1 s OFF	There is an error in the factory configuration parameters or a hardware component is not working properly.
OFF	OFF	Firmware upload or network file transfer. The RF activity is suspended until upload completion.

6.4 USB CONNECTION

The base units can be connected to a PC through the mini-USB connector and **CP23** cable (directly with type A USB connector for HD35APD). In this connection mode, the base unit is powered through the PC USB port.

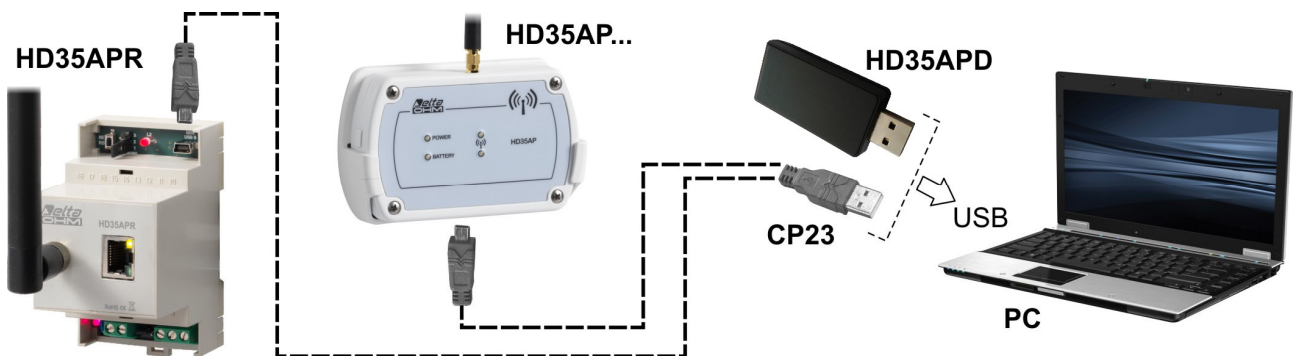

Fig. 6.4.1: USB connection

USB connection doesn't require the installation of drivers: when the base unit is connected to a PC, Windows® operating system automatically recognizes the unit as an HID device (Human Interface Device) and uses the drivers already included in the operating system.

Note: if the external power supply is not used but only the USB connection, it is recommended to connect the unit to a minimum 500 mA USB port to allow a sufficient recharging of the internal battery (only for models with internal battery).

6.5 ETHERNET OR WI-FI CONNECTION

The **HD35APW** base unit can be connected to a PC through an Ethernet or Wi-Fi local network. The choice of the connection mode, Ethernet or Wi-Fi, and of the relevant settings must be performed with the HD35AP-S software. The **HD35APR** base unit can be connected to a PC through an Ethernet local network

In the connection mode through local network, the **HD35APW** base unit must be powered by means of an external power supply, because the internal battery has a few hours life.

For the Ethernet mode, connect the RJ45 connector of the base unit to a local network socket by means of a standard Ethernet cable.

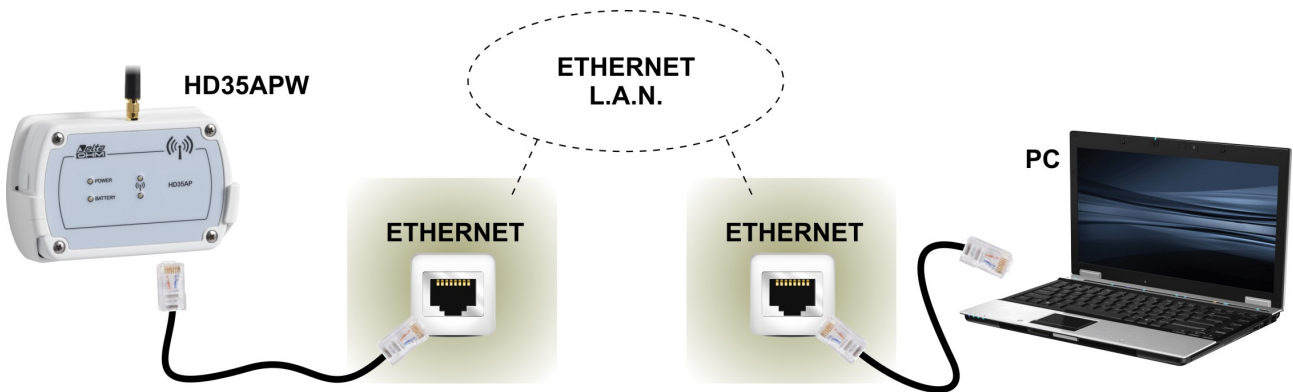

Fig. 6.5.1: ETHERNET connection

In Wi-Fi mode, connect the base unit to an available Wi-Fi network using the HD35AP-S software (see software instructions).

The base unit connects to the router of the local network (Wi-Fi Access Point, in Wi-Fi mode) and works as a **client**-type device. It is possible to set a fixed (static) IP address or configure the DHCP mode (Dynamic Host Configuration Protocol) so as the unit requests a dynamic IP address to the network server/router.

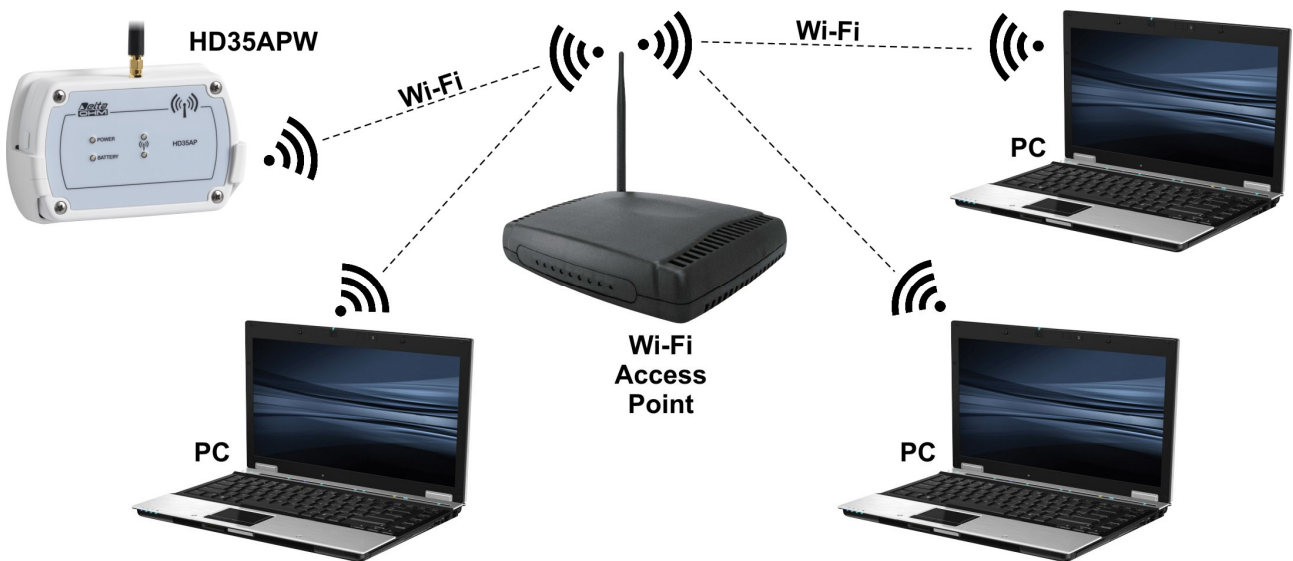

Fig. 6.5.2: base unit in Wi-Fi mode operating as a client

It is possible to access the base unit from any PC of the local network where the basic HD35AP-S software was installed (see the connection procedure presented in chapter " *Connection to base unit* " of the software online help). To access the data downloaded in the database from a PC other than that where the database was installed **you need instead the advanced version of the software HD35AP-PLUS**.

The connection to the base unit is **multi-client**: the unit has two TCP/IP virtual ports and ten sockets in total to be divided between the two ports. Each port can operate with TCP/IP or MODBUS TCP/IP protocol. The ports setting (port number, number of socket assigned and type of protocol) must be performed with the HD35AP-S software (see software instructions). In MODBUS TCP/IP mode, the base unit works as "Modbus TCP/IP gateway".

6.6 RS485 CONNECTION

The **HD35APR** and **HD35APS** base units have a RS485 communication port with **MOD-BUS-RTU** protocol. For connecting the **HD35APS** base unit, use the CPM12-8P... series cables with 8-pole M12 connector. The figure and the table below show the numbering and the function of the connector contacts:

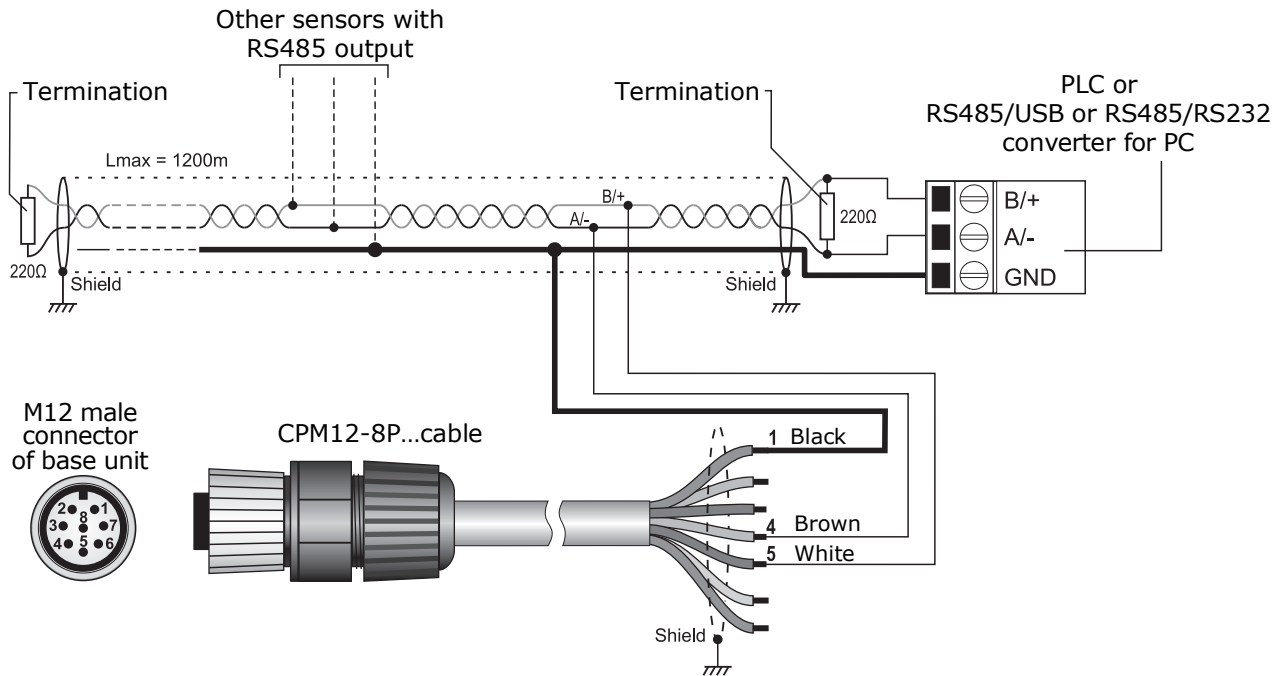

Fig. 6.6.1: RS485 connection

TAB. 6.6.1: CPM12-8P... cable

Connector	Function	Color B
1	GND	Black
2	Not connected	
3	Not connected	
4	RS485 A/-	Brown
5	RS485 B/+	White
6	Not connected	
7	Not connected	
8	Not connected	

Thanks to RS485 connection, several instruments can be connected in a multi-point network. The instruments are connected in sequence by means of a shielded cable with twisted pair wires for signals and a third wire for the ground.

Line terminations must be placed at the ends of the network. The cable shield must be connected to both ends of the line.

The maximum number of devices that can be connected to the line (Bus) RS485 depends on the load characteristics of the devices to be connected. The RS485 standard requires that the total load doesn't exceed 32 (Unit Loads). The load of a base unit HD35APR or HD35APS is equal to 1 unit load. If the total load is higher than 32 unit loads, divide the network in segments and add a signal repeater between a segment and the following. A line termination must be placed at both ends of each segment.

The cable maximum length depends on the transmission speed and on the cable characteristics. Typically, the maximum length is 1200 m. The data line must be kept separated from any power lines to avoid interferences to the transmitted signal.

Each instrument in the RS485 network is univocally identified by an address ranging within 1 and 247. **No more than one transmitter with the same address can be present in the same network.**

Before connecting the base unit to the RS485 network, configure address and Baud Rate (see chapter " *HD35AP... base unit configuration* " of the software *online help*). The communication parameters in the PC/PLC must be the same as those set in the base unit.

6.7 HD35APR CONNECTIONS

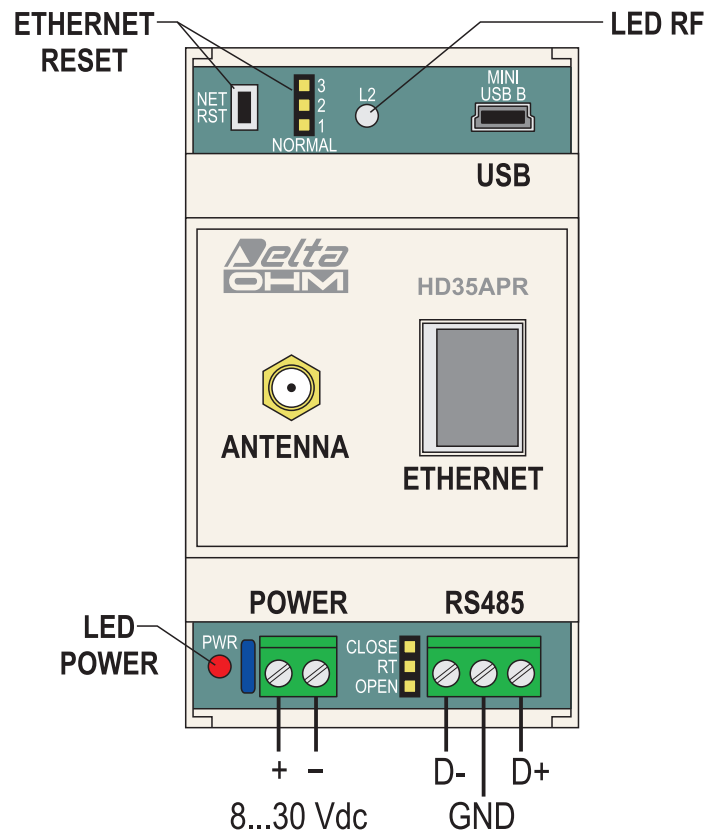

RS485 line termination:

If the instrument is at one end of the RS485 line, insert the termination by placing the short jumper next to the RS485 connector between the "RT" and "CLOSE" indications. Otherwise, remove the termination by placing the short jumper between the "RT" and "OPEN" indications.

Factory ETHERNET settings:

- IP address = 192.168.1.235 static
- Subnet mask = 255.255.255.0
- Ports = 5100 for proprietary TCP protocol (8 sockets), 502 for Modbus TCP/IP protocol (2 sockets)

The ETHERNET settings can be changed with the HD35AP-S software. It is possible to restore the factory parameters by placing the short jumper next to the NET RST push-button between the "2" and "3" indications and then pressing the NET RST push-button. After the reset, replace the short jumper between the "2" and "1 (NORMAL)" indications.

6.8 GSM CONNECTION

In order to use the GSM functionalities of the base unit **HD35APG**, a **SIM** card enabled for data transmission must be inserted into the unit. The card should be requested to a carrier that has an adequate coverage of the GSM network in the place where the base unit will be installed. To insert the card, proceed as follows.

1. Unscrew the 4 front screws on the housing and remove the back cover.
2. Disconnect the battery.
3. Press the release button of the SIM tray and, keeping the button depressed, extract the tray by making it slide upward.

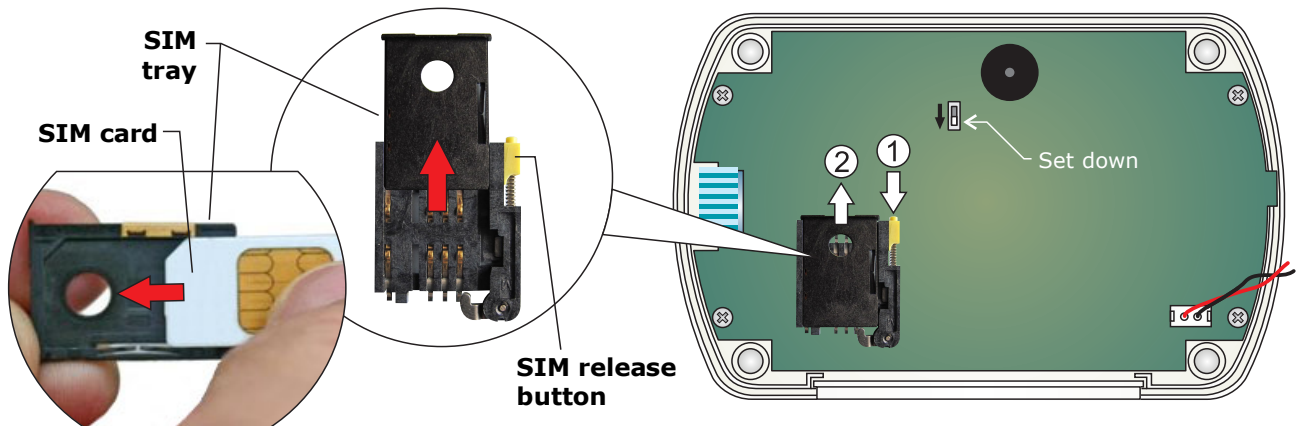

Fig. 6.8.1: inserting the SIM card

4. Insert the SIM card into its tray so as the SIM card contacts face the outside of the tray. The tray is provided with an insertion key that prevents the possibility of inserting the SIM card improperly.
5. Put the SIM tray back in place, making sure that the SIM card contacts face the instrument board.
6. Reconnect the battery.
7. Close again the housing by fixing the 4 front screws.

Through the HD35AP-S software, set the necessary information for GSM operation: SIM PIN, name of the APN access point, e-mail account and addresses, FTP address, telephone numbers, data transmission mode, etc. (see chapter "GSM Options" of the software online help).

6.8.1 SENDING COMMANDS TO THE BASE UNIT FROM A MOBILE PHONE

SMS messages containing commands can be sent by a mobile phone to the HD35APG base unit, to change some GSM settings of the unit. This feature is useful in case a connection to a PC with the base unit is not available.

The SMS must be sent to the number of the SIM card inserted into the base unit.

The following table lists the available commands:

TAB. 6.7.1: SMS commands

Command	Description
RESET	Reset of the base unit
EMAIL-ON	Activates periodic download of measurement data via e-mail
EMAIL-OFF	Deactivates periodic download of measurement data via e-mail

Command	Description
EMAIL-PERIOD= <i>period index</i>	Set the transmission interval via e-mail, where <i>period index</i> : 0->15 min, 1->30 min, 2->1 hour, 3->2 hours, 4->4 hours, 5->8 hours, 6->12 hours, 7->24 hours, 8->2 days, 9->4 days, 10->1 week
EMAIL-FORMAT= <i>format index</i>	Set the format of the data sent via e-mail, where <i>format index</i> : 1->log (format for database), 2->csv (format for Excel®), 3->log+csv
EMAIL-DL-START	Activates immediate data download by e-mail starting from the last measurement transmitted
EMAIL-DL-FROM= <i>YYYY/MM/DD HH:MM:SS</i>	Downloads data by e-mail starting from the specified date, where YYYY: year, MM: month, DD: day, HH: hour, MM: minutes, SS: seconds
EMAIL-DL-INTERVAL= <i>YYYY/MM/DD HH:MM:SS - YYYY/MM/DD HH:MM:SS</i>	Downloads by e-mail all data between the specified dates, where YYYY: year, MM: month, DD: day, HH: hour, MM: minutes, SS: seconds
EMAIL-ALARM-REPORT	Transmits by e-mail a report containing the current measurements of the selected devices for SMS/e-mail alarms
EMAIL-REPORT	Transmits by e-mail a report containing the current measurements of all the network devices
EMAIL-HELP	Transmits an e-mail containing a list of all SMS commands
FTP-ON	Activates the periodic download of measurement data via FTP
FTP-OFF	Deactivates the periodic download of measurement data via FTP
FTP-PERIOD= <i>period index</i>	Set the transmission interval via FTP, where <i>period index</i> : 0->15 min, 1->30 min, 2->1 hour, 3->2 hours, 4->4 hours, 5->8 hours, 6->12 hours, 7->24 hours, 8->2 days, 9->4 days, 10->1 week
FTP-FORMAT= <i>format index</i>	Set the format of the data sent via FTP, where <i>format index</i> : 1->log (format for database), 2->csv (format for Excel®), 3->log+csv
FTP-DL-START	Activates immediate data download by FTP starting from the last measurement transmitted
FTP-DL-FROM= <i>YYYY/MM/DD HH:MM:SS</i>	Downloads data via FTP starting from the specified date, where YYYY: year, MM: month, DD: day, HH: hour, MM: minutes, SS: seconds
FTP-DL-INTERVAL= <i>YYYY/MM/DD HH:MM:SS - YYYY/MM/DD HH:MM:SS</i>	Downloads by FTP all data between the specified dates, where YYYY: year, MM: month, DD: day, HH: hour, MM: minutes, SS: seconds
FTP-ALARM-REPORT	Transmits by FTP a report containing the current measurements of the selected devices for SMS/e-mail alarms
FTP-REPORT	Transmits by FTP a report containing the current measurements of all the network devices
FTP-HELP	Transmits by FTP a file containing a list of all SMS commands
SMS-ALARM-ON	Activates the transmission of alarm SMS for the overrun of the measurement thresholds for the selected devices
SMS-ALARM-OFF	Deactivates the transmission of alarm SMS for the overrun of the measurement thresholds for the selected devices
SMS-RF-ALARM-ON	Activates the transmission of alarm SMS for RF problems in the selected devices
SMS-RF-ALARM-OFF	Deactivates the transmission of alarm SMS for RF problems
EMAIL-ALARM-ON	Activates the transmission of e-mail alarms when the selected devices have measurements in alarm
EMAIL-ALARM-OFF	Deactivates the transmission of e-mail alarms for measurement alarms
EMAIL-RF-ALARM-ON	Activates the transmission of e-mail alarms when the selected devices have RF problems
EMAIL-RF-ALARM-OFF	Deactivates the transmission of e-mail alarms for RF problems
SMS-ALARM-REPORT	Transmits by SMS the list of the devices in alarm condition. Only the selected devices are taken into consideration for SMS alarms
SMS-DEVICE-ALARM-REPORT= <i>RF address</i>	Transmits via SMS a report of the measurements selected for SMS alarms, of the device with specified RF address

Command	Description
SMS-DEVICE-REPORT= <i>RF address</i>	Transmits via SMS a report of the measurements of the device with specified RF address
SMS-HELP	Transmits an SMS containing the list of all SMS commands
TCP-SERVER-ON	Activates a TCP connection with AP acting as a TCP server
TCP-SERVER-OFF	Deactivates the TCP connection with AP acting as a TCP server
TCP-CLIENT-ON	Activates a TCP connection with AP acting as a TCP client
TCP-CLIENT-OFF	Deactivate the TCP connection with AP acting as a TCP client
TCP-SERVER-ADDRESS= " <i>server address</i> "	Specifies the server address for TCP connection when AP acts as TCP client. The server-address string can be a domain or a IP address
TCP-SERVER-PORT= <i>port number</i>	Specifies the number of the TCP port used by the remote server to accept connections with AP when AP acts as TCP client
TCP-LISTEN-PORT= <i>port number</i>	Specifies the number of the TCP listening port used by AP when AP acts as TCP server
ADD-PHONE= " <i>phone number</i> "	Adds a phone number to the list of numbers considered for SMS alarms
CANC-PHONE	Delete my phone number and don't consider it any more for SMS alarms. The primary phone number cannot be deleted
ERASE-PHONE= <i>phone number index</i>	Deletes the phone number with specified index. This command is accepted only by the primary phone number

Up to 16 commands can be written in the same text message, separated by spaces or commas.

For safety, commands are executed only if they are coming from the cell numbers set in the HD35AP-S software and if the SMS text starts with a user-defined key word. The key word is set through the HD35AP-S software, going to the menu " *GSM options* " at the item " *SMS recipients* " and setting the field " *SMS keyword* " (see chapter " *GSM settings* " of the software online help).

Example: supposing you entered the string ">>>" in the *SMS keyword* field and you wish to activate periodic download via e-mail of the measured data with an interval of 1 hour, you will have to send the following text message:

>>> EMAIL-ON EMAIL-PERIOD=2

With the commands EMAIL-HELP, FTP-HELP and SMS-HELP you can ask the base unit to send respectively by e-mail, to an FTP address and through SMS the complete list of the available SMS commands. This function is useful especially if you don't have the manual at hand, or to obtain the updated command list following the base unit firmware updates.

6.8.2 GPRS TCP/IP CONNECTION

Through GPRS TCP/IP protocol, it is possible to interact with the HD35APG base unit from a remote PC with an Internet connection.

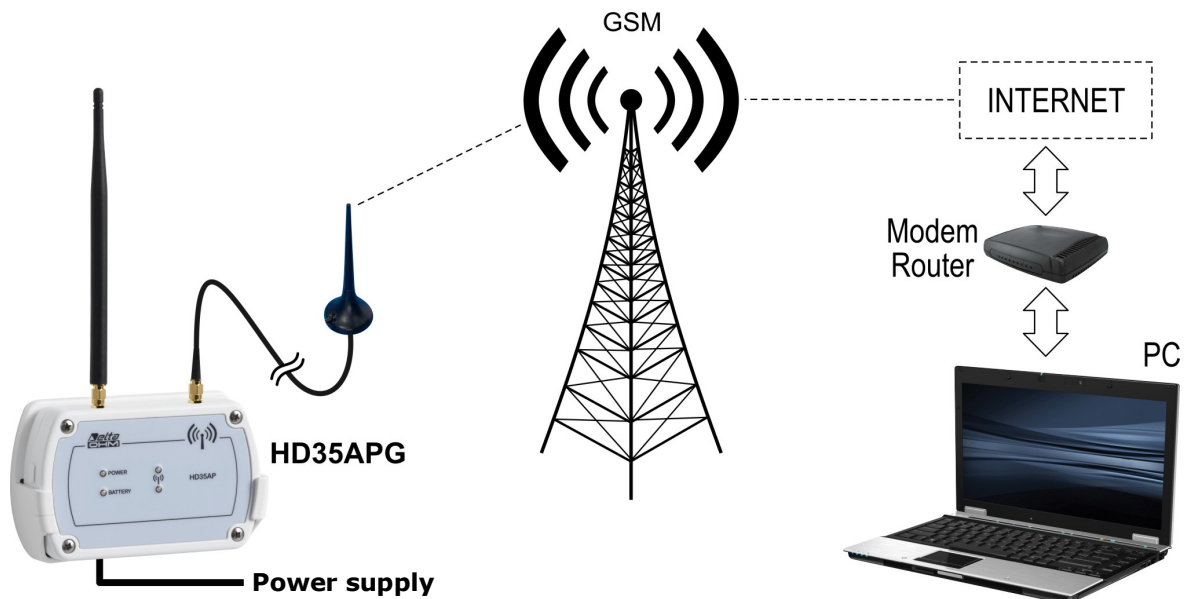

Fig. 6.8.2: GPRS TCP/IP connection

The connection can be of two types:

1) **HD35APG = Client , PC = Server**

HD35APG acts as TCP client and requests the connection to the PC, the PC acts as TCP server and waits for the connection request. The server IP address (PC or Router) must be public and can be either static or dynamic; if the IP address is dynamic, it is convenient to register the server to a DDNS (Dynamic Domain Name System) service.

2) **HD35APG = Server , PC = Client**

The PC acts as TCP client and requests the connection to HD35APG, HD35APG acts as TCP server and waits for the connection request. The server IP address (HD35APG) must be public and static.

Connection HD35APG = Client , PC = Server

1. Open a port (port forwarding) in the Modem/Router through which your PC connects to Internet (follow the instructions of your Modem/Router).
2. Connect HD35APG to a PC USB port and perform the connection procedure with the HD35AP-S software.
3. In the HD35AP-S software select *Instruments setup >> GSM options >> GPRS TCP/IP client settings* and set the server IP address or domain name and port number (number of the port opened in the Modem/Router).
4. Disconnect HD35APG from the USB port.
5. In the HD35AP-S software select *Tools >> Type of connection*, select the *TCP server* option and set the number of the port opened in the Modem/Router.
6. In the HD35AP-S software, select the *Connect* icon.
7. Send to HD35APG the SMS command **TCP-CLIENT-ON**.

If the connection is not established within 30 minutes after sending the SMS command TCP-CLIENT-ON, the command must be sent again.

Alternatively, the server IP address or domain name and port number can be set in HD35APG without connecting HD35APG to the PC and without the HD35AP-S software by using the SMS commands **TCP-SERVER-ADDRESS** and **TCP-SERVER-PORT**.

Connection HD35APG = Server , PC = Client

1. Open a listening port in HD35APG by using the SMS command **TCP-LISTEN-PORT** (for example, TCP-LISTEN-PORT=2020).
2. Send to HD35APG the SMS command **TCP-SERVER-ON**.
3. HD35APG replies with a first SMS to confirm that the command has been accepted. Wait for a second SMS with the confirmation that the *TCP server* functionality has been activated and with the IP address (and port number) assigned to HD35APG.
4. In the HD35AP-S software select *Tools >> Type of connection*, select the *TCP client* option and set the IP address and port number of HD35APG.
5. In the HD35AP-S software, select the *Connect* icon.

If the connection is not established within 1 hour after sending the SMS command TCP-SERVER-ON, the command must be sent again.

6.9 TECHNICAL FEATURES OF BASE UNITS HD35AP – HD35APG – HD35APS – HD35APW

<i>Transmission frequency</i>	868 MHz, 902-928 MHz or 915.9-929.7 MHz (not for HD35APG) according to the model
<i>Antenna</i>	External whip antenna
<i>Transmission range</i>	In open field: 300 m (E, J)/ 180 m (U) towards data loggers with internal antenna. > 500 m (E, J, U) towards repeaters and data loggers with external antenna. (could be reduced in presence of obstacles or adverse atmospheric conditions)
<i>Serial outputs</i>	USB with Mini-USB connector (CP23 cable) RS485 with MODBUS-RTU protocol (HD35APS only)
<i>Ethernet connection</i>	Only in HD35APW model. Permits (if the Internet connection is available) sending alarm e-mail and the recorded data via e-mail or to an FTP address (**). Allows the MODBUS TCP/IP protocol. With integrated Web server.
<i>Wi-Fi connection</i>	Only in HD35APW model. Permits (if the Internet connection is available) sending alarm e-mail and the recorded data via e-mail or to an FTP address (**). Allows the MODBUS TCP/IP protocol. With integrated Web server.
<i>GSM connection</i>	HD35APG model only. For the transmission of alarm e-mail or SMS and data by e-mail or FTP (**). Allows GPRS TCP/IP protocol.
<i>Internal memory</i>	The number of storable samples depends on the type of data loggers connected. The capacity is of 226,700 samples if all data loggers record 7 quantities.
<i>LED indicators</i>	Presence of external power supply, battery charge level, RF communication status.
<i>Power supply</i>	Internal lithium-ion 3.7 V rechargeable battery, 2250 mA/h capacity, JST 3-pole connector Optional external 6 Vdc power supply (SWD06) Directly powered by a PC USB port (*)
<i>Current consumption</i>	30 mA without Ethernet/Wi-Fi and with typical GSM activity (**) 160 mA with Ethernet, 275 mA with Wi-Fi
<i>Battery life (typical)</i>	3 days if not connected to local network and with typical GSM activity (**) 11 hours with Ethernet, 8 hours with Wi-Fi
<i>Operating temperature and humidity</i>	-10...+60 °C / 0...85 %RH non condensing
<i>Dimensions</i>	See dimensional drawings
<i>Weight</i>	About 200 g (battery included)
<i>Housing</i>	LURAN® S 777K
<i>Installation</i>	Wall support (supplied) for removable installation or flanges (option) for fixed installation

(*) The connection of the SWD06 external power supply is recommended if the Ethernet, Wi-Fi or GSM transmission is used.

(**) The intensive use of the GSM transmission can significantly increase the power consumption and reduce the battery life.

(***) In the basic version, the data are sent via FTP with an interval of not less than 2 minutes and only if in the network there are up to 5 data loggers. For the full FTP functionality, the PLUS option has to be requested.

6.10 TECHNICAL FEATURES OF BASE UNIT HD35APD

<i>Transmission frequency</i>	868 MHz or 902-928 MHz depending on the model (915.9-929.7 MHz not available)
<i>Antenna</i>	Internal
<i>Transmission range</i>	In open field: 180 m (E, U) (could be reduced in presence of obstacles or adverse atmospheric conditions)
<i>Output</i>	USB with A type connector
<i>Internal memory</i>	The number of storable samples depends on the type of data loggers connected. The capacity is of 226,700 samples if all data loggers record 7 quantities.
<i>LED indicators</i>	RF communication status
<i>Power supply</i>	Directly powered by a PC USB port
<i>Operating temperature and humidity</i>	-10...+60 °C / 0...85 %RH non condensing
<i>Dimensions</i>	62 x 25,5 x 13,2 mm

6.11 TECHNICAL FEATURES OF BASE UNIT HD35APR

<i>Power supply</i>	8...30 Vdc
<i>Power consumption</i>	40 mA @ 24 Vdc
<i>Internal battery</i>	No
<i>Transmitting frequency</i>	868 MHz, 902-928 MHz or 915.9-929.7 MHz depending on the model
<i>Antenna</i>	Whip external
<i>Transmitting range</i>	In open field: 300 m (E, J)/ 180 m (U) towards data loggers with internal antenna. > 500 m (E, J, U) towards repeaters and data loggers with external antenna. (could be reduced in presence of obstacles or adverse atmospheric conditions)
<i>Serial outputs</i>	USB with Mini-USB type connector (cable CP23) RS485 with MODBUS-RTU protocol
<i>Ethernet connection</i>	Yes. Permits (if the Internet connection is available) sending alarm e-mail and the recorded data via e-mail or to an FTP address (***) . Allows the MODBUS TCP/IP protocol. With integrated Web server.
<i>Wi-Fi connection</i>	No
<i>GSM connection</i>	No
<i>Internal memory</i>	The number of samples that can be stored depends on the type of data loggers connected. The capacity is 226,700 samples if all the data loggers record 7 quantities.
<i>LED indicators</i>	Presence of external power supply, RF communication status.
<i>Working temperature and humidity range</i>	-10...+60 °C / 0...85 %RH not condensing
<i>Dimensions</i>	See dimensional drawing
<i>Weight</i>	200 g approx.
<i>Installation</i>	35 mm DIN rail

7 HD35RE... REPEATERS

7.1 AVAILABLE VERSIONS

- **HD35RE:** In housing for indoor use, with external power supply and rechargeable internal backup battery.
- **HD35REW:** In IP 67 waterproof housing, with internal not rechargeable battery.

7.2 DESCRIPTION OF HD35RE IN HOUSING FOR INDOOR USE

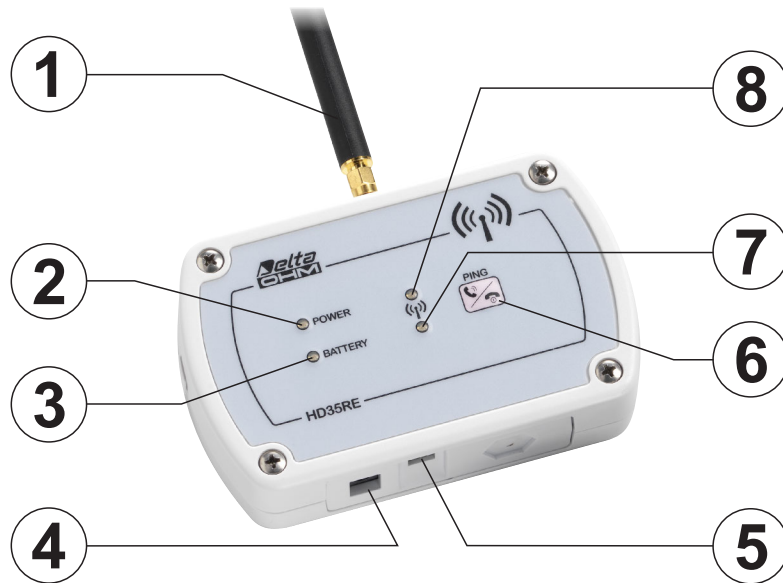

1. RF Antenna.
2. POWER LED: red color, it indicates the presence of the external power supply; it blinks if the battery is charging.
3. BATTERY LED: green color, it indicates the internal battery charge level. When the indicator light is steady on, the battery is fully charged; as the battery is running low, the LED blinks with a lower and lower frequency (the blink period increases of 1 second for each 10% decrease of the battery charge).
4. Connector for external 6 Vdc power supply (**SWD06**).
5. Mini-USB connector for PC connection. Use reserved for technical assistance.
6. Connection / PING (for testing RF) button.
7. Green RF LED: it blinks if the data transmission was successful.
8. Red RF LED: it blinks to signal that data transmission has failed.

The green and red RF LEDs blink simultaneously if the device is in error condition.

Power supply: since the repeater is normally not always connected to a computer, it is advisable to use an external power supply, since the internal battery life is of a few days.

7.3 DESCRIPTION OF HD35REW IN WATERPROOF HOUSING



1. RF Antenna.
2. BATTERY LED: green color, it indicates the internal battery charge level. As the battery is running low, the LED blinks with a lower and lower frequency (the blink period increases of 1 second for each 10% decrease of the battery charge).
3. ALARM LED: not used.
4. Red RF LED: it blinks to signal that data transmission has failed.
5. Green RF LED: it blinks if the data transmission was successful.

The green and red RF LEDs blink simultaneously if the device is in error condition.

7.4 CONNECTION TO THE WIRELESS NETWORK

The device can be connected and disconnected to/from the wireless network by **pressing for 5 seconds**:

- the connection button on the front panel, for HD35RE (see point 6 of paragraph 7.1);
- the internal connection button, for HD35REW (see the following figure).

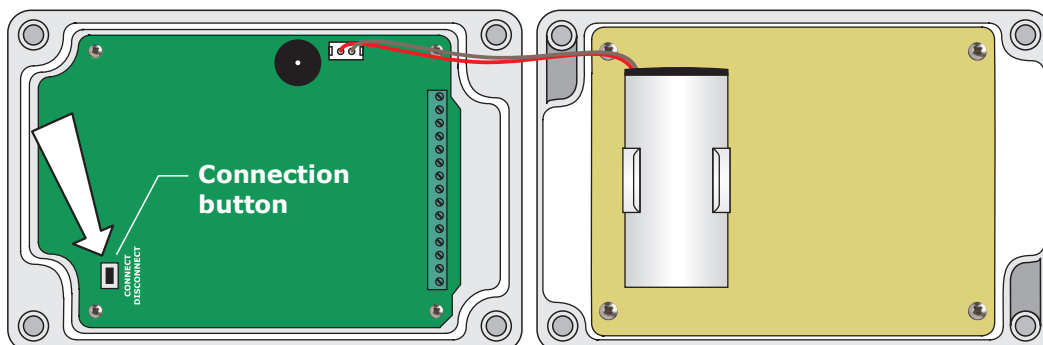

Fig. 7.4.1: HD35REW internal connection button

If the device is disconnected, by pressing the connection button for 5 seconds the buzzer emits a beep and the green LED activates for one second to indicate the start of the connection procedure. If the device belongs to a wireless network and the base unit is reachable, once connected, the buzzer emits a second beep and the green RF LED will blink during data transmis-

sion. If the device doesn't belong to a wireless network or the base unit cannot be reached, the second beep of the buzzer is not emitted and the red RF LED will blink.

If the device is connected, by pressing the connection button for 5 seconds the buzzer emits a beep, the red RF LED activates for one second and the device is disconnected.

PING function:

In the devices connected to a wireless network it is possible to check if the base unit can be reached by briefly pressing the connection button: if the green RF LED is blinking, it means that the base unit is reachable, otherwise it will be the red RF LED to blink.

7.5 ARRANGEMENT OF THE REPEATERS

Designing the system it should be taken into account that between a HD35REW repeater and a HD35ED... data logger or between two HD35REW repeaters, only HD35REW repeaters can be interposed, as shown in following examples.

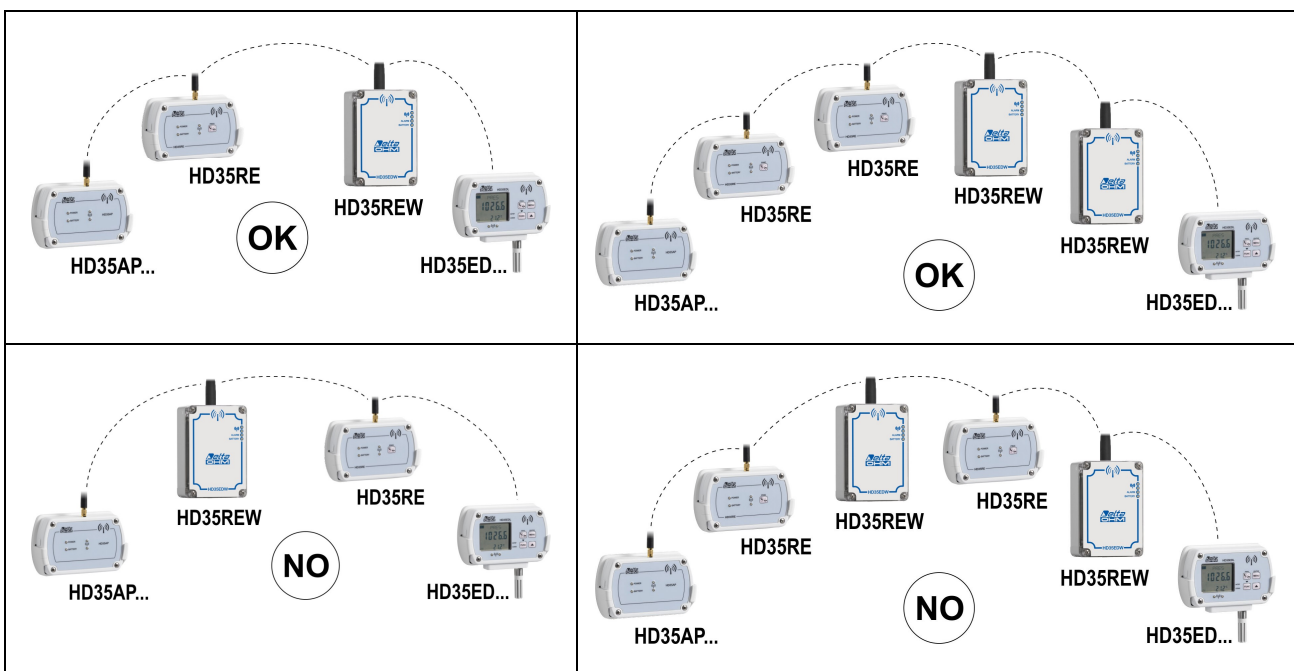

Fig. 7.5.1: arrangement of different types of repeaters

Unlike HD35RE repeaters, which have external power supply, the HD35REW repeaters are powered only by the internal battery. To extend the battery life, the RF stage of the HD35REW repeaters is not continuously active; therefore, the HD35REW repeaters are subject to the following restrictions:

- the alarm events may be reported with a certain delay;
- the adding of new devices to the wireless network must be done near the HD35AP.. base unit, without interposing HD35REW repeaters between the new devices and the base unit;
- the reconfiguration of the system may take longer; furthermore, if the configuration of a data logger with LCD is changed via the logger keyboard, the change is not notified to the base unit and to the HD35AP-S software.

7.6 TECHNICAL FEATURES OF THE REPEATER HD35RE

<i>Transmission frequency</i>	868 MHz, 902-928 MHz or 915.9-929.7 MHz according to the model
<i>Antenna</i>	External whip antenna
<i>Transmission range</i>	In open field: 300 m (E, J)/ 180 m (U) towards data loggers with internal antenna. > 500 m (E, J, U) towards base unit (except HD35APD), repeaters and data loggers with external antenna. 180 m (E, U) towards base unit HD35APD. (could be reduced in presence of obstacles or adverse atmospheric conditions)
<i>Serial outputs</i>	USB with Mini-USB connector (CP23 cable) Only for configuration and firmware update, not for data download
<i>LED indicators</i>	Presence of external power supply, battery charge level, RF communication status.
<i>Keyboard</i>	Connection / PING (for testing RF) button
<i>Power supply</i>	Internal lithium-ion 3.7 V rechargeable battery, 2250 mA/h capacity, JST 3-pole connector Optional external 6 Vdc power supply (SWD06) Directly powered by a PC USB port
<i>Current consumption</i>	30 mA
<i>Battery life</i>	Typically 3 days
<i>Operating temperature and humidity</i>	-10...+60 °C / 0...85 %RH non condensing
<i>Dimensions</i>	See dimensional drawing
<i>Weight</i>	About 200 g (battery included)
<i>Housing</i>	LURAN® S 777K
<i>Installation</i>	Wall support (supplied) for removable installation or flanges (option) for fixed installation

7.7 TECHNICAL FEATURES OF THE REPEATER HD35REW

<i>Transmission frequency</i>	868 MHz, 902-928 MHz or 915.9-929.7 MHz according to the model
<i>Antenna</i>	External whip antenna
<i>Transmission range</i>	In open field: 300 m (E, J)/ 180 m (U) towards data loggers with internal antenna. > 500 m (E, J, U) towards base unit (except HD35APD), repeaters and data loggers with external antenna. 180 m (E, U) towards base unit HD35APD. (could be reduced in presence of obstacles or adverse atmospheric conditions)
<i>LED indicators</i>	Battery charge level, RF communication status.
<i>Push-buttons</i>	Push-button for connection inside the instrument
<i>Power supply</i>	Internal 3.6 V lithium-thionyl chloride (Li-SOCl ₂) not rechargeable battery, capacity 8400 mA/h, size C, Molex 5264 2-pole connector
<i>Battery life</i>	2 years typical (repeating the signal of 5 data loggers transmitting every 30 s)
<i>Operating temperature and humidity</i>	-20...+70 °C / 0...100 %RH not condensing
<i>Dimensions</i>	See dimensional drawing
<i>Weight</i>	About 250 g (battery included)
<i>Housing</i>	Polycarbonate
<i>Protection degree</i>	IP 67
<i>Installation</i>	Wall mounted or fixed to the 40 mm diameter mast by means of the HD2003.77/40 clamping (optional). Protection shield from solar radiations HD9217TF1 (optional) for outdoor installation.

8 HD35ED... DATA LOGGERS FOR INDOOR USE

8.1 DESCRIPTION

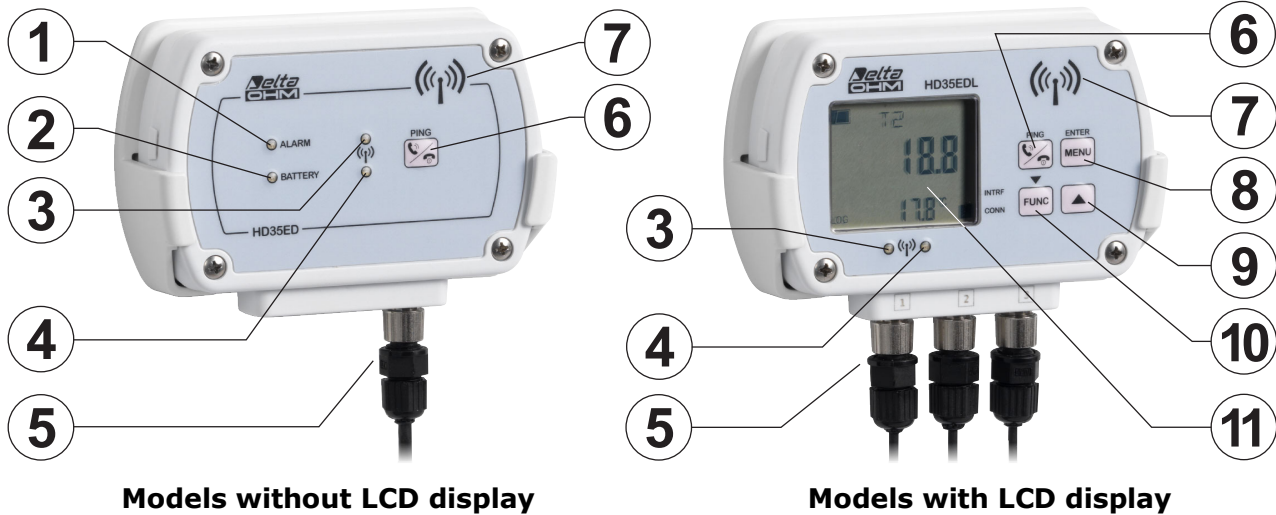

1. ALARM LED: red color; it blinks when a measurement is in alarm condition.
2. BATTERY LED: green color, it indicates the internal battery charge level. As the battery is running low, the LED blinks with a lower frequency (the blinking period increases of 1 second for each 10% decrease of the battery charge).
3. Red RF LED: it blinks to signal that data transmission has failed.
4. Green RF LED: it blinks when the data transmission has been successful.
5. Probes and/or integrated sensors. The aspect of the lower part of the data logger depends on the model (see the following page).
6. Connection / PING (for testing RF) button.
7. Internal RF antenna.
8. MENU/ENTER key: allows access to the configuration menu; confirm the selected option or the set value in the menu.
9. ▲ key: in normal operation, it scrolls the quantities measured by the data logger; it scrolls upwards the available options or decreases the set value in the menu.
10. FUNC/▼ key: in normal operation, it displays the maximum (MAX), the minimum (MIN) and the average (AVG) of the measurements; it scrolls downwards the available options or decreases the set value in the menu.
11. LCD Display. The type of display, custom or graphic, depends on the model.

The green and red RF LEDs blink simultaneously if the device is in error condition.

Note: some models of data loggers may be equipped with mini-USB connector, on the housing side, whose use is reserved to the technical assistance.

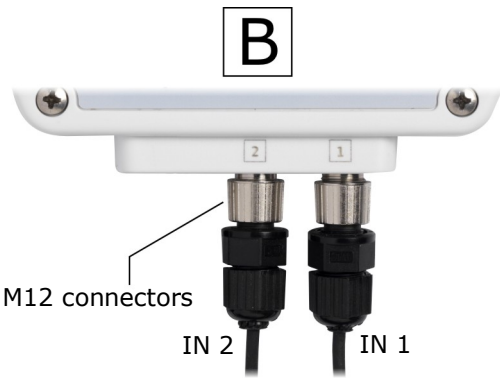
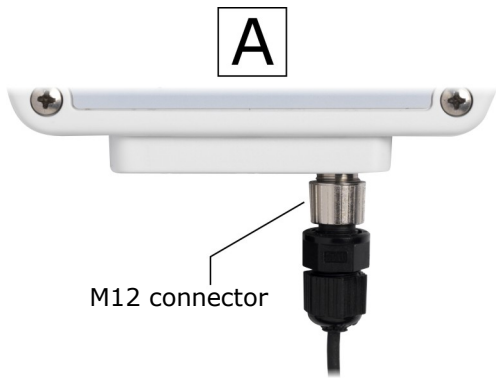

Model	Connectable probes
HD35ED7P/1TC	TP35... (Pt100 / Pt1000)
HD35EDN/1TC	TP35N... (NTC)
HD35ED1NTC	HP3517TC... / TP35N... (NTC)
HD35ED17PTC	HP3517ETC...
HD35ED14bNTC	HP3517TC... / TP35N... (NTC)

Model	Connectable probes	
HD35ED7P/2TC	TP35... (Pt100 / Pt1000)	
HD35EDN/2TC	TP35N... (NTC)	
HD35ED1N/2TC	IN 1	HP3517TC... TP35N... (NTC)
	IN 2	TP35N... (NTC)

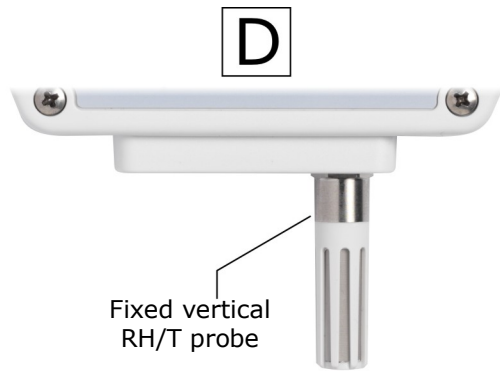
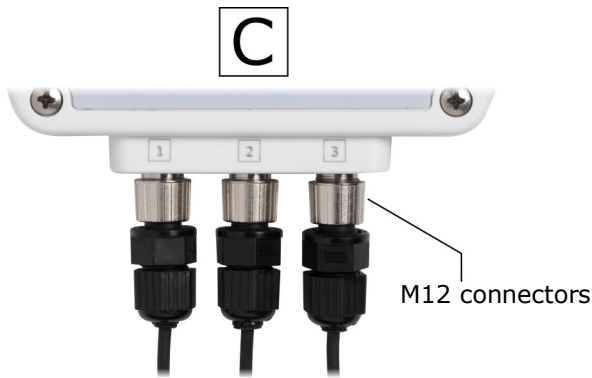

Model	Connectable probes
HD35ED7P/3TC	TP35... (Pt100 / Pt1000)
HD35EDN/3TC	TP35N... (NTC)

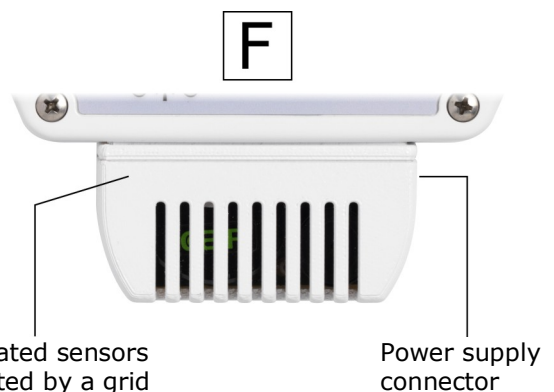
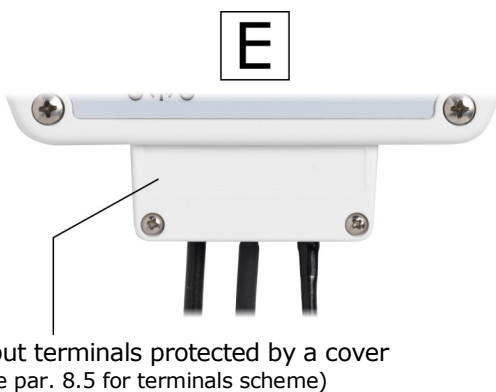

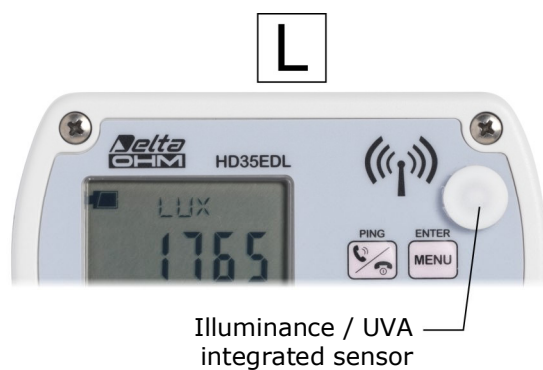
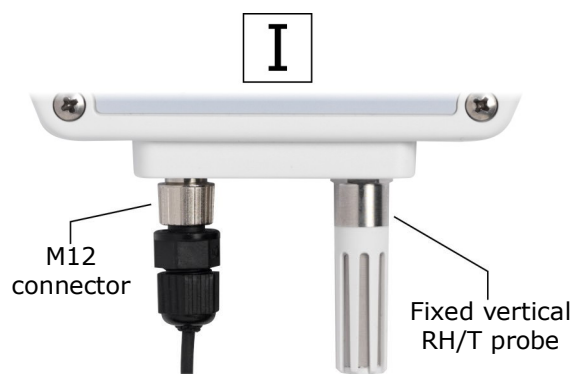
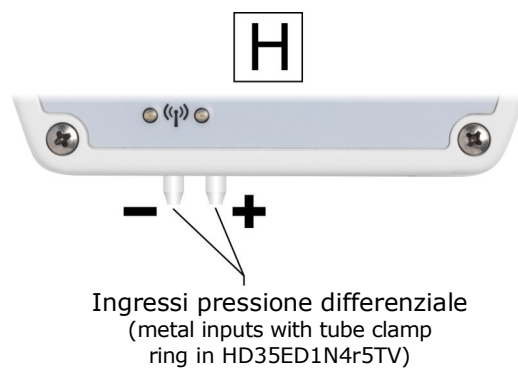
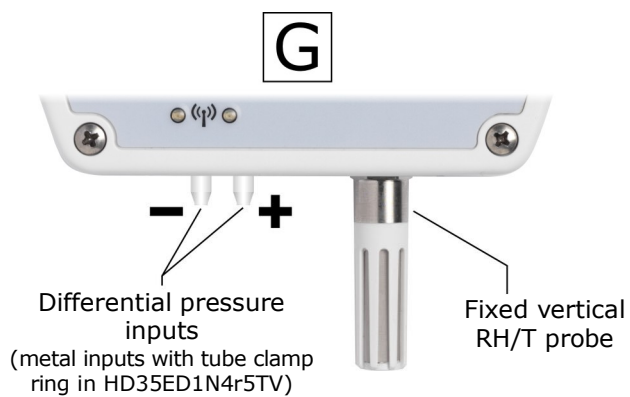









Model	Connectable probes
HD35ED1N/2TC	TP35N... (NTC)
HD35ED1NITCV	LP35PHOT
HD35ED1NI2TCV	LP35PHOT
HD35ED14bNITCV	LP35PHOT
HD35ED14bNI2TCV	LP35PHOT
HD35ED1NUBTCV	LP35UVB
HD35ED1NUCTCV	LP35UVC
HD35ED14bNIUTCV	LP35P-A

Data logger models in indoor-use housing

In order to highlight the physical quantities measured by data loggers, order codes include some identification characters for the various quantities, according to the following convention:

	1 = Humidity
	4b = Atmospheric pressure (barometer)
	4 = Differential pressure (4r1 = range 1, 4r2 = range 2, etc.)
	N = Temperature with NTC10K sensor (N/1 = 1 channel, N/2 = 2 channels, N/3 = 3 channels)
	7P = Temperature with Pt100/Pt1000 sensor (7P/1 = 1 channel, 7P/2 = 2 channels, 7P/3 = 3 channels)
	A = Carbon monoxide (CO)
	B = Carbon dioxide (CO ₂)
	I = Illuminance low range (0...20,000 lux), I2 = Illuminance high range (0...200,000 lux)
	U = UV irradiance (U =UVA, UB =UVB, UC =UVC)

TC = Probe with cable

TV = Fixed vertical temperature and/or R.H. probe without cable (R.H. sensor can be calibrated by user)

TVI = Fixed vertical temperature and R.H. probe without cable (R.H. sensor can not be calibrated by user)

TCV = Illuminance/UV irradiance or temperature only probe with cable and fixed vertical temperature/R.H. probe without cable (R.H. sensor can be calibrated by user)

Models measuring temperature and humidity with a combined probe with cable (...**TC** models) use the probes of the **HP3517...** series with **relative humidity sensor that can be calibrated by user** and NTC 10KΩ @ 25 °C or Pt100 temperature sensor according to the model. **Replacement of the HP3517... probe requires recalibration of the instrument in line with the new probe.**

Models with M12 connectors provided with inputs for the measurement of temperature only, use temperature probes of the **TP35...** series with NTC 10KΩ @ 25 °C or Pt100/Pt1000 sensor.

In models with 2 or 3 M12 connectors, the input number is indicated above the connector.

In models for the measurement of the atmospheric pressure, the sensor is inside the instrument.

In models for the measurement of the differential pressure, please pay attention to the polarity indicated next to connections.









TAB. 8.1.1: differential pressure measuring ranges









Model	Measuring range
HD35ED...4r1...	-2.5...+2.5 hPa (mbar)
HD35ED...4r2...	-10...+10 hPa (mbar)
HD35ED...4r3...	-100...+100 hPa (mbar)
HD35ED...4r4...	-2000...+2000 hPa (= 2 bar)
HD35ED...4r5... (*)	-125...+125 Pa (for clean rooms)

(*) The model r5 measures dynamic pressures (not suitable for the measurement of static pressures) and requires a small air flow between the two pressure inputs. Metal inputs with tube clamp ring to minimize pressure losses.

For the probes connection mode and the position of the integrated sensors in the various models, refer to the figures indicated in the last column of the following table.

TAB. 8.1.2: data logger models in indoor-use housing

Model	MEASUREMENTS									OPTIONAL LCD		INPUTS		Fig.
										L	G	Conn. M12	Built-in sensors	
	NTC 10K	Pt100 Pt1000	RH	Patm	ΔP	Lux	UV	CO	CO ₂	Custom	Graphic			
HD35ED 7P/1 TC		•									•	1		A
HD35ED 7P/2 TC		•									•	2		B
HD35ED 7P/3 TC		•									•	3		C
HD35ED N/1 TC	•									•		1		A
HD35ED N/2 TC	•									•		2		B
HD35ED N/3 TC	•									•		3		C
HD35ED N TV	•									•			•	D
HD35ED 1 TV			•							•			•	D
HD35ED 1 TVI			•							•			•	D
HD35ED 1N TC	•		•							•		1		A
HD35ED 17P TC		•	•							•		1		A
HD35ED 1N TV	•		•							•			•	D
HD35ED 1N TVI		Sensor integrated in RH module	•							•			•	D
HD35ED 1N/2 TC	•		•							•		2		B
HD35ED 1N/2 TCV	•		•							•		1	T / RH	I
HD35ED 14bN TC	•		•	•						•		1	Patm	A
HD35ED 14bN TV	•		•	•						•			•	D
HD35ED 14bN TVI		Sensor integrated in RH module	•	•							•		•	D
HD35ED 1N4r...TV ^(*)	•		•		•					•			•	G
HD35ED 4r... ^(*)					•					•			•	H
HD35ED 1NI TCV	•		•			•				•		1	T / RH	I
HD35ED 1NI2 TCV	•		•			•				•		1	T / RH	I
HD35ED 1NI TV	•		•			•				•			•	D, L
HD35ED 14bNI TCV	•		•	•		•				•		1	T / RH Patm	I
HD35ED 14bNI2 TCV	•		•	•		•				•		1	T / RH Patm	I
HD35ED 14bNI TV	•		•	•		•				•			•	D, L
HD35ED 1NIU TCV	•		•			•	UVA			•		1	T / RH	I
HD35ED 1NIU TV	•		•			•	UVA			•			•	D, L
HD35ED1NUBTCV	•		•				UVB			•		1	T / RH	I
HD35ED1NUCTCV	•		•				UVC			•		1	T / RH	I

Model	MEASUREMENTS									OPTIONAL LCD		INPUTS		Fig.
										L	G	Conn. M12	Built-in sensors	
	NTC 10K	Pt100 Pt1000	RH	Patm	ΔP	Lux	UV	CO	CO ₂	Custom	Graphic			
HD35ED 14bNIU TCV	•		•	•		•	UVA			•		1	T / RH Patm	I
HD35ED 14bNIU TV	•		•	•		•	UVA			•			•	D, L
HD35ED 1NB	Sensor integrated in RH module		•						•		•		•	F
HD35ED 1NAB			•					•	•		•		•	F
HD35ED 14bNAB			•	•					•	•		•		•
HD35ED H	Transmitters with 0÷20 mA, 4÷20 mA, 0÷50 mV or 0÷1 V output Pt100 / Pt1000 Sensors, K, J, T, N, E thermocouples Sensors with voltage-free contact or potentiometric output										•	3 terminal inputs		E

(*) Please refer to table 8.1.1 for the available ranges.

8.2 CONNECTION TO WIRELESS NETWORK

The device can be connected and disconnected from the wireless network by **pressing for 5 seconds** the connection button on the front panel (see point 6 of paragraph 8.1).

If the device is disconnected, by pressing the connection button for 5 seconds the buzzer emits a beep and the green RF LED blinks for one second to indicate the start of the connection procedure. If the device belongs to a wireless network and the base unit is reachable, once connected, the buzzer emits a second beep and the green RF LED will blink during data transmission. If the device doesn't belong to a wireless network or the base unit cannot be reached, the second beep of the buzzer is not emitted and the red RF LED will blink.

If the device is connected, by pressing the connection button for 5 seconds the buzzer emits a beep, the red RF LED activates for one second and the device is disconnected.

In data loggers with LCD display, the connection status is signaled also by the connection icon on the display (see figure 3.6 at page 10):

- the icon is steady on if the data logger is connected;
- the icon blinks if the data logger is trying to connect (the icon will be steady on once connected or will go on blinking if the base unit is not reachable or the data logger doesn't belong to a wireless network);
- if the data logger is not connected, the icon has the aspect of a hang up phone in data loggers with graphic LCD, and it is off in data loggers with custom LCD.

PING function:

In the devices connected to a wireless network it is possible to check if the base unit can be reached by briefly pressing the connection button: if the green RF LED is blinking, it means that the base unit is reachable, otherwise it will be the red RF LED to blink.

8.3 DATA LOGGERS WITH LCD OPTION

According to the data logger model, the LCD display is custom (**L** option) or graphic (**G** option) type. The display shows all quantities measured and calculated by the data logger along with the following RF quantities:

- **RSSI** (*Received Signal Strength Indication*): received signal power;
- **PER** (*Packet Error Rate*): percentage of transmission errors;
- **RF Hops**: 1=direct transmission between data logger and base unit, 2= a repeater added between data logger and base unit, 3=two repeaters added, etc.

The indications of connection status, logging (in progress/deactivated), and battery charge level are displayed.

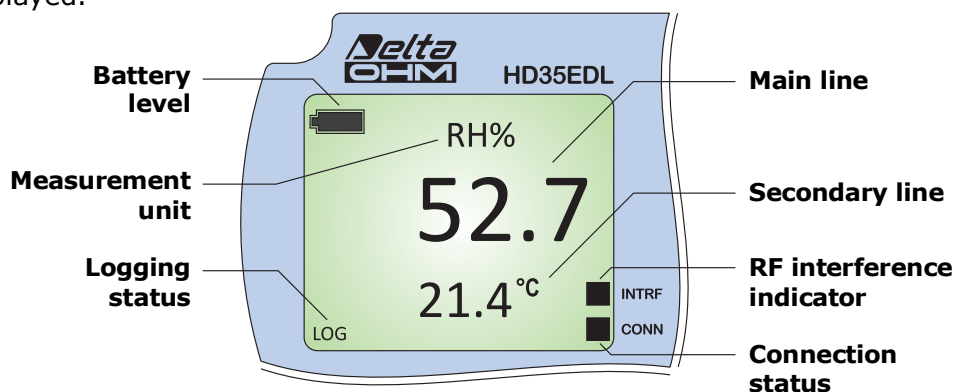

Fig. 8.3.1: custom LCD

In models with custom LCD that measure several quantities, the temperature is displayed in the secondary line, except when a RF quantity appears in the main line; in that case the secondary line shows the number of RF hops.

Models with graphic LCD allow the simultaneous display of 3 measurements in the secondary lines. The graphic display shows in addition the RF signal level and date & time.

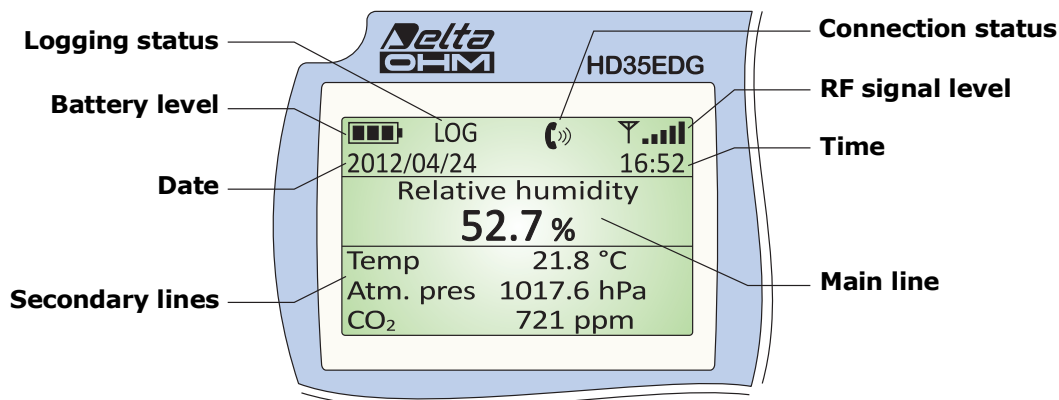

Fig. 8.3.2: graphic LCD

Use the ▲ key to scroll the measured or calculated quantities on the display.

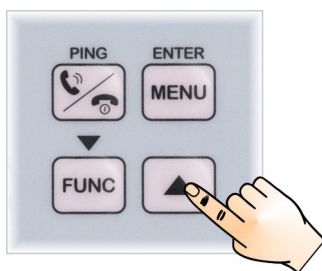

Fig. 8.3.3: selecting the quantities to be displayed

Below please find the indications corresponding to the various quantities in the two types of LCD.

TAB. 8.3.1: indication of quantities on display

Quantity	Custom LCD	Graphic LCD	
		Main line	Secondary line
Temperature (*)	°C or °F stable	Temperature	Temp
Relative humidity	% RH	Relative humidity	RH
Dew point	Td alternated to °C or °F	Dew point	Dew point
Partial vapour pressure	PVP alternated to m.u. (**)	Partial vapor pressure	PVP
Mixing ratio	G/kg	Mixing ratio	Mix ratio
Absolute humidity	G/m ³	Absolute humidity	Abs hum.
Wet bulb temperature	Tw alternated to °C or °F	Wet point	Wet point
Atmospheric pressure	PRES alternated to m.u. (**)	Atmospheric pressure	Atm. Pres
Differential pressure	PRES alternated to m.u. (**)	--	--
Carbon monoxide	--	Carbon monoxide	CO
Carbon dioxide	--	Carbon dioxide	CO ₂
Illuminance	LUX	--	--
UVA irradiance	mW/m ²	--	--
Proportion of UV present	µW/lm	--	--
RF signal power	RSSI alternated to dBm	Received signal strength	RSSI
Percentage of RF errors	PER %	Packet error rate	PER
RF hops	HOP	Number RF hops	RF Hops

(*) In models with more than one temperature channels, the display shows also the number of channel the shown value refers to.

(**) m.u. = unit of measurement

Different measurement units can be set for certain quantities. The setting can be done through the HD35AP-S software (see the software instructions) or by accessing the configuration menu with the front keyboard (see paragraph *The menu in LCD data loggers* on page 42).

8.3.1 Maximum, minimum and average of the measurements

To display the maximum value (**MAX**), the minimum value (**MIN**) and the average (**AVG**) of the acquired values, press the **FUNC** key until the desired function is shown on the display.

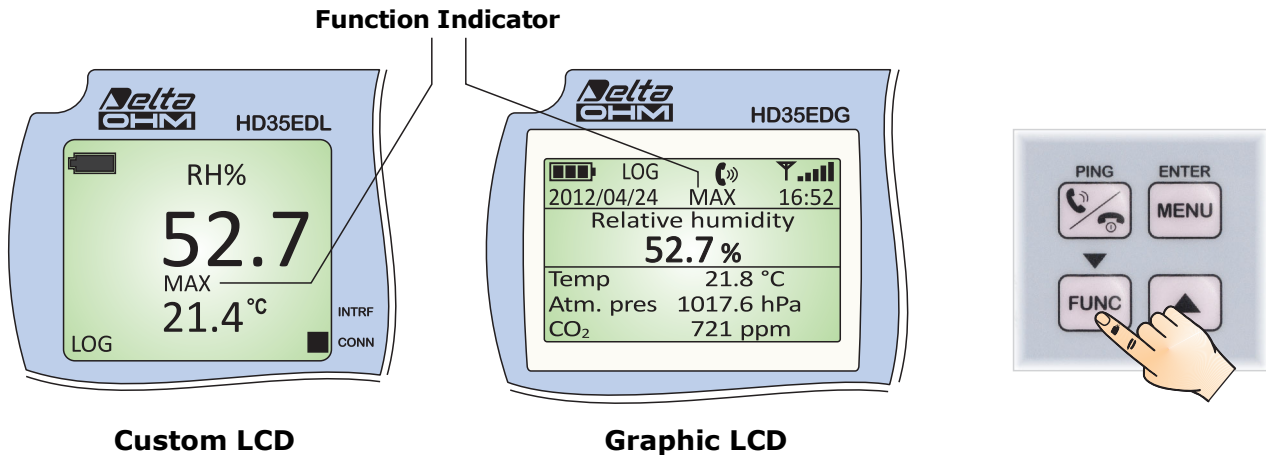

Fig. 8.3.1: selecting a function

To reinitialize the function value and start a new measuring session, press the **FUNC** key until you read *FUNC CLR* (custom LCD) or *Function clear* (graphic LCD), use the arrow keys to select yes and confirm with **ENTER**.

8.4 THE MENU IN LCD DATA LOGGERS

The menu allows displaying the data logger information and changing operation parameters. The menu is structured in levels, with main categories and submenus.

To access the menu you need to enter the **user password** (configurable through the appropriate menu item) or the **administrator password** (supplied with the system and not editable). Entering the user password makes some settings not changeable.

The instrument exits automatically the menu if no key is pressed for 3 minutes. After exiting the menu, the password remains active for a few minutes, during which you may enter the menu again without re-entering the password. It is possible to exit the menu by disabling immediately the password by performing a password level reset in the *Password* menu.

8.4.1 The menu in data loggers with graphic LCD

To access a menu parameter proceed as follows:

1. Press **MENU**.
2. Press ▼ to select the password field.

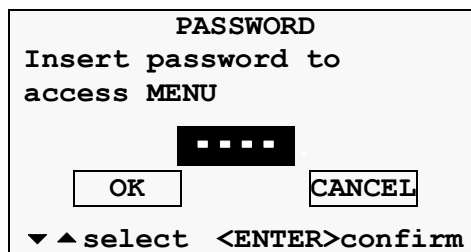

3. Press **ENTER**, the first digit of the password will blink.
4. Use ▼/▲ keys to set the first digit and confirm with **ENTER**, the second digit of the password will blink. Set all the password digits in the same way.
5. Press ▼ to select the option **OK** and confirm with **ENTER**.
6. Use ▼/▲ keys to select a main category of the menu and confirm with **ENTER**.
7. If the selected main category has a submenu, select the desired item using ▼/▲ and con-

firm with **ENTER**.

To exit the main menu or a submenu, select the item EXIT (last menu item).

Changing a parameter

After selecting the desired parameter, it can be changed, if allowed, in the following way:

1. Use ▼/▲ keys to highlight the current setting of the parameter.

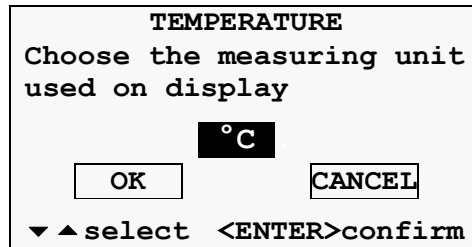

2. Press **ENTER**, the field will start blinking.
3. Use ▼/▲ keys to select the desired setting and confirm with **ENTER**. If you are setting a numeric value, you can move faster by keeping ▼ or ▲ keys depressed.
4. Press ▼ to select the option and confirm with **ENTER**. The instrument closes the parameter window and returns to the previous menu level.

To exit a parameter window without changes, select and confirm with **ENTER**.

If only the option is available in the parameter window, it means that it is not allowed to change the parameter setting.

Menu structure

The complete structure of the main window with the relevant submenus is shown below. According to the data logger model, some items could not be available if not significant for that particular model.

1) Information

It lists the general information of the instrument: model, serial number, RF address, user code, firmware version, calibration date, etc.

2) Display configuration

- 1) **Measures ordering**: changes the order for the display of the measurement quantities on the screen. To move a quantity, select it in the displayed list, press ENTER, move the quantity to the desired position and confirm with ENTER.
- 2) **Reset measures order**: choice of the default or user-defined viewing sequence.
- 3) **Exit**: returns to main menu.

3) RF Parameters

- 1) **Network Address**: network address (not RF) of the data logger. It is used to address the data logger in a Modbus network. Read-only parameter if the instrument is connected to a base unit.
- 2) **RF Channel**: used channel of the RF transmission band. Read-only parameter if the instrument is connected to a base unit.
- 3) **RF Frequency**: used RF transmission band. Only in the ...**U** models, by entering the menu with administrator password it is possible to choose the initial frequency of the RF band among 902, 915 and 921 MHz (the final frequency is always 928 MHz).
- 4) **Max number RF Hops**: maximum number of RF hops from the data logger to the base unit (equal to the number of interposed repeaters plus 1). Read-only parameter if the instrument is connected to the base unit.

- 5) **RF offline**: enables or disables the RF stage of the data logger. Activation or deactivation of the RF stage can be performed also through the connection button.
- 6) **Exit**: returns to the main menu.

4) Ch x settings (x=1, 2, 3) – Only available in the models with configurable inputs

- 1) **Ch x info**: lists all the general information of the input channel Ch x of the instrument: name of measurement, probe type, resolution. The correspondence between the input signal value and the physical quantity value is also indicated for mA, mV, V, Potentiometer and Counter inputs associated with a physical quantity.
- 2) **Ch x configuration**: sets the type of input among the available inputs (see paragraph 8.5.1 on page 51 for setting modes). The input type can be set only with the administrator password.
- 3) **Ch x zero setting**: sets the current measurement value as zero value. Only available for mA, mV, V and Potentiometer inputs associated with a physical quantity.
- 4) **Ch x down threshold**: lower alarm threshold of channel x.
- 5) **Ch x up threshold**: higher alarm threshold of channel x.
- 6) **Ch x reset counter**: zeroes the number of counts. The item is available only if the channel is configured as counter.
- 7) **Exit**: returns to the main menu.

5) Alarm thresholds or Alarm configuration

- 1) **Quantity 1 down threshold**: lower alarm threshold of quantity 1. The type of quantity depends on the data logger model.
- 2) **Quantity 1 up threshold**: higher alarm threshold of quantity 1. The type of quantity depends on the data logger model.
- 3) ...
- 4) **Quantity n down threshold**: lower alarm threshold of quantity n. The type of quantity depends on the data logger model.
- 5) **Quantity n up threshold**: higher alarm threshold of quantity n. The type of quantity depends on the data logger model.
- 6) **Thres. buzzer alarm**: activates or deactivates the buzzer when measurement thresholds are exceeded.
- 7) **Exit**: returns to the main menu.

Note: in the models with configurable inputs, the items down threshold and up threshold of quantities are not available in this submenu, but are included in the menus for the setting of channels Ch 1, Ch 2 and Ch 3.

6) Measure hysteresis

- 1) **Quantity 1 hysteresis**: hysteresis of the alarm thresholds of quantity 1. The type of quantity depends on the data logger model.
- 2) ...
- 3) **Quantity n hysteresis**: hysteresis of the alarm thresholds of quantity n. The type of quantity depends on the data logger model.
- 4) **Exit**: returns to the main menu.

The width of the hysteresis is a percentage (0 ... 100%) of the difference between the two alarm thresholds.

For example, if Hysteresis=2%, Lower threshold=10 °C and Upper threshold=60 °C, the hysteresis is $(60-10) \times 2 / 100 = 1$ °C:

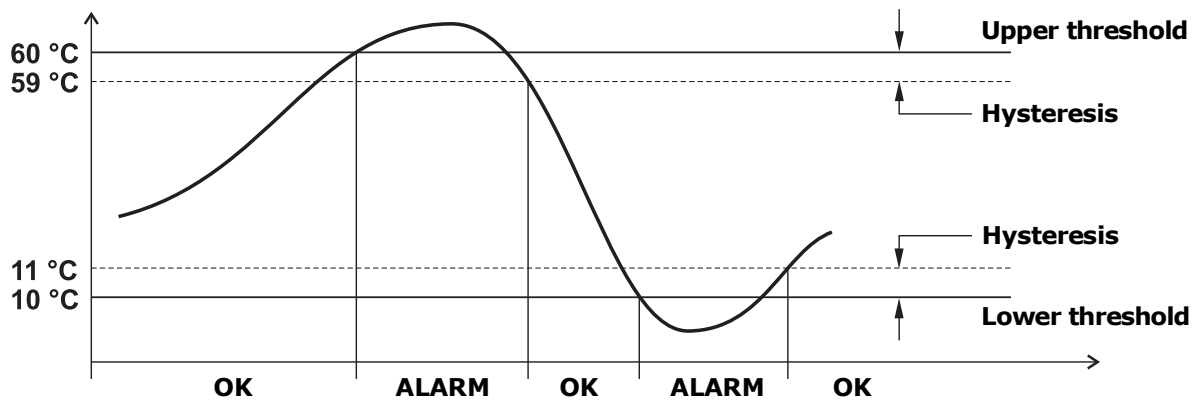

Fig. 8.4.1: hysteresis of the alarm thresholds

7) Alarm time delay

- 1) **Quantity 1 alarm delay:** delay for alarm activation of quantity 1. The type of quantity depends on the data logger model.
- 2) ...
- 3) **Quantity n alarm delay:** delay for alarm activation of quantity n. The type of quantity depends on the data logger model.
- 4) **Exit:** returns to the main menu.

If the measured value drops below the lower threshold or exceeds the upper threshold, the alarm is generated after the time set. The alarm is generated immediately if 0 is set. If the alarm condition ends before the delay time is elapsed, the alarm is not generated.

8) Unit measures

- 1) **Quantity 1:** measurement unit of quantity 1. The type of quantity depends on the data logger model.
- 2) ...
- 3) **Quantity n:** measurement unit of quantity n. The type of quantity depends on the data logger model.
- 4) **Exit:** returns to the main menu.

Note: in the HD35EDH model, only the temperature measurement unit is available. Measurement units for the other quantities are configurable in the menus for the setting of channels Ch 1, Ch 2 e Ch 3.

Note: the unit of measurement is changed only on the LCD; the data are always sent in the unit of measurement set in the base unit.

9) Logging

- 1) **Start/stop log:** enables or disables logging.
- 2) **Logging mode:** choice between cyclical management (the new data overwrite the old ones when the memory is full) or non-cyclical management (logging stops when the memory is full) of the data logger memory.
- 3) **Log/RF Tx interval:** choice of logging and RF transmission interval (the two intervals coincide). If it is higher than the measuring interval, the average of the measurements acquired during the interval will be stored.
- 4) **Measure interval:** choice of the measurements acquisition interval. It is forced to the value *RF log/Tx interval* if a higher value is set.
- 5) **Log erase:** deletes all stored measurements from the data logger memory.
- 6) **Exit:** returns to the main menu.

10) Clock

- 1) **Clock Configuration**: date/time of data logger. Read-only parameter if the instrument is connected to a base unit.
- 2) **Exit**: returns to the main menu.

11) Password

- 1) **Reset password level**: exits menu disabling immediately the password (the password will not remain active for some minutes like it usually happens when exiting a menu: you will have to re-enter the password even if you access the menu at once).
- 2) **User password config.**: sets the user level password.
- 3) **Exit**: returns to the main menu.

12) CO₂ auto calibration – *Only available in models with integrated CO₂ sensor*

- 1) **Start/stop auto-calib.**: enables or disables CO₂ auto-calibration.
- 2) **Auto-calib. period**: time interval between two consecutive auto-calibrations.
- 3) **Auto-cal. 1st period**: time interval after which the first auto-calibration will be performed after activation.
- 4) **Background CO₂ value**: CO₂ reference value for auto-calibration.
- 5) **Auto-cal. max change**: maximum offset that can be applied to the measurement by the auto-calibration procedure.
- 6) **Exit**: returns to the main menu.

13) Calibration – *Only available with administrator password*

- 1) **CO 0 ppm calibration**
- 2) **CO sensitivity calib.**: sets the sensitivity of the CO sensor, when the sensor is replaced.
- 3) **CO₂ calibration**
- 4) **Calibration Type**: choice between user calibration and factory calibration.
- 5) **Exit**: returns to the main menu.

Note: relative humidity calibration is only available in models with R.H. sensor that can be calibrated by user: HD35ED...TC and HD35ED...TV models. This sensor is not used in models with graphic display; consequently the R.H. calibration is not displayed in the menu.

14) Language

- 1) **Language config.**: choice of the language to be used for the display.
- 2) **Exit**: returns to the main menu.

15) Exit

Returns to the measurement mode.

8.4.2 The menu in data loggers with custom LCD

To access a menu parameter proceed as follows:

1. Press **MENU**, the first digit of the password will blink.
2. Using $\blacktriangledown/\blacktriangle$ keys, set the first digit and confirm with **ENTER**, the second digit of the password will blink. Set all the password digits in the same way.
3. Using $\blacktriangledown/\blacktriangle$ keys, select a main category in the menu and confirm with **ENTER**. Menu items appear one at a time in the upper part of the display; the lower part of the display shows the position of the item in the menu and the total number of items in the menu (for ex. "8 - 10" means the eighth item in a menu of 10 items).

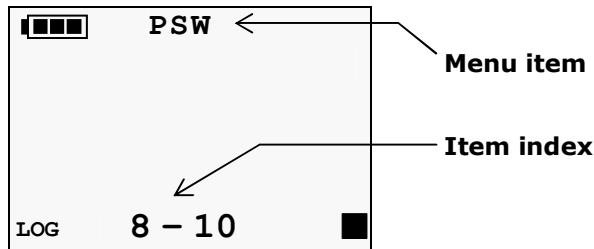

4. If the selected main category has a submenu, select the desired item using $\blacktriangledown/\blacktriangle$ keys and confirm with **ENTER**. Scrolling the submenus displays also the parameter current setting.
5. To change the selected parameter, if allowed, use $\blacktriangledown/\blacktriangle$ keys to select the desired setting and confirm with **ENTER**. If you are setting a numeric value, you can fast forward by keeping \blacktriangledown or \blacktriangle keys depressed.

To exit the main menu or a sub menu, select EXIT item (last menu item).

If it is not allowed to change a parameter, the notice N/A (Not Available) will appear when pressing ENTER to select it.

Menu structure

The complete structure of the main menu with the relevant submenus is shown below. According to the data logger model, some items could be not available if not significant for that particular model.

1) DEV_INFO (information)

It lists the general information of the instrument: model, serial number, RF address, user code, firmware version, calibration date, etc. Information is shown in the upper part of the display.

2) DISP_MENU (display configuration)

- 1) **DISP_LOOP_FOR_MEAS**: enables or disables the cyclical display of the measured quantities. Select *YES* to activate the cyclical display. The derived humidity quantities are not cyclically displayed. The menu item is available only if the data logger measures two or more quantities, in addition to temperature.
- 2) **EXIT**: returns to the main menu.

3) RF_MENU (RF parameters)

- 1) **NET_ADDR**: network address (not RF) of the data logger. It is used to address the data logger in a Modbus network. Read-only parameter if the instrument is connected to a base unit.
- 2) **RF_CHAN**: used channel of RF transmission band. Read-only parameter if the instrument is connected to a base unit.
- 3) **RF_FREQ_MHZ**: used RF transmission band. Only in the ...**U** models, by entering the menu with administrator password it is possible to choose the initial frequency of the RF band among 902, 915 and 921 MHz (the final frequency is always 928 MHz).
- 4) **MAX_NUM_RF_HOPS**: RF hops maximum number from data logger to base unit

(equal to the number of interposed repeaters plus 1). Read-only parameter if the instrument is connected to a base unit.

- 5) **RF_OFF_LINE**: enables or disables the RF stage of the data logger. Select *NO* to activate the RF stage. Activation or deactivation of the RF stage can be done also through the connection button.
- 6) **EXIT**: returns to the main menu.

4) THLD_MENU (alarm thresholds)

- 1) **Quantity 1_DOWN_THLD**: lower alarm threshold of quantity 1. The type of quantity depends on the data logger model.
- 2) **Quantity 1_UP_THLD**: higher alarm threshold of quantity 1. The type of quantity depends on the data logger model.
- 3) ...
- 4) **Quantity n_DOWN_THLD**: lower alarm threshold of quantity n. The type of quantity depends on the data logger model.
- 5) **Quantity n_UP_THLD**: higher alarm threshold of quantity n. The type of quantity depends on the data logger model.
- 6) **THLD_ALARM**: enables or disables the buzzer when measurement thresholds are exceeded.
- 7) **EXIT**: returns to the main menu.

5) HYST_MENU (hysteresis of the alarm thresholds)

- 1) **Quantity 1_HYST%**: hysteresis of the alarm thresholds of quantity 1. The type of quantity depends on the data logger model.
- 2) ...
- 3) **Quantity n_HYST%**: hysteresis of the alarm thresholds of quantity n. The type of quantity depends on the data logger model.
- 4) **EXIT**: returns to the main menu.

The width of the hysteresis is a percentage (0 ... 100%) of the difference between the two alarm thresholds.

For example, if Hysteresis=2%, Lower threshold=10 °C and Upper threshold=60 °C, the hysteresis is $(60-10) \times 2 / 100 = 1$ °C:

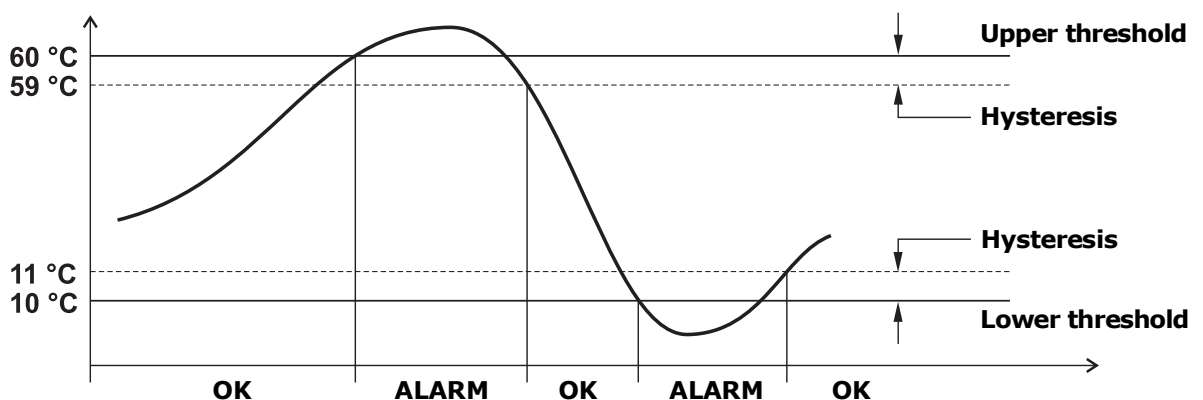

Fig. 8.4.2: hysteresis of the alarm thresholds

6) **ALRM_DELY_MENU** (delay for alarm activation)

- 1) **Quantity 1_ALRM_DELY**: delay for alarm activation of quantity 1. The type of quantity depends on the data logger model.
- 2) ...
- 3) **Quantity n_ALRM_DELY**: delay for alarm activation of quantity n. The type of quantity depends on the data logger model.
- 4) **EXIT**: returns to the main menu.

If the measured value drops below the lower threshold or exceeds the upper threshold, the alarm is generated after the time set. The alarm is generated immediately if 0 is set. If the alarm condition ends before the delay time is elapsed, the alarm is not generated.

7) **MEAS_UNIT_MENU** (measurement unit)

- 1) **Quantity 1_UNIT_MEAS**: measurement unit of quantity 1. The type of quantity depends on the data logger model.
- 2) ...
- 3) **Quantity n_UNIT_MEAS**: measurement unit of quantity n. The type of quantity depends on the data logger model.
- 4) **EXIT**: returns to the main menu.

Note: the unit of measurement is changed only on the LCD; the data are always sent in the unit of measurement set in the base unit.

8) **LOG_MENU** (logging)

- 1) **LOG_STAT**: enables or disables the logging.
- 2) **LOG_CYCL**: choice between cyclical management (the new data overwrite the old ones when the memory is full) or non-cyclical management (logging stops when the memory is full) of the data logger memory. Select *YES* for the cyclical management.
- 3) **LOG/RF_TIME**: choice of logging and RF transmission interval (the two intervals coincide). If it is higher than the measuring interval, the average of the measurements acquired during the interval will be stored.
- 4) **MEAS_TIME**: choice of the measurements acquisition interval. It is forced to the value *Log/RF_TIME* if a higher value is set.
- 5) **LOG_DEL**: deletes all stored measurements from the data logger memory. Select *YES* to delete the memory.
- 6) **EXIT**: returns to the main menu.

9) **CLK_MENU** (clock)

- 1) **YEAR**: year. Read-only parameter if the instrument is connected to a base unit.
- 2) **MON**: month. Read-only parameter if the instrument is connected to a base unit.
- 3) **DAY**: day. Read-only parameter if the instrument is connected to a base unit.
- 4) **HOURL**: hour. Read-only parameter if the instrument is connected to a base unit.
- 5) **MIN**: minutes. Read-only parameter if the instrument is connected to a base unit.
- 6) **EXIT**: returns to the main menu.

10) **PSW_MENU** (password)

- 1) **RST_PSW_LVL**: exits the menu and deactivates immediately the password (the password will not remain active for some minutes as it normally happens when exiting the menu: you will need to re-enter the password even if you re-access immediately the menu).
- 2) **SET_NEW_PSW**: sets user-level password.
- 3) **EXIT**: returns to the main menu.

11) CAL_MENU (calibration) – *Only available with administrator password*

- 1) **RH_75%_CAL**: relative humidity sensor calibration at 75%RH. The item appears only in models with R.H. sensor that can be calibrated by user (HD35ED...TC and HD35ED...TV).
- 2) **RH_33%_CAL**: relative humidity sensor calibration at 33%RH. The item appears only in models with R.H. sensor that can be calibrated by user (HD35ED...TC and HD35ED...TV).
- 3) **HOSE_LEN_m**: length (in meters) of the tube connecting the input of the instrument to the pressure measuring point (enter the length of only one of the two tubes). The item appears only in HD35ED...4r5TV models.
- 4) **HOSE_DIAM_mm**: diameter (in mm) of the tube connecting the input of the instrument to the pressure measuring point (default 6 mm). The item appears only in HD35ED...4r5TV models.
- 5) **ABS_PRES_mbar**: absolute pressure (in mbar) of the air in the connecting tube. The item appears only in HD35ED...4r5TV models.
- 6) **DIFF_PRES_0 Pa_CAL**: calibration of differential pressure to zero. The item appears only in HD35ED...4r...TV models.
- 7) **LGHT_SENS_PA_LUX**: illuminance sensor sensitivity in pA/lux. The item appears only in HD35ED...I...TCV models.
- 8) **UVA_SENS_nA_W/m²**: UVA irradiance sensor sensitivity in nA/Wm⁻². The item appears only in HD35ED...IU...TCV models.
- 9) **CAL_TYPE**: choice between user calibration (*USER*) or factory calibration (*FACT*).
- 10) **EXIT**: returns to the main menu.

12) EXIT

Returns to measurement mode.

8.5 CONNECTING THE MODEL WITH TERMINAL HEADER INPUTS

HD35ED[G]H model has three terminal header inputs. Each input can be configured as a Pt100/Pt1000, thermocouple, 0/4...20 mA (shunt resistance inside), 0...50 mV, 0...1 V or potentiometric input. Only input 3 can be also configured as pulse counter (count of voltage-free contact switchings).

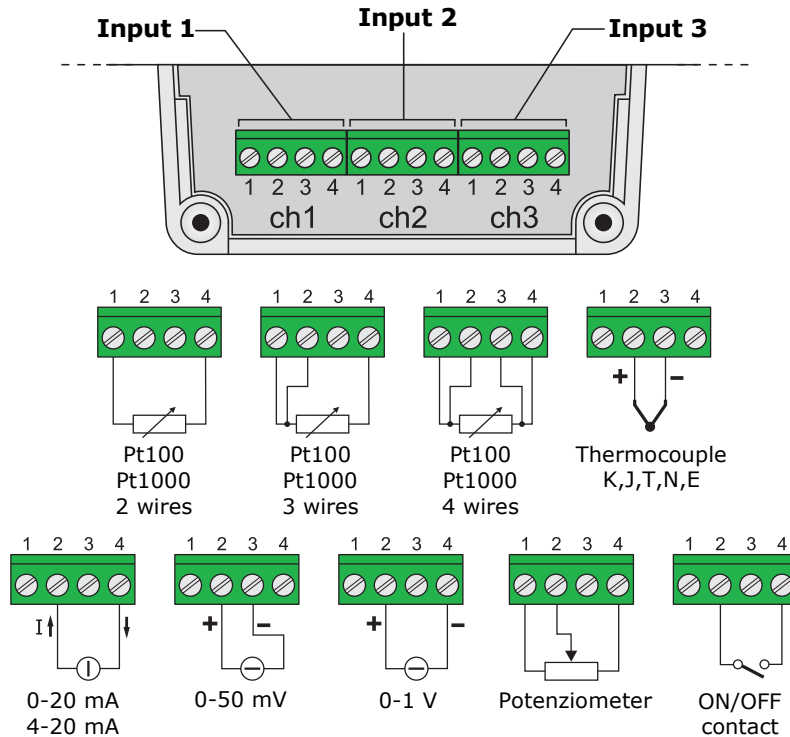

Fig. 8.5.1: sensor connection in HD35EDH model

If a channel is configured as current input, insert the 50 Ω shunt resistance closing the jumper placed on the terminals of the relevant channel. In all the other configurations, leave the jumper open.

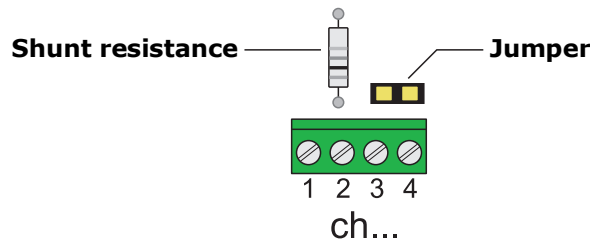

Fig. 8.5.2: shunt resistance for current input

The current input accepts any value in the range 0 to 20 mA.

8.5.1 INPUTS CONFIGURATION

Configuration of inputs can be implemented through the HD35AP-S software (see software instructions) or, if the data logger is equipped with a display, through the front keyboard.

To configure the input channel ch x (x=1,2,3 is the number of the input) through the keyboard, access the menu and select the item *Ch x settings* \Rightarrow *ch x configuration*. Set the type of input among those available:

- Pt100 2-wire, Pt100 3-wire, Pt100 4-wire, Pt1000 2-wire, Pt1000 3-wire, Pt1000 4-wire,
- TC-K, TC-J, TC-T, TC-N, TC-E,
- 0-1V, 0-50mV, 4-20mA, Potentiometer, Counter, Frequency,
- 0-1V Mapped, 0-50mV Mapped, 4-20mA Mapped, Mapped Potent., Mapped Count., Mapped Freq.

The input types *4-20mA* and *4-20mA Mapped* also work with 0-20 mA signals. The input types *Counter* and *Frequency* are only in channel Ch 3.

Set *NO MEASURE* if the channel is not used.

The indication *Mapped* means that a linear correspondence between input values (in mA, mV, V, Ω or counts) and the values of a physical quantity will be associated to the channel. For example, if *4-20mA* is selected, the data logger stores the input value in mA; if *4-20mA Mapped* is selected, the data logger doesn't store the input value in mA but the corresponding value of the physical quantity associated to the input.

By selecting a Mapped-type configuration, the guided procedure for the association between the input values (in mA, mV, V, Ω or counts) and the values of the corresponding physical quantity is started. The procedure is illustrated below:

1. After confirming the selection of a Mapped input, the procedure start message is displayed, press **ENTER** to continue.
2. Select the measurement unit of the physical quantity among those proposed by the instrument. If the desired measurement unit is not in the list, select *NOT DEF* (not defined). Select the option and confirm with **ENTER** to continue.
3. Select the measurement resolution of the physical quantity among those proposed by the instrument. Select the option and confirm with **ENTER** to continue.
4. A message will be displayed reminding that the two coordinates of the linear relation between input and physical quantity will be now required:
 - x1=input value (in mA, mV, V, Ω or counts) in the first point,
 - y1=value of the physical quantity corresponding to the input value x1,
 - x2=input value (in mA, mV, V, Ω or counts) in the second point,
 - y2=value of the physical quantity corresponding to the input value x2,

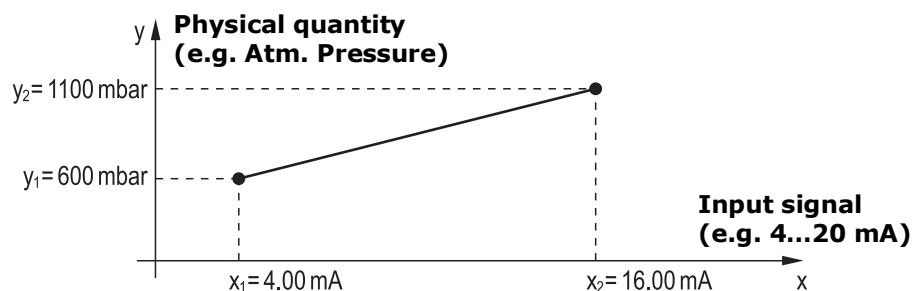

Fig. 8.5.3: association of a physical quantity to the input signal

press **ENTER** to continue.

5. Select the input value x1 for the first point (e.g. 4.00 mA). Select the option and confirm with **ENTER** to continue.
6. Select the physical quantity value y1 for the first point (e.g. 600 mbar). Select the option and confirm with **ENTER** to continue.
7. Select the input value x2 for the second point (e.g. 20.00 mA). Select the option and confirm with **ENTER** to continue.
8. Select the physical quantity value y2 for the second point (e.g. 1100 mbar). Select the option and confirm with **ENTER** to continue.
9. The message requesting confirmation of the configuration storage is displayed, press **YES** to save the settings and terminate the procedure.

The procedure can be stopped at any moment by selecting the option and confirming with **ENTER**.

A user name can be associated to each measurement channel to remind the type of physical quantity detected. The user name can be set only through the HD35AP-S software.

8.6 CALIBRATION

Instruments and sensors are all factory-calibrated and do not normally require further interventions of the user. Anyway, a new sensor calibration can be performed for:

- CO at zero ppm,
- CO₂ at any reference value within the measurement range,
- R.H. at 75% and 33% (only HD35ED...TC and HD35ED...TV models),
- Differential pressure at zero.

R.H. calibration is not available for HD35ED...TVI models and for models with internal sensors (HD35ED[G]14bNAB and HD35ED[G]1NAB).

No calibration is scheduled for temperature sensors.

For a correct calibration of the probes, it is crucial to know and respect the physical phenomena which underlie measurements: for this reason, it is recommended to thoroughly follow the following instructions and to perform new calibrations only if in possession of adequate technical knowledge and instruments.

To access calibration, the data logger must have the user-calibration option set:

- In models with graphic LCD, select the menu item *Calibration* ⇒ *Calibration Type* and set the *User* option.
- In models with custom LCD, select the menu item *CAL_MENU* ⇒ *CAL_TYPE* and set the *User* option.

The calibration procedure deletes the data of the previous user calibration. In case of failed procedure, you can always return the instrument to factory calibration by selecting:

- in models with graphic LCD, the menu item *Calibration* ⇒ *Calibration Type* and setting the *Factory* option;
- in models with custom LCD, the menu item *CAL_MENU* ⇒ *CAL_TYPE* and setting the *FACT* (factory) option.

Calibration can be performed with HD35AP-S software (see software instructions) or, if the data logger has a display, through the front keyboard.

8.6.1 CO SENSOR CALIBRATION

This calibration is available in HD35ED[G]14bNAB and HD35ED[G]1NAB models.

The **zero** of the CO sensor can be calibrated in clean air (in outdoor environment CO concentration is less than 0.1ppm) or with the aid of nitrogen bottles (cod. MINICAN.12A).

To use the nitrogen bottle, unbolt the two screws fixing the sensor protection grid, remove the grid and connect the tube with the rubber sleeve coming from the bottle to the CO sensor head. Supply the gas by adjusting the bottle flow meter so as to obtain a constant flow ranging within 0.1 and 0.2 l/min.

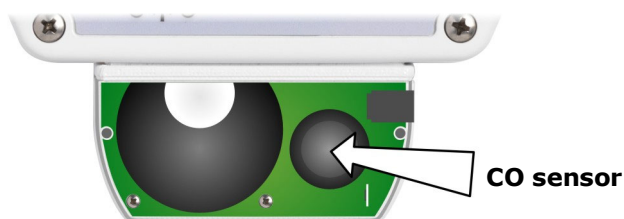
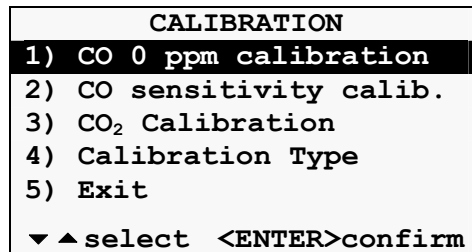

Fig. 8.6.1: CO sensor position

Calibration procedure:

1. Place the instrument in clean air or connect the nitrogen bottle as indicated above.
2. Wait for at least 15 minutes for the measurement to stabilize, with the instrument on.
3. Access the menu with the administrator password and select the item *Calibration* ⇒ *CO 0 ppm calibration*. Press **ENTER** to confirm.



4. Select the option and confirm with **ENTER**: the instrument stores the calibration and returns to the calibration submenu.

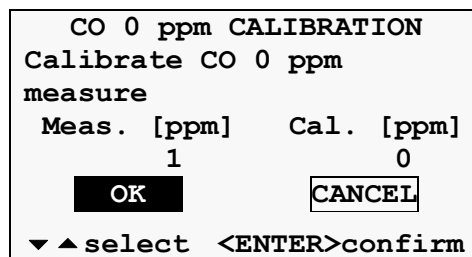

5. If the nitrogen bottle was used, close the bottle tap, remove the CO sensor sleeve and place again the protection grid by fixing it with the two screws.

8.6.2 REPLACING THE CO SENSOR

The CO sensor has an expected average life of over 5 years of use in normal conditions. Where it becomes necessary to replace the CO sensor, proceed as shown below.

Replacement procedure:

1. Unscrew the two front screws on the housing, remove the back cover and disconnect the battery.
2. Unscrew the two screws fixing the protection grid of the sensors, remove the grid and extract the exhaust CO sensor (see fig. 8.6.1 for sensor position).
3. Take the new CO sensor and note the number marked on the edge of the new sensor indicating its sensitivity in nA/ppm.

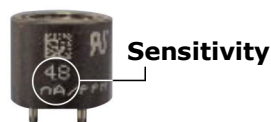
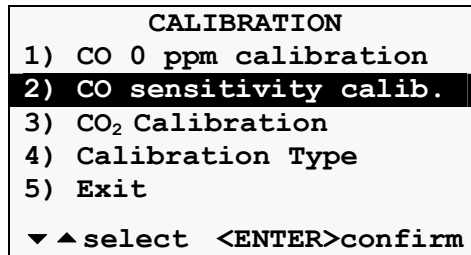
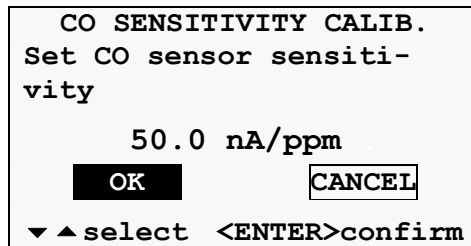

Fig. 8.6.2: CO sensor sensitivity

4. Insert the new sensor electrodes in the contacts.
5. Apply again the protection grid by fixing it with the two screws.
6. Reconnect the battery and close again the housing by fixing the 4 front screws.
7. Access the menu with the administrator password and select the *Calibration* ⇒ *CO sensitivity calib.* item. Press **ENTER** to confirm.



8. Enter the sensitivity value, select the option and confirm with **ENTER**: the instrument stores the value and returns to the calibration submenu.



9. Wait for at least 5 minutes after starting the instrument before detecting the measurement, so as to let the measurement become stable. If necessary, perform zero calibration of the new CO sensor.

8.6.3 CO₂ SENSOR CALIBRATION

This calibration is available in HD35ED[G]14bNAB and HD35ED[G]1NAB models.

The CO₂ sensor can be calibrated to any reference value within the measurement range.

Calibration procedure:

1. Place the instrument in an environment with known CO₂ concentration (for ex. in clean air).
2. Wait for at least 15 minutes for the measurement to become stable, with the instrument on.
3. Access the menu with the administrator password and select the item *Calibration* ⇒ *CO₂ calibration*. Press **ENTER** to confirm.

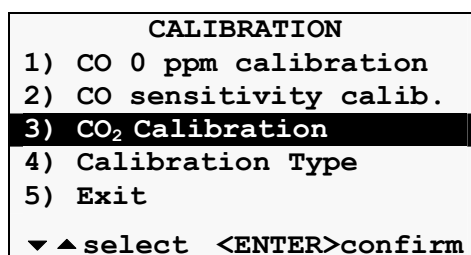

4. The value measured by the instrument appears on the left, and the calibration point on the right. The instrument initially proposes the same measurement value as calibration point.
5. Enter the calibration value, select the option and confirm with **ENTER**.

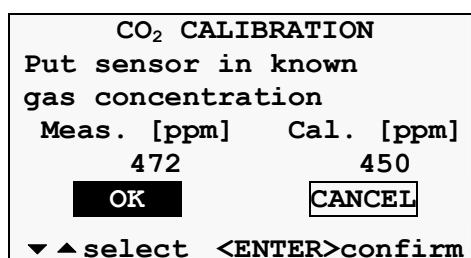

- The instrument tests the measurement stability. Wait for a few minutes for measurement completion. In the meantime, don't stay too close to the instrument to avoid altering the measurement.

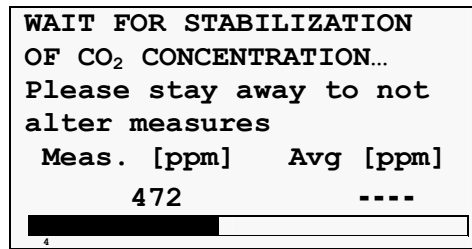

- At the end, a message is shown indicating the calibration success or failure. Press any key to return to the calibration submenu.

If a message appears declaring that calibration has failed, it means that the value measured by the instrument during the procedure differs too much from the set reference value. In that case repeat calibration checking the CO₂ reference value in the environment and making sure to operate in a stable environment.

8.6.4 CO₂ SENSOR AUTOCALIBRATION

In HD35ED[G]14bNAB and HD35ED[G]1NAB models, the instrument can be set so as CO₂ calibration is automatically performed at predetermined intervals.

In order for auto calibration to be effective, the CO₂ concentration in the environment where the instrument is installed must assume a known value (referred to as environment **background value**). For example, we can have that an instrument installed inside a public place performs a weekly auto calibration when people are not present and CO₂ concentration is close to the outdoor air value (if there is an adequate air change).

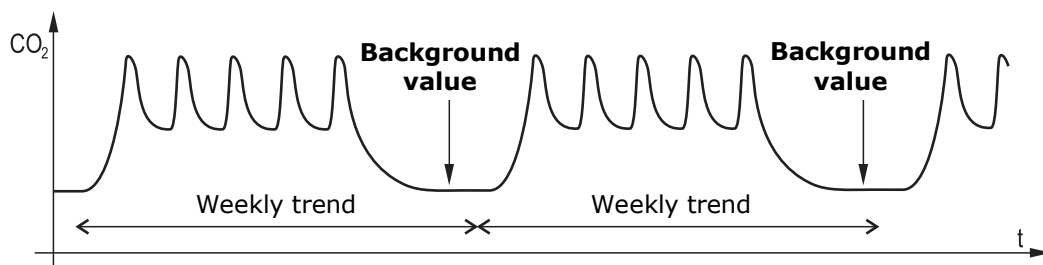

Fig. 8.6.3: example of background value for CO₂ auto calibration

The offset applied to the measurement by the auto calibration procedure can be limited to a maximum value, so as to avoid erroneous calibrations when the measured value differs too much from the estimated background value. The auto calibration procedure acts therefore in the following way:

- If the difference between the measured value and the background value is lower than the maximum offset, an offset is applied to the measurement so that the measured value coincides with the background value.
- If the difference between the measured value and the background value is higher than the maximum offset, only the maximum offset is added or subtracted so as to approach the background value.

To set the auto calibration interval and the maximum offset and to activate auto calibration see the menu item *CO₂ autocalibration* on page 46.

8.6.5 CALIBRATING THE RELATIVE HUMIDITY SENSOR

In HD35ED...TC and HD35ED...TV models, the sensor can be calibrated in the two points 75%RH and 33%RH.

Note: the R.H. sensor can not be calibrated in the ...TVI, HD35ED1NB, HD35EDG1NB, HD35ED1NAB, HD35EDG1NAB, HD35ED14bNAB and HD35EDG14bNAB models.

Before starting the calibration procedure, it's better to **check** if a new calibration is necessary, with the aid of 75.4%RH and 33%RH saturated solutions: a calibration will be performed only if an error of a few humidity points in one of the two calibration points is detected.

The sensor can be calibrated in both points or in one point only.

Preliminary operations before calibration:

Check that the chamber with the saturated saline solutions contains at the same time:

- solid state salt,
- liquid solution or wet salt, in particular for the 75%RH solution.

The instrument and the saturated solutions to be used for this operation must be placed in a stable temperature environment for the whole calibration period. Wait for at least a couple of hours with a stable temperature so that the instrument and the saturated solutions reach a thermal balance with the environment before starting the calibration procedure. In order to obtain a good calibration, it is crucial that the probe and the solution have the same temperature. Bear in mind that plastic material is a bad heat conductor.

Calibration should be performed at a temperature ranging within 15 and 30°C.

Calibration procedure:

1. Unscrew the probe protection grid and screw the M12×1 threaded ring.
Avoid any contact of the sensitive element with your hands or other objects or liquids. **If some liquid has formed inside the measuring chamber, dry it with a clean absorbent paper towel.**
2. Unscrew the cap of the saturated solution. Screw the threaded ring with the probe on the saturated solution container and wait for at least 30 minutes.
3. Access the menu with the administrator password and select the item *CAL_MENU*. Press **ENTER** to confirm.
4. Select the item *RH_75%_CAL* to calibrate the point 75%RH or *RH_33%_CAL* to calibrate the point 33%RH. Press **ENTER** to confirm.
5. The blinking value of the saturated solution at the temperature measured by the probe is displayed.

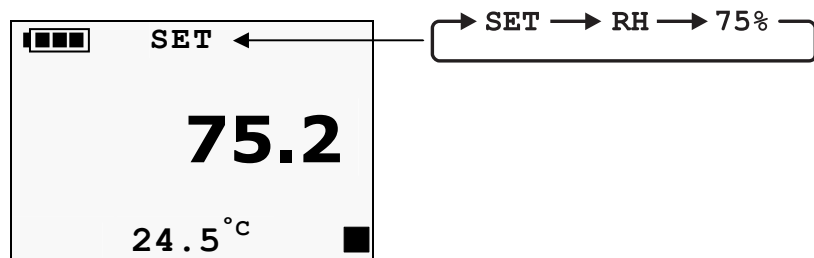

Note: the suggested calibration value is not updated if the measured temperature changes after starting calibration. If necessary, set manually the calibration value to the value of the saturated solution at the measured temperature using ▼/▲ keys (see table 8.6.1 below).

6. Press **ENTER** to confirm the value, the instrument stores the calibration and returns to the calibration submenu.

7. Remove the threaded ring with the probe from the container of the saturated solution and close the container with the solution.
8. To calibrate the second point, repeat the procedure from step 2 to step 7 with the second saturated solution.
9. Unscrew the M12X1 threaded ring from the probe and place again the sensor protection grid.

TAB. 8.6.1: saturated solutions

Temperature (°C)	33%RH Solution	75%RH Solution
15	33.3	75.6
20	33.0	75.4
25	32.7	75.2
30	32.4	75.0

8.6.6 DIFFERENTIAL PRESSURE CALIBRATION

Differential pressure sensors may show a slight difference between the two inputs, consequently the instrument, with an equal pressure applied to the two inputs, doesn't show a zero value. Proceed as follows for the zeroing of the differential value.

Calibration procedure:

1. Leave the instrument pressure input open.
2. Access menu with the administrator password and select the item *CAL_MENU* ⇒ *DIFF_PRES_0 Pa_CAL*. Press **ENTER** to confirm.
3. The zero value blinks on the display.

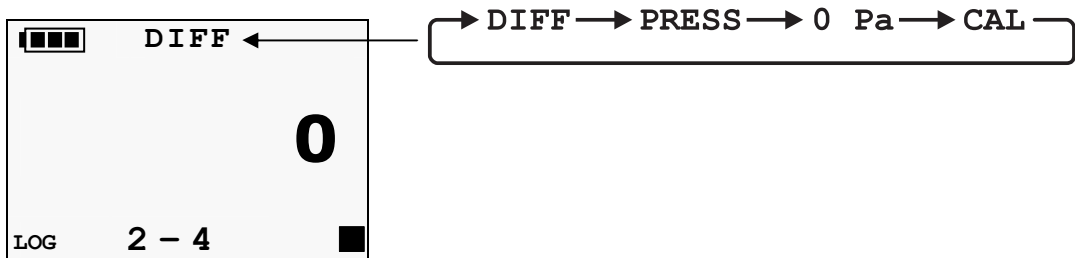

4. Press **ENTER**, the instrument stores the calibration and returns to the calibration submenu.

Note: in the HD35ED...4r5TV models, set the length and the diameter of the connecting tube and the absolute pressure inside the tube (items *HOSE_LEN_m*, *HOSE_DIAM_mm* and *ABS_PRES_mbar* of the calibration menu).

8.6.7 SENSITIVITY OF THE ILLUMINANCE AND/OR UVA IRRADIANCE PROBE

If the illuminance and/or UVA irradiance probe is replaced, you need to set in the data logger the sensitivity of the new probe. Proceed as follows.

1. Access menu with the administrator password and select the item *CAL_MENU* ⇒ *LGHT_SENS_PA_LUX* to set the sensitivity of the illuminance sensor (in pA/lux) or *CAL_MENU* ⇒ *UVA_SENS_nA_W/m²* to set the sensitivity of the UVA irradiance sensor (in nA/Wm⁻²).
2. Press **ENTER**, the current sensitivity value blinks on the display.
3. Set the new value by using the ▼/▲ keys.
4. Press **ENTER**, the instrument returns to the calibration submenu.

8.7 TECHNICAL CHARACTERISTICS OF DATA LOGGERS IN INDOOR USE HOUSING

<i>Transmission frequency</i>	868 MHz, 902-928 MHz or 915.9-929.7 MHz according to the model
<i>Antenna</i>	Internal
<i>Transmission range</i>	In open field: 300 m (E, J)/ 180 m (U) towards base unit (except HD35APD...) and repeaters. 180 m (E, U) towards base unit HD35APD. (could be reduced if obstacles or adverse weather conditions are present)
<i>Display</i>	Optional. Custom or graphic LCD according to the model (see table 8.1.2).
<i>Keyboard</i>	Connection / PING (for testing RF) button. Models with LCD have buttons for the configuration and scrolling of measured values.
<i>LED Indicators</i>	RF communication status. Models without LCD have alarm and battery level LEDs.
<i>Measuring interval</i> ^(*)	1, 2, 5, 10, 15, 30 s / 1, 2, 5, 10, 15, 30, 60 min
<i>Logging and transmission interval</i> ^(*)	1, 2, 5, 10, 15, 30 s / 1, 2, 5, 10, 15, 30, 60 min
<i>Internal memory</i>	Circular management or stop logging if memory is full. The number of storable samples depends on the number of detected quantities (see table 8.7.1).
<i>Alarm</i>	Acoustic by means of the internal buzzer
<i>Power supply</i>	Non rechargeable lithium thionyl chloride (Li-SOCl ₂) internal battery, 3.6 V, AA format, 2-pole Molex 5264 connector. A connector for external power supply (SWD06) is available in models in housing with grid.
<i>Battery life</i> (without repeaters, direct communication with HD35AP...)	1.5 years typical for CO/CO ₂ models (with 2 min measurement and logging intervals) and for ΔP range r5 model (with 30 s measurement and logging intervals); 2 years typical for the other models, with logging interval 30 s and measurement interval 30 s for ΔP ranges r1...r4 models, 10 s for HD35EDH and 5 s for the other models.
<i>Operating temperature and humidity</i>	-20...+70 °C (-10...+70 °C for models with grid) 0...85 %RH non condensing
<i>Dimensions</i>	See dimensional drawings
<i>Connectors for external probes with cable</i>	According to the model, M12 connectors or 3.5 mm pitch input terminals.
<i>Weight</i>	200 g approx. (version with LCD, battery included)
<i>Housing</i>	LURAN® S 777K
<i>Protection Degree</i>	IP 64 (versions with M12 connectors)
<i>Installation</i>	Wall support (supplied) for removable installation or flanges (option) for fixed installation.

(*) Some models that measure several quantities may have a minimum interval exceeding 1 second (see table 8.7.1). Each system data logger can be set with its own measuring and logging interval. The stored value is the average of the measurements acquired during the logging interval.

TAB. 8.7.1: memory capacity of data loggers in indoor use housing

Model	Number of storable samples (**)	Minimum logging interval	Stored quantities (*)
HD35ED 7P/1 TC	68,000	5 s	T
HD35ED 7P/2 TC	52,000	5 s	T
HD35ED 7P/3 TC	42,000	5 s	T
HD35ED N/1 TC	68,000	1 s	T
HD35ED N/2 TC	52,000	1 s	T
HD35ED N/3 TC	42,000	1 s	T
HD35ED N TV	68,000	1 s	T
HD35ED 1 TV	68,000	1 s	RH
HD35ED 1 TVI	68,000	1 s	RH
HD35ED 1N TC	24,000	1 s	T, RH, T _D , T _w , AH, MR, PVP
HD35ED 17P TC	24,000	1 s	T, RH, T _D , T _w , AH, MR, PVP
HD35ED 1N TV	24,000	1 s	T, RH, T _D , T _w , AH, MR, PVP
HD35ED 1N TVI	24,000	1 s	T, RH, T _D , T _w , AH, MR, PVP
HD35ED 1N/2 TC	22,000	1 s	T, RH, T _D , T _w , AH, MR, PVP
HD35ED 1N/2 TCV	22,000	1 s	T, RH, T _D , T _w , AH, MR, PVP
HD35ED 14bN TC	22,000	2 s	T, RH, T _D , T _w , AH, MR, PVP, P _{ATM}
HD35ED 14bN TV	22,000	2 s	T, RH, T _D , T _w , AH, MR, PVP, P _{ATM}
HD35ED 14bN TVI	22,000	2 s	T, RH, T _D , T _w , AH, MR, PVP, P _{ATM}
HD35ED 1N4r...TV	22,000	1 s	T, RH, T _D , T _w , AH, MR, PVP, ΔP
HD35ED 4r...	68,000	1 s	ΔP
HD35ED 1NI TCV	44,000	1 s	T, RH, T _D , T _w , AH, MR, PVP, I
HD35ED 1NI2 TCV	44,000	1 s	T, RH, T _D , T _w , AH, MR, PVP, I
HD35ED 1NI TV	44,000	1 s	T, RH, T _D , T _w , AH, MR, PVP, I
HD35ED 14bNI TCV	36,000	2 s	T, RH, T _D , T _w , AH, MR, PVP, P _{ATM} , I
HD35ED 14bNI2 TCV	36,000	2 s	T, RH, T _D , T _w , AH, MR, PVP, P _{ATM} , I
HD35ED 14bNI TV	36,000	2 s	T, RH, T _D , T _w , AH, MR, PVP, P _{ATM} , I
HD35ED 1NIU TCV	32,000	1 s	T, RH, T _D , T _w , AH, MR, PVP, I, UVA, P _{UV}
HD35ED 1NIU TV	32,000	1 s	T, RH, T _D , T _w , AH, MR, PVP, I, UVA, P _{UV}
HD35ED1NUBTCV	44,000	1 s	T, RH, T _D , T _w , AH, MR, PVP, UVB
HD35ED1NUCTCV	44,000	1 s	T, RH, T _D , T _w , AH, MR, PVP, UVC
HD35ED 14bNIU TCV	32,000	2 s	T, RH, T _D , T _w , AH, MR, PVP, P _{ATM} , I, UVA, P _{UV}
HD35ED 14bNIU TV	32,000	2 s	T, RH, T _D , T _w , AH, MR, PVP, P _{ATM} , I, UVA, P _{UV}
HD35ED 1NB	44,000	10 s	T, RH, T _D , T _w , AH, MR, PVP, CO ₂
HD35ED 1NAB	36,000	10 s	T, RH, T _D , T _w , AH, MR, PVP, CO, CO ₂
HD35ED 14bNAB	32,000	10 s	T, RH, T _D , T _w , AH, MR, PVP, P _{ATM} , CO, CO ₂
HD35ED H	see below	5 s	depends on the inputs configuration
	68,000 with only one input used (not as counter)		
	52,000 with two inputs used (not as counter) or one input used as counter		
	42,000 with three inputs used (not as counter) or two inputs one of which as counter		
	36,000 with three inputs used, one of which as counter		

(*) **List of the quantities:**

- | | |
|--|--|
| T: temperature | ΔP: differential pressure |
| RH: relative humidity | I: illuminance |
| T_D: dew point | UVA: UVA irradiance |
| T_w: wet bulb temperature | UVB: UVB irradiance |
| AH: absolute humidity | UVC: UVC irradiance |
| MR: mixing ratio | P_{UV}: proportion of UV present (μW/lumen) |
| PVP: partial vapour pressure | CO: carbon monoxide |
| P_{ATM}: atmospheric pressure | CO₂: carbon dioxide |

(**) One sample consists of all the quantities measured and calculated by the data logger at the same instant of acquisition. For example, the model HD35ED1NAB measures four quantities and calculates five quantities (the derived humidity quantities) and one sample includes one temperature measure, one CO measure, one CO₂ measure and six humidity measures (the relative humidity measure plus the five derived quantities).

TAB. 8.7.2: measurement characteristics (instrument in line with sensor)

For all data logger models except versions with terminal header inputs

Temperature - NTC10K Sensor	
For ...N...TC and ...TV versions	
<i>Sensor</i>	NTC 10 k Ω @ 25 °C
<i>Measuring range</i>	-40...+105 °C
<i>Resolution (instrument)</i>	0.1 °C
<i>Accuracy</i>	± 0.3 °C in the range 0...+70 °C / ± 0.4 °C outside
<i>Stability</i>	0.1 °C/year
Temperature – Sensor integrated in RH module	
For ...TVI versions and HD35ED[G]1NB, HD35ED[G]1NAB, HD35ED[G]14bNAB models	
<i>Sensor</i>	Sensor integrated in humidity module
<i>Measuring range</i>	-40...+105 °C
<i>Resolution (instrument)</i>	0.1 °C
<i>Accuracy</i>	± 0.2 °C in the range 0...+60 °C $\pm (0.2 - 0.05 * T)$ °C in the range T=-40...0 °C $\pm [0.2 + 0.032 * (T-60)]$ °C in the range T=+60...+105 °C
<i>Stability</i>	0.05 °C/year
Temperature - Pt100/Pt1000 Sensor	
For ...7P...TC versions	
<i>Sensor</i>	Pt100 / Pt1000 1/3 DIN thin film
<i>Measuring range</i>	-100...+350 °C max. for probes measuring only temperature (the measuring range can be limited by the operating temperature of the used probe) -40...+150 °C for T/RH combined probes HD3517ETC...
<i>Resolution (instrument)</i>	0.1 °C
<i>Accuracy</i>	1/3 DIN
<i>Stability</i>	0.1 °C/year
Relative Humidity	
For ...TC and ...TV versions	
<i>Sensor</i>	Capacitive (the sensor can be calibrated by user)
<i>Measuring range</i>	0...100 %RH
<i>Resolution (instrument)</i>	0.1 %
<i>Accuracy</i>	<i>standard</i> ± 2.5 % RH (0..90 % RH) / ± 3.5 % RH (remaining range) <i>with HP3517E...</i> ± 2 % RH (0..90 % RH) / ± 3 % RH (remaining range)
<i>Sensor operating temperature</i>	-20...+80 °C standard -40...+150 °C with HP3517E...
<i>Response time</i>	T ₉₀ < 20 s (air speed = 2 m/s without filter)
<i>Temperature drift</i>	± 2 % over the whole operating temperature range
<i>Stability</i>	1%/year
Relative humidity	
For...TVI versions and HD35ED[G]1NB, HD35ED[G]1NAB, HD35ED[G]14bNAB models	
<i>Sensor</i>	Capacitive (the sensor can not be calibrated by user)
<i>Measuring range</i>	0...100 %RH
<i>Resolution (instrument)</i>	0.1 %
<i>Accuracy</i>	± 1.8 %RH (0..80 % RH) $\pm [1.8 + 0.11 * (RH -80)]$ % RH (remaining range)
<i>Sensor operating temperature</i>	-40...+105 °C (R.H. max=[100-2*(T-80)] @ T=80...105 °C)
<i>Response time</i>	T ₆₃ < 4 s (air speed = 2 m/s,without filter)
<i>Temperature drift</i>	± 2 % over the whole operating temperature range
<i>Stability</i>	< 0.5%/year

Atmospheric Pressure																
<i>Sensor</i>	Piezo-resistive															
<i>Measuring range</i>	300...1100 hPa															
<i>Resolution (instrument)</i>	0.1 hPa															
<i>Accuracy</i>	± 0.5 hPa (800...1100 hPa) @ T=25°C ± 1 hPa (300...1100 hPa) @ T=0...50°C															
<i>Stability</i>	1 hPa/anno															
<i>Temperature drift</i>	±3 hPa tra -20...+60 °C															
Differential Pressure																
<i>Sensor</i>	range 1...4: Piezoresistive range 5: Thermal mass flow sensing element															
<i>Measuring range</i>	According to the model: <table border="1"> <thead> <tr> <th>range 1</th> <th>range 2</th> <th>range 3</th> <th>range 4</th> <th>range 5</th> </tr> </thead> <tbody> <tr> <td>±2.5 hPa</td> <td>±10 hPa</td> <td>±100 hPa</td> <td>±2000 hPa</td> <td>±125 Pa</td> </tr> <tr> <td>0.001 hPa</td> <td>0.005 hPa</td> <td>0.05 hPa</td> <td>1 hPa</td> <td>0.01 Pa</td> </tr> </tbody> </table>	range 1	range 2	range 3	range 4	range 5	±2.5 hPa	±10 hPa	±100 hPa	±2000 hPa	±125 Pa	0.001 hPa	0.005 hPa	0.05 hPa	1 hPa	0.01 Pa
range 1	range 2	range 3	range 4	range 5												
±2.5 hPa	±10 hPa	±100 hPa	±2000 hPa	±125 Pa												
0.001 hPa	0.005 hPa	0.05 hPa	1 hPa	0.01 Pa												
<i>Resolution (instrument)</i>	0.001 hPa 0.005 hPa 0.05 hPa 1 hPa 0.01 Pa															
<i>Accuracy</i>	range 1...4: ± 1% f.s. range 5: ± 3% of reading, ± 0.1 Pa @ 0 Pa over the entire compensated temperature range (0...50 °C)															
<i>Connection</i>	Tube Ø 5 mm. In the model r5 it is recommended to use tubes with at least 5 mm internal diameter.															
Carbon Monoxide (CO)																
<i>Sensor</i>	Electrochemical cell															
<i>Measuring range</i>	0 ... 500 ppm															
<i>Resolution (instrument)</i>	1 ppm															
<i>Accuracy</i>	± (3 ppm + 3% of measurement)															
<i>Operating temperature</i>	-5...50 °C															
<i>Response time</i>	T ₉₀ < 50 s															
<i>Stability</i>	5% of measurement /year															
<i>Sensor life</i>	> 5 years in normal environmental conditions															
Carbon Dioxide (CO₂)																
<i>Sensor</i>	Non-dispersive infrared rays (NDIR)															
<i>Measuring range</i>	0...5000 ppm															
<i>Resolution (instrument)</i>	1 ppm															
<i>Accuracy</i>	± (50 ppm + 3% of measurement) @ 20 °C and 1013 hPa															
<i>Operating temperature</i>	-5...50 °C															
<i>Response time</i>	T ₉₀ < 120 s (air speed= 2 m/s)															
<i>Stability</i>	5% of measurement/5 years															
<i>Temperature drift</i>	0.1% f.s. / °C															
UVA Irradiance																
<i>Sensor</i>	Photodiode															
<i>Measuring range</i>	0...10,000 mW/m ²															
<i>Resolution (instrument)</i>	1 mW/m ² (0...2,000 mW/m ²), 5 mW/m ² (> 2,000... mW/m ²)															
<i>Spectral range</i>	UVA, peak ≅ 360 nm															
<i>Spectral response</i>	See graph 2															
<i>Calibration uncertainty</i>	<5%															
<i>f₂ (response as cosine law)</i>	<6%															
<i>f₃ (linearity)</i>	<1%															
<i>f₄ (instrument reading error)</i>	±1 digit															
<i>f₅ (fatigue)</i>	<0.5%															
<i>One year drift</i>	<2%															
<i>Operating temperature</i>	0...50 °C															

UVB Irradiance	
<i>Sensor</i>	Photodiode
<i>Measuring range</i>	0...100 W/m ²
<i>Resolution (instrument)</i>	0.01 W/m ² (0...10 W/m ²), 0.1 W/m ² (10...100 W/m ²)
<i>Spectral range</i>	UVB, peak \cong 305 nm
<i>Spectral response</i>	See graph 3
<i>Calibration uncertainty</i>	<5%
<i>f₂ (response as cosine law)</i>	<6%
<i>f₃ (linearity)</i>	<2%
<i>f₄ (instrument reading error)</i>	\pm 1 digit
<i>f₅ (fatigue)</i>	<0.5%
<i>One year drift</i>	<2%
<i>Operating temperature</i>	0...50 °C
UVC Irradiance	
<i>Sensor</i>	Photodiode
<i>Measuring range</i>	0...100 W/m ²
<i>Resolution (instrument)</i>	0.01 W/m ² (0...10 W/m ²), 0.1 W/m ² (10...100 W/m ²)
<i>Spectral range</i>	UVC, peak \cong 260 nm
<i>Spectral response</i>	See graph 4
<i>Calibration uncertainty</i>	<5%
<i>f₂ (response as cosine law)</i>	<6%
<i>f₃ (linearity)</i>	<1%
<i>f₄ (instrument reading error)</i>	\pm 1 digit
<i>f₅ (fatigue)</i>	<0.5%
<i>One year drift</i>	<2%
<i>Operating temperature</i>	0...50 °C
Illuminance	
<i>Sensor</i>	Photodiode
<i>Measuring range</i>	I: 0...20,000 lux I2: 0...200,000 lux
<i>Resolution (instrument)</i>	I: 1 lux (0...2,000 lux), 10 lux (>2,000 lux) I2: 10 lux (0...20,000 lux), 100 lux (>20,000 lux)
<i>Spectral range</i>	In accordance with standard photopic curve V(λ)
<i>Spectral response</i>	See graph 1
<i>a (temperature coefficient) f₆(T)</i>	<0.05% K
<i>Calibration uncertainty</i>	<4%
<i>f₁ (accordance with photopic response V(λ))</i>	<6%
<i>f₂ (response as cosine law)</i>	<3%
<i>f₃ (linearity)</i>	<1%
<i>f₄ (instrument reading error)</i>	<0.5%
<i>f₅ (fatigue)</i>	<0.5%
<i>Class</i>	B
<i>One year drift</i>	<1%
<i>Operating temperature</i>	0...50 °C
<i>Reference standard</i>	CIE n°69 – UNI 11142

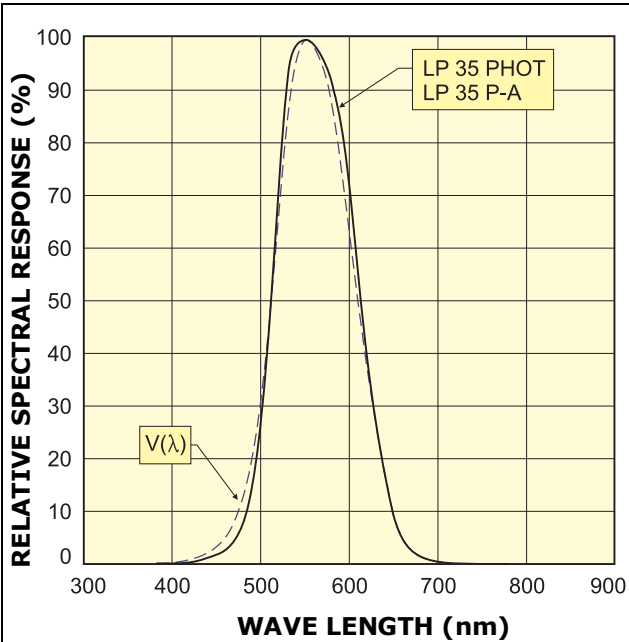

Graph 1 – Relative spectral response of illuminance sensor

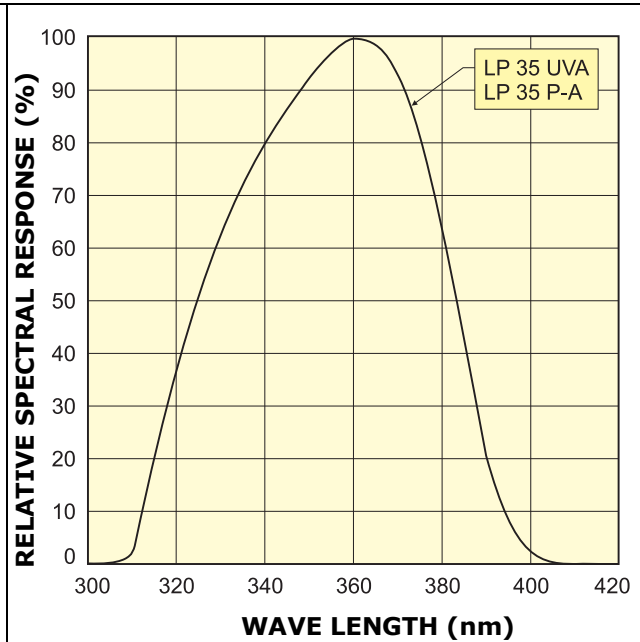

Graph 2 – Relative spectral response of UVA irradiance sensor

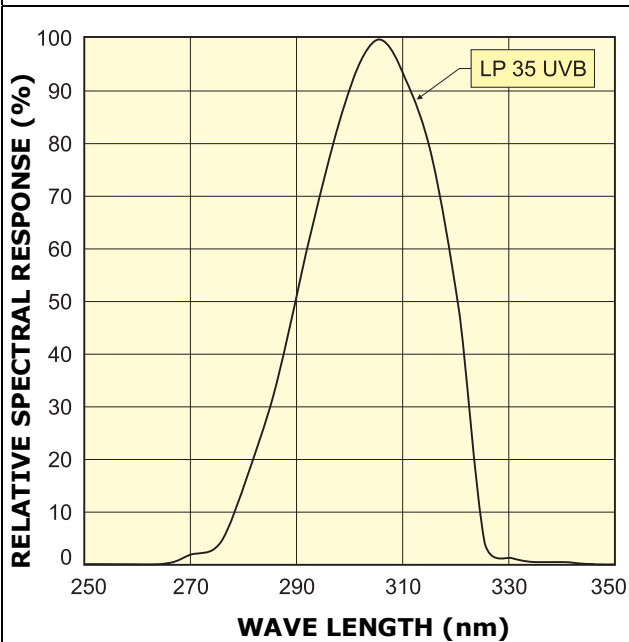

Graph 3 – Relative spectral response of UVB irradiance sensor

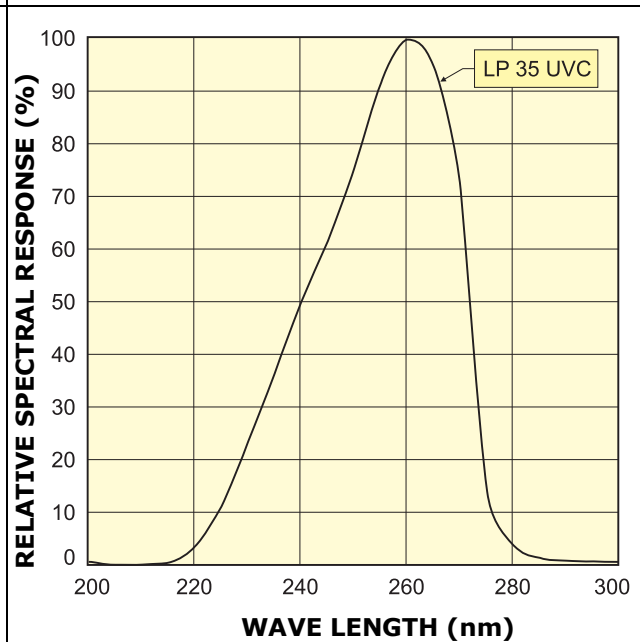

Graph 4 – Relative spectral response of UVC irradiance sensor

TAB. 8.7.3: Characteristics of terminal header inputs of HD35EDH instrument:

Pt100 / Pt1000	
Measuring range	-200...+650 °C
Resolution	0.1 °C
Accuracy	± 0.1 °C (excluding probe error)
Sensor coefficient	$\alpha=0.00385 \text{ }^\circ\text{C}^{-1}$
Connection	2, 3 or 4 wires
Thermocouple	
Thermocouple type	K, J, T, N, E. The inputs are not isolated, use thermocouples with isolated hot junction.
Measuring range	type K: -200...+1370 °C type J: -100...+750 °C type E: -200...+750 °C type T: -200...+400 °C type N: -200...+1300 °C
Resolution	0.1 °C
Accuracy (excluding probe error)	type K: ± 0.1 °C (< 600 °C) type E: ± 0.1 °C (< 300 °C) ± 0.2 °C (> 600 °C) ± 0.2 °C (> 300 °C) type N: ± 0.1 °C (< 600 °C) type J: ± 0.1 °C ± 0.2 °C (> 600 °C) type T: ± 0.1 °C
Input 0/4...20 mA	
Shunt resistance	Internal (50 Ω)
Resolution	16 bit
Accuracy	± 2 μA
Inputs 0...50 mV and 0...1 V	
Input Resistance	100 M Ω
Resolution	16 bit
Accuracy	± 0.01% f.s.
Inputs for counting the switchings of a voltage-free contact	
Switching frequency	50 Hz max.
Hold Time	10 ms min.
Potentiometer input	
Potentiometer	Typically 10 k Ω
Resolution	16 bit
Accuracy	± 0.01% f.s.

9 HD35EDW... WATERPROOF DATA LOGGERS

9.1 DESCRIPTION

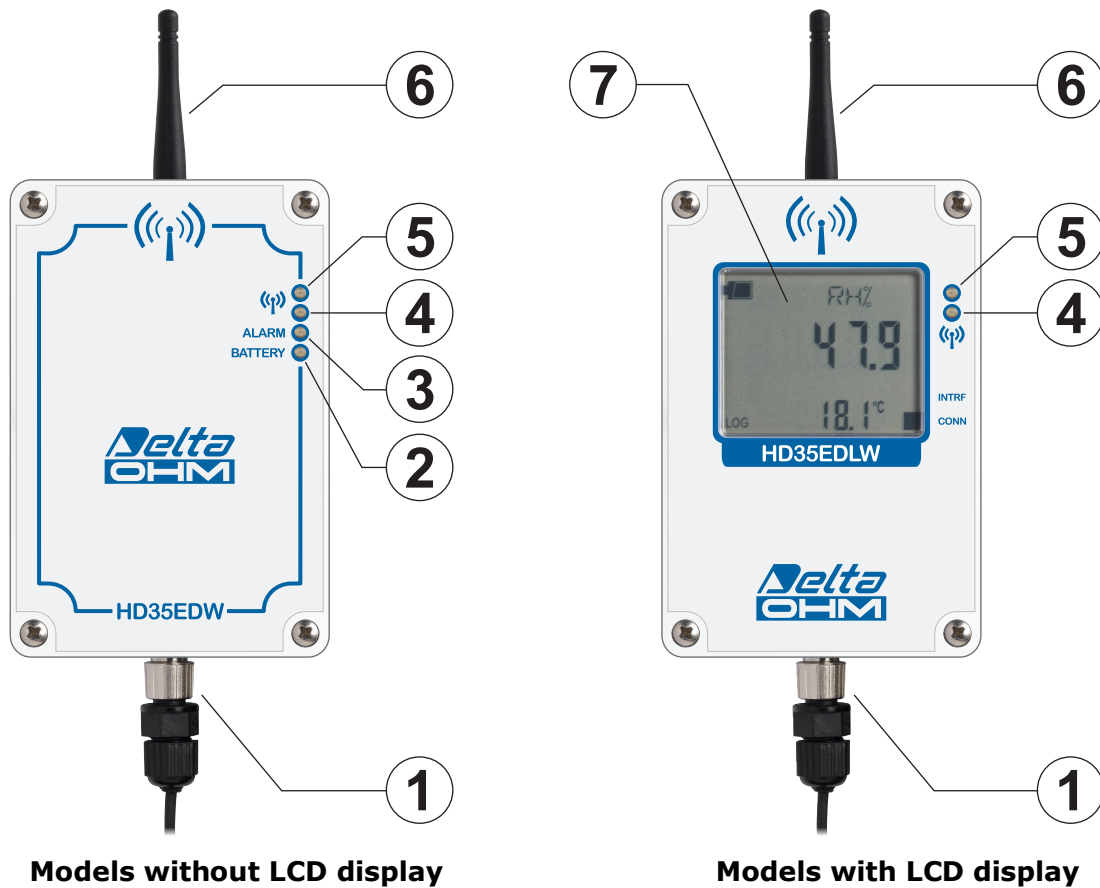

1. Probes and/or integrated sensors. The aspect of the lower part of the data logger depends on the model (see next paragraph).
2. BATTERY LED: green color, indicates the charge level of the internal battery. As the battery runs low, the LED blinks with a lower and lower frequency (the blink period increases of 1 second for each 10% decrease of the battery charge).
3. ALARM LED: red color, it blinks when the measurement is in alarm condition.
4. Green RF LED: blinks if data transmission was successful.
5. Red RF LED: blinks to indicate that data transmission has failed.
6. RF Antenna. The antenna is external for outdoor installation with protection shield against solar radiations; the antenna is internal for indoor installation.
7. Custom LCD display.

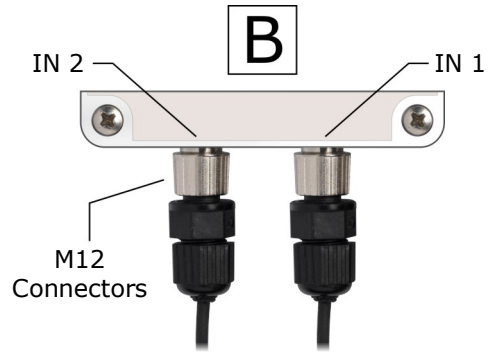
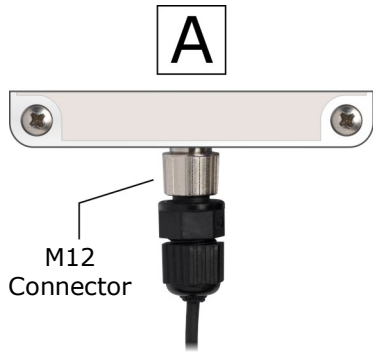

Model	Connectable probes
HD35EDW7P/1TC	TP35... (Pt100 / Pt1000)
HD35EDWN/1TC	TP35N... (NTC)
HD35EDW1NTC	HP3517TC... / TP35N... (NTC)
HD35EDW17PTC	HP3517ETC...
HD35EDW14bNTC	HP3517TC... / TP35N... (NTC)
HD35EDW14b7PTC	HP3517ETC...
HD35EDWRTC	LP PYRA 02 / LP PYRA 03 LP SILICON-PYRA 04
HD35EDWPTC	HD2013 / HD2015
HD35EDWSTC	HP3510.1 / HP3510.2

Model	Connectable probes	
HD35EDW7P/2TC	TP35... (Pt100 / Pt1000)	
HD35EDWN/2TC	TP35N... (NTC)	
HD35EDW1N/2TC	IN 1	HP3517TC... TP35N... (NTC)
	IN 2	TP35N... (NTC)
HD35EDW1NRTC	IN 1	HP3517TC... TP35N... (NTC)
	IN 2	LP PYRA 02 / LP PYRA 03 LP SILICON-PYRA 04
HD35EDW7PRTC	IN 1	LP PYRA 02 / LP PYRA 03 LP SILICON-PYRA 04
	IN 2	TP35878ISS...
HD35EDWNPTC	IN 1	HD2013 / HD2015
	IN 2	HP3507TC...
HD35EDWRPTC	IN 1	HD2013 / HD2015
	IN 2	LP PYRA 02 / LP PYRA 03 LP SILICON-PYRA 04
HD35EDW1NLTC	IN 1	HP3517TC... TP35N... (NTC)
	IN 2	HP3501
HD35EDWS/2TC	HP3510.1 / HP3510.2	

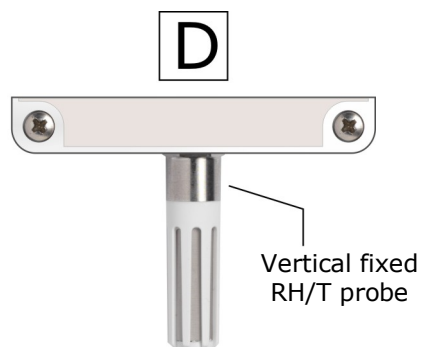
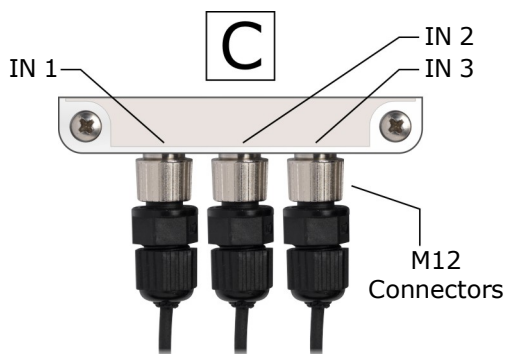

Model	Connectable probes	
HD35EDW7P/3TC	TP35... (Pt100 / Pt1000)	
HD35EDWN/3TC	TP35N... (NTC)	
HD35EDW1N7PRTC	IN 1	TP35878ISS...
	IN 2	LP PYRA 02 / LP PYRA 03 LP SILICON-PYRA 04
	IN 3	HP3517TC... / TP35N... (NTC)
HD35EDWS/3TC	HP3510.1 / HP3510.2	

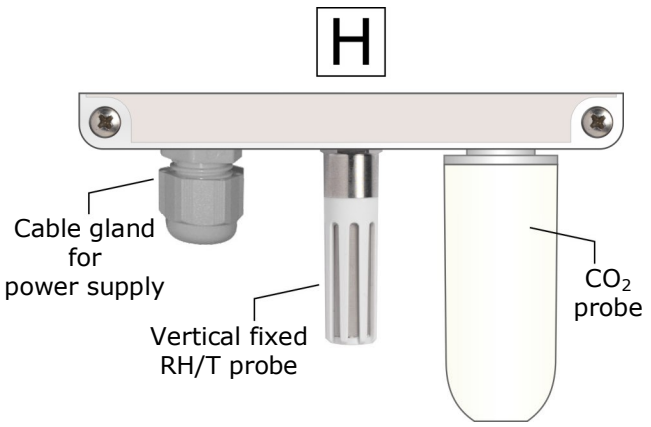
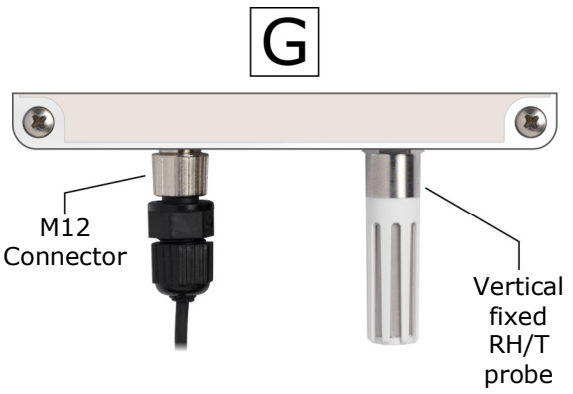
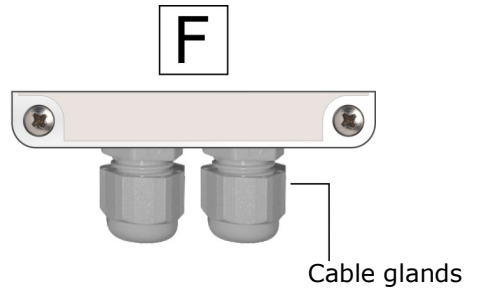
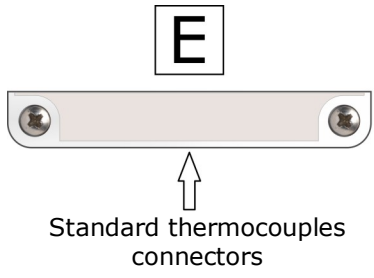



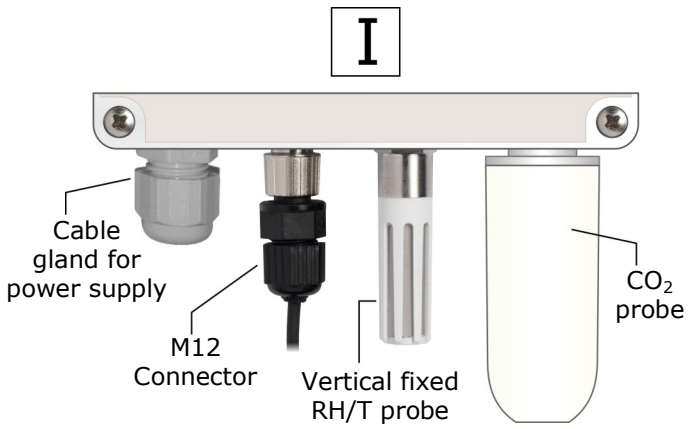







Model	Connectable probes
HD35EDW1NI2TCV	LP35PHOT03BL



Model	Connectable probes
HD35EDW1NBITCV	LP35PHOT
HD35EDW1NBI2TCV	LP35PHOT
HD35EDW1NBI3TCV	LP35PAR

Data logger models in waterproof housing

In order to highlight the physical quantities measured by data loggers, order codes include some identification characters for the various quantities, according to the following convention:

	1 = Humidity
	4b = Atmospheric Pressure (barometer)
	N = Temperature with NTC10K sensor (N/1 = 1 channel, N/2 = 2 channels, N/3 = 3 channels)
	7P = Temperature with Pt100/Pt1000 sensor (7P/1 = 1 channel, 7P/2 = 2 channels, 7P/3 = 3 channels)
	K = Temperature with thermocouple sensor (K/4 = 4 channels)
	R = Solar radiation (pyranometer) / I = Illuminance (lux)
	P = Rainfall quantity
	V = Acceleration
	L = Leaf wetness
	S = Soil volumetric water content
	B = Carbon dioxide (CO ₂)

TC = Probe with cable

TV = Fixed vertical temperature and/or R.H. probe without cable (R.H. sensor can be calibrated by user)

TVI = Fixed vertical temperature and R.H. probe without cable (R.H. sensor can not be calibrated by user)

TCV = Illuminance/UV irradiance or temperature only probe with cable and fixed vertical temperature/R.H. probe without cable (R.H. sensor can be calibrated by user)

Models measuring temperature and humidity with combined probe with cable (...**TC** models) use the probes of the **HP3517...** series with **relative humidity sensor that can be calibrated by user** and NTC 10KΩ @ 25 °C or Pt100 temperature sensor according to the model. **The replacement of the HP3517... probe requires instrument recalibration in line with the new probe.**









Models with M12 connectors equipped with inputs for the measurement of temperature only use **TP35...** series temperature probes with NTC 10KΩ @ 25 °C or Pt100/Pt1000 sensor.









In models with 2 or 3 M12 connectors, the input number is shown on the connector side.

In models measuring the atmospheric pressure, the sensor is inside the instrument.

Refer to the figures indicated in the last column of the table below for probes connection modes and the position of the integrated sensors in the various models.

TAB. 9.1.1: models of data loggers in waterproof housing

Model	MEASUREMENTS											INPUTS		Fig.			
												Number of M12 connectors	Built-in sensors				
	NTC 10K	Pt100 Pt1000	TC	Solar panel	RH	Patm	PYRA / Lux	Rainfall	<i>a</i>	Leaf	CO ₂						
HD35EDW 7P/1 TC		•										1		A			
HD35EDW 7P/2 TC		•										2		B			
HD35EDW 7P/3 TC		•										3		C			
HD35EDW N/1 TC	•											1		A			
HD35EDW N/2 TC	•											2		B			
HD35EDW N/3 TC	•											3		C			
HD35EDW N TV	•												•	D			
HD35EDW K/4 TC			•									4 standard TC conn.		E			
HD35EDW 1 TV					•								•	D			
HD35EDW 1 TVI					•								•	D			
HD35EDW 1N TC	•				•							1		A			
HD35EDW 17P TC		•			•							1		A			
HD35EDW 1N TV	•				•								•	D			
HD35EDW 1N TVI	Sensor integrated in RH module				•								•	D			
HD35EDW 1N/2 TC	•				•							2		B			
HD35EDW 14bN TC	•				•	•						1	Patm	A			
HD35EDW 14b7P TC		•			•	•						1	Patm	A			
HD35EDW 1NV	•				•								•	D			
HD35EDW R TC							PYRA					1		A			
HD35EDW 1NR TC	•				•		PYRA					2		B			
HD35EDW 7PR TC				•			PYRA					2		B			
HD35EDW 1N7PR TC	•			•	•		PYRA					3		C			
HD35EDW NP TC	•							•				2		B			
HD35EDW RP TC							PYRA	•				2		B			
HD35EDW P TC								•				1		A			
HD35EDW 1NL TC	•				•						•	2		B			
HD35EDW S TC	Soil temperature and volumetric water content											1		A			
HD35EDW S/2 TC															2		B
HD35EDW S/3 TC																3	
HD35EDW 1NI2 TCV	•				•		Lux					1	T / UR	G			
HD35EDW 1NB TV	•				•						•		•	H			

Model	MEASUREMENTS											INPUTS		Fig.
												Number of M12 connectors	Built-in sensors	
	NTC 10K	Pt100 Pt1000	TC	Solar panel	RH	Patm	PYRA / Lux	Rainfall	<i>a</i>	Leaf	CO ₂			
HD35EDW 1NBI TCV	•				•		Lux				•	1	T/UR/CO ₂	I
HD35EDW1NBI2TCV	•				•		Lux				•	1	T/UR/CO ₂	I
HD35EDW1NBI3TCV	•				•		PAR				•	1	T/UR/CO ₂	I
HD35EDW H	Transmitters with 0÷20 mA, 4÷20 mA, 0÷50 mV, 0÷1 V or 0÷10 V output Pt100 / Pt1000 Sensors, K, J, T, N, E thermocouples Sensors with voltage-free contact or potentiometric output											4 terminal inputs	F	

9.2 INSTALLATION OF WATERPROOF HOUSING

The housing for waterproof models can be fixed to a wall or, for outdoor installations, to a 40 mm diameter mast by means of HD2003.77/40 clamping.

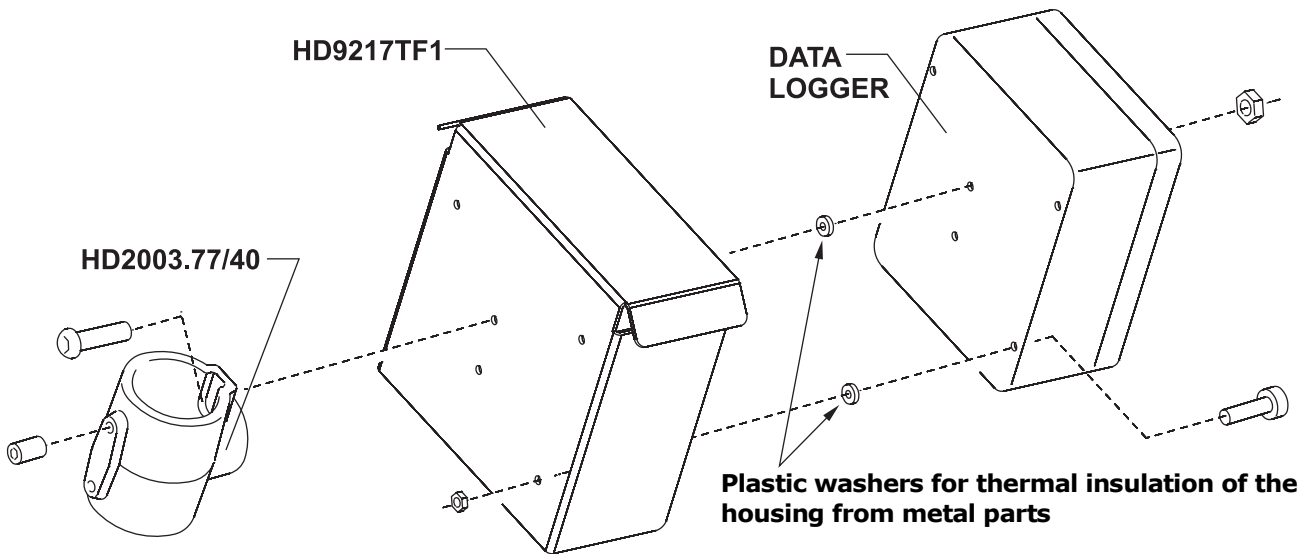

Fig. 9.2.1: installation of waterproof housing

For outdoor installations, use the optional protection shield against solar radiations (**HD9217TF1** or **HD32MT4.6**).

Data loggers supplied with clamping already mounted on the back of the housing are equipped with protection devices against over-voltages connected to the clamping. For a correct operation of the protecting devices, the yellow/green wire with fast-on connector connected to the clamping should be connected to ground.

The outdoor installation of the combined temperature and relative humidity probe requires HD9007A-1 or HD9007A-2 protection against solar radiations.

9.3 CONNECTION TO THE WIRELESS NETWORK

The device can be connected and disconnected to/from the wireless network **by pressing for 5 seconds** the internal connection button (CONNECT/DISCONNECT button).

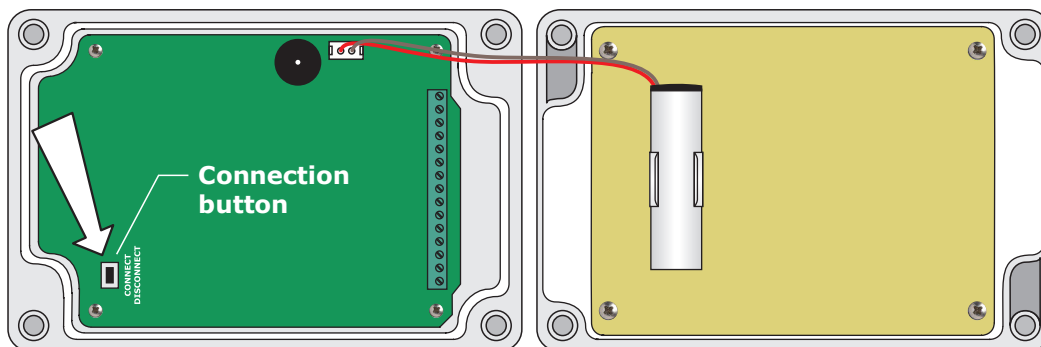

Fig. 9.3.1: internal connection button

If the device is disconnected, by pressing for 5 seconds the connection button the buzzer emits a beep and the green RF LED blinks for 1 second to indicate the start of the connection procedure. If the device belongs to a wireless network and the base unit is reachable, after connection the buzzer emits a second beep and the green RF LED blinks during data transmission. If the device doesn't belong to a wireless network and the base unit is not reachable, the second beep of the buzzer is not emitted and the red RF LED will blink.

If the device is connected, by pressing for 5 seconds the connection button the buzzer emits a beep, the red RF LED blinks for 1 second and the device is disconnected.

In data loggers with LCD display, the connection status is signaled also by the connection icon on the display (see figure 3.6 on page 10):

- the icon is steady on if the data logger is connected;
- the icon blinks if the data logger is trying to connect (the icon will be steady on after connection or will go on blinking if the base unit cannot be reached or the data logger doesn't belong to a wireless network);
- the icon is off if the data logger is not connected.

PING function:

In the devices connected to a wireless network it is possible to check if the base unit can be reached by briefly pressing the connection button: if the green RF LED is blinking, it means that the base unit is reachable, otherwise it will be the red RF LED to blink.

9.4 DATA LOGGER WITH LCD OPTION

Through HD35AP-S software, you can select the measurement to be displayed on the main line of the display or set the automatic alternation of measured quantities. Information on the connection status, logging (in progress/disabled), and battery charge level are shown. The secondary line displays temperature (if measured by the model).

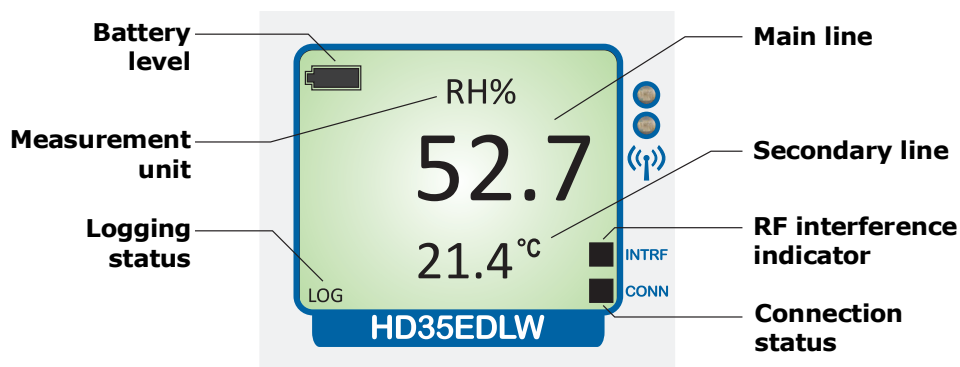

Fig. 9.4.1: custom LCD

9.5 CONNECTING THE MODEL HD35EDWH WITH TERMINAL HEADER INPUTS

HD35ED[L]WH model has four terminal header inputs. Each input can be configured as a Pt100/Pt1000, thermocouple, 0/4...20 mA (shunt resistance inside), 0...50 mV, 0...1 V, 0...10 V or potentiometric input. Only input 4 can be also configured as pulse counter (count of voltage-free contact switchings).

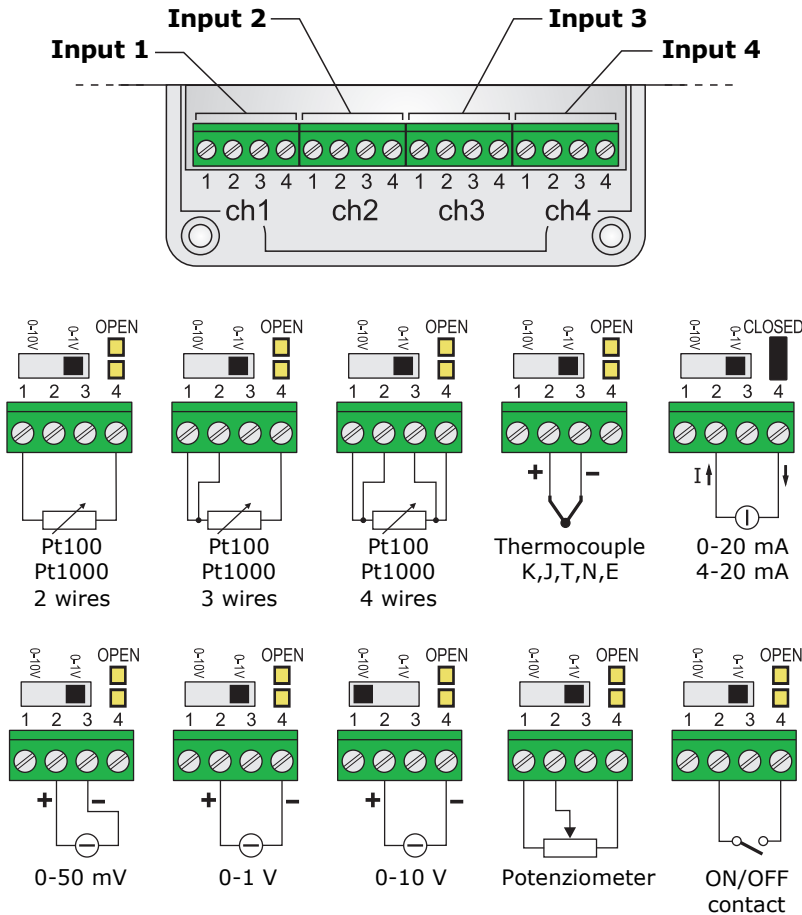

Fig. 9.5.1: sensor connection in HD35EDWH model

If a channel is configured as 0-10 V input, set the switch on the terminals of the channel to 0-10V. In all other cases, set the switch to 0-1V.

If a channel is configured as current input, insert the 50 Ω shunt resistance closing the jumper placed above the terminals of the relevant channel. In all the other configurations, leave the jumper open.

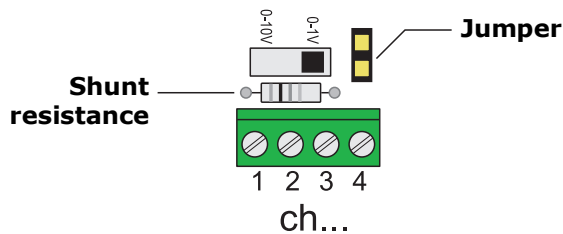

Fig. 9.5.2: shunt resistance for current input

The current input accepts any value in the range 0 to 20 mA.

Configuration of inputs is done with the HD35AP-S software (see software instructions).

The model HD35ED[L]WH is available in the version with battery supply (connect the battery to the connector shown in Fig. 9.5.3) or in the version for 7...28 Vdc external power supply (connect the external power supply to the terminals shown in Fig. 9.5.4).

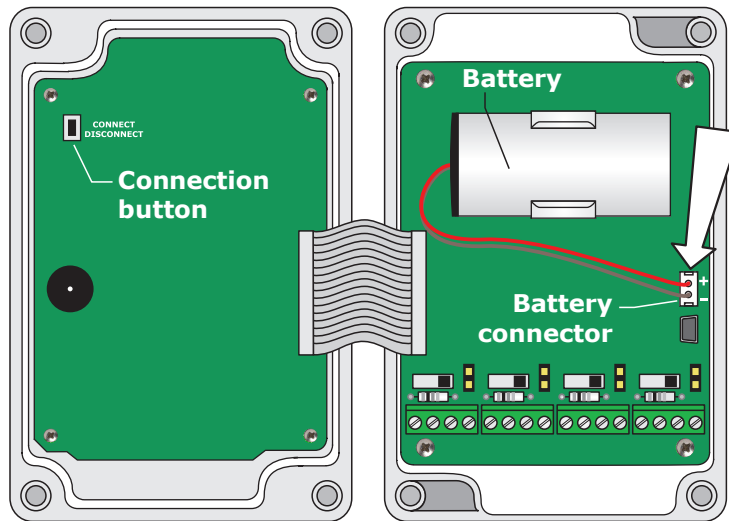

Fig. 9.5.3: connection of the battery in the model HD35ED[L]WH

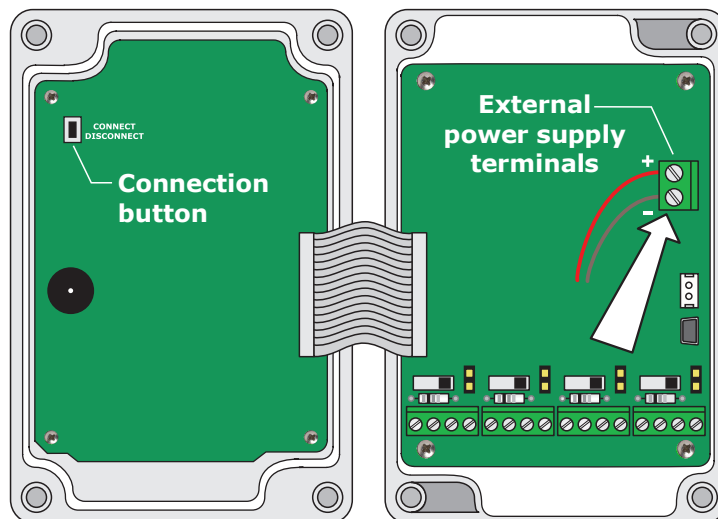

Fig. 9.5.4: connection of the external power supply in the model HD35ED[L]WHE

9.6 CONNECTING THE MODEL HD35EDW-MB WITH RS485 MODBUS-RTU INPUT

HD35ED[L]W-MB model has:

- 7...30 Vdc power supply input (terminals 1, 2).
- Switched power supply output (terminals 3, 4). It has the same value as the power supply input, but it is **active only during the measurement acquisition phase**. The output can be used to power the sensors.
- RS485 port (terminals 5, 6, 7) with Modbus-RTU protocol for the connection of the sensors.
- Potential-free contact input (terminals 8, 9). For example, a rain gauge with contact output can be connected.

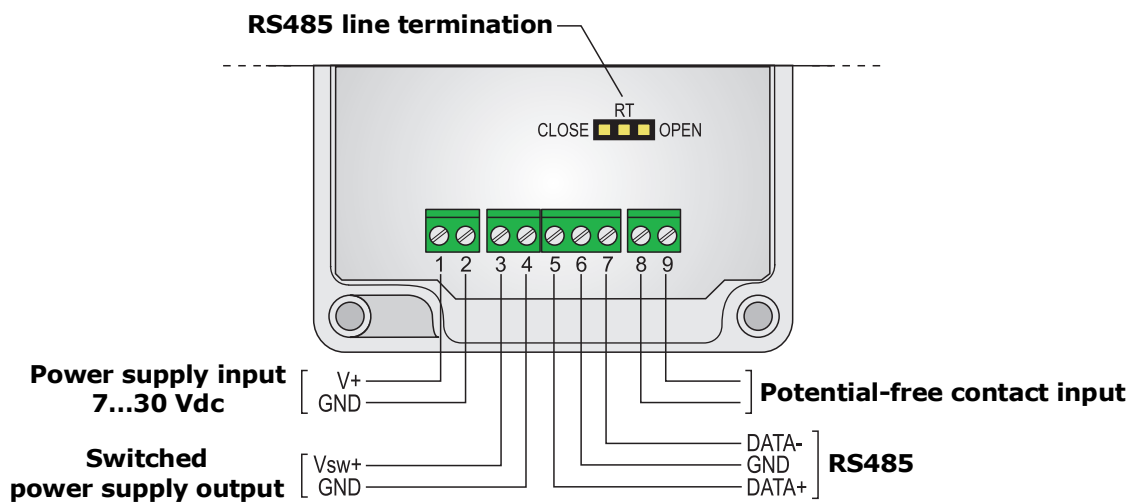

Fig. 9.6.1: connection of HD35EDW-MB model

The jumper placed above the terminals allows inserting the termination resistance for long distance RS485 connection. Place the jumper between the **RT** and **CLOSE** indications to connect the termination resistance. Place the short jumper between the **RT** and **OPEN** indications to disconnect the resistance.

Note: in the HD35ED[L]W-MB model, near the connection button (CONNECT/DISCONNECT) there are a switch (RUN/PROG) and a button (RF RESET) that are used only to update the firmware of the instrument in the 915.9-929.7 MHz radio frequency version (option J). In normal operation, leave the switch in RUN position.

9.7 ADAPTER FOR CO₂ CALIBRATION WITH THE NITROGEN CYLINDER

To calibrate the CO₂ sensor at 0 ppm with the aid of the nitrogen cylinder, unscrew the probe filter, screw the **HD31.B3A** adapter and connect the nitrogen cylinder (MINICAN.12A); adjust the bottle flow meter to get a constant flow between 0.3 and 0.5 l/min.

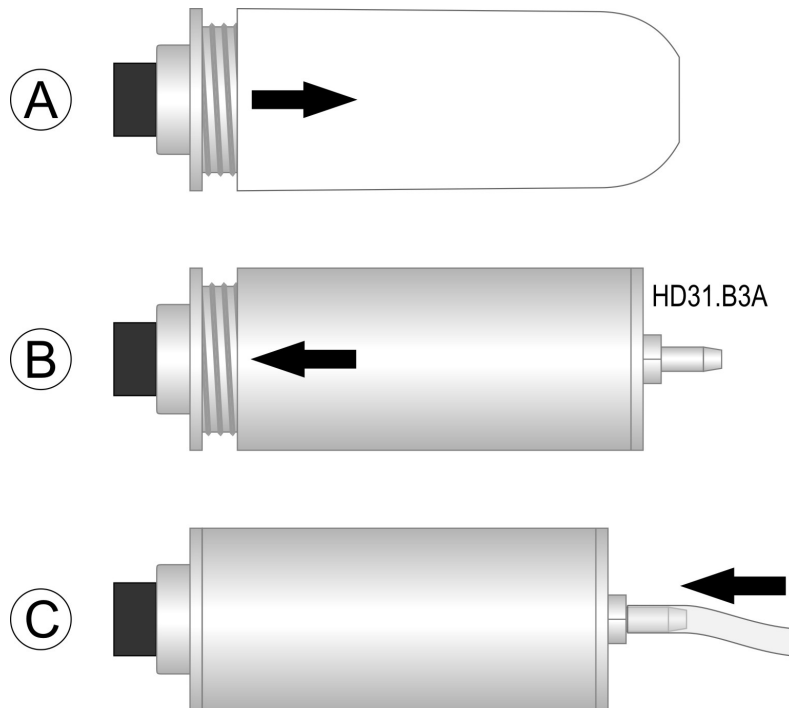

Fig. 9.7.1: CO₂ calibration with nitrogen cylinder

9.8 RAIN GAUGE CONNECTION

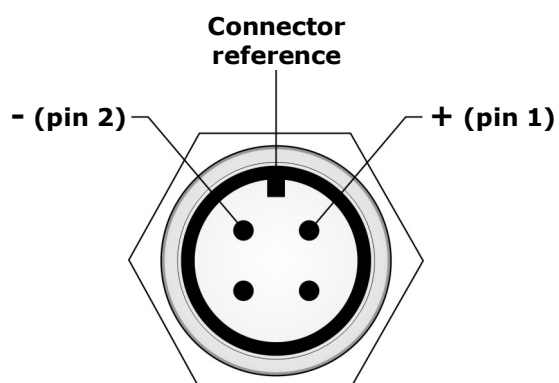

Fig. 9.8.1: external view of the instrument M12 connector

9.9 TECHNICAL CHARACTERISTICS OF DATA LOGGERS IN WATERPROOF HOUSING

<i>Transmission frequency</i>	868 MHz, 902-928 MHz or 915.9-929.7 MHz according to the model
<i>Antenna</i>	External for outdoor installation with protection shield against solar radiations. Internal for indoor installation.
<i>Transmission range</i>	In open field: 300 m (E, J)/ 180 m (U) with internal antenna towards base unit (except HD35APD) and repeaters. 180 m (E, U) with internal antenna towards base unit HD35APD. > 500 m (E, J, U) with external antenna towards base unit (except HD35APD) and repeaters. 180 m (E, U) with external antenna towards base unit HD35APD. (could be reduced in presence of obstacles or adverse atmospheric conditions)
<i>Measuring interval (*)</i>	1, 2, 5, 10, 15, 30 s / 1, 2, 5, 10, 15, 30, 60 min
<i>Logging and transmission interval (*)</i>	1, 2, 5, 10, 15, 30 s / 1, 2, 5, 10, 15, 30, 60 min
<i>Internal memory</i>	Circular management or stop logging if memory is full. The number of storable samples depends on the number of detected quantities (see table 9.5.1).
<i>Alarm</i>	Acoustic through internal buzzer
<i>Display</i>	Optional custom LCD
<i>Buttons</i>	Connection button inside the instrument
<i>LED indicators</i>	RF communication status. Models without LCD have alarm and battery level LEDs.
<i>Power supply</i>	Non rechargeable lithium thionyl chloride (Li-SOCl ₂) internal battery, 3.6 V, AA format (C format for HD35EDWK/4TC and HD35EDWH), 2-pole Molex 5264 connector. Optional 24 Vac/dc power supply. 7...30 Vdc external power supply (without internal battery) for the models with CO ₂ probe and the model with RS485 Modbus-RTU input.
<i>Battery life</i> <i>(without repeaters, direct communication with HD35AP...)</i>	4 years typical for HD35EDWK/4 and HD35EDWH models (with 10 s measurement interval and 30 s logging interval); 2 years typical for the other models, with 5 s measurement interval (10 s for HD35EDW7P/...TC, HD35EDW14bNTC, HD35EDW14b7PTC) and 30 s logging interval.
<i>Operating temperature and humidity</i>	-20...+70 °C / 0...100 %RH (-10...+60 °C for HD35EDW1NV)
<i>Dimensions</i>	See dimensional drawing
<i>Connectors for external probes with cable</i>	Depending on the model: M12 connectors, thermocouple connectors or terminal header inputs 3.5 mm pitch.
<i>Weight</i>	250 g approx. (battery included)
<i>Housing</i>	Polycarbonate
<i>Protection Degree</i>	IP 67
<i>Installation</i>	Wall mount or fixing to a 40mm diameter mast through the clamping HD2003.77/40 (optional). Protection shield against solar radiations HD9217TF1 or HD32MT4.6 (optional) for outdoor installation.

(*) Some models that measure many quantities may have a minimum interval higher than 1 second (see table 9.5.1).

TAB. 9.5.1: memory capacity of data loggers in waterproof housing

Model	Number of storable samples (**)	Minimum logging interval	Stored quantities (*)
HD35EDW 7P/1 TC	68,000	5 s	T
HD35EDW 7P/2 TC	52,000	5 s	T
HD35EDW 7P/3 TC	42,000	5 s	T
HD35EDW N/1 TC	68,000	1 s	T
HD35EDW N/2 TC	52,000	1 s	T
HD35EDW N/3 TC	42,000	1 s	T
HD35EDW N TV	68,000	1 s	T
HD35EDW K/4 TC	36,000	5 s	T
HD35EDW 1 TV	68,000	1 s	RH
HD35EDW 1 TVI	68,000	1 s	RH
HD35EDW 1N TC	24,000	1 s	T, RH, T _D , T _W , AH, MR, PVP
HD35EDW 17P TC	24,000	1 s	T, RH, T _D , T _W , AH, MR, PVP
HD35EDW 1N TV	24,000	1 s	T, RH, T _D , T _W , AH, MR, PVP
HD35EDW 1N TVI	24,000	1 s	T, RH, T _D , T _W , AH, MR, PVP
HD35EDW 1N/2 TC	22,000	1 s	T, RH, T _D , T _W , AH, MR, PVP
HD35EDW 14bN TC	22,000	2 s	T, RH, T _D , T _W , AH, MR, PVP, P _{ATM}
HD35EDW 14b7P TC	22,000	2 s	T, RH, T _D , T _W , AH, MR, PVP, P _{ATM}
HD35EDW R TC	42,000	1 s	R, D _R , mV
HD35EDW 1NR TC	24,000	1 s	T, RH, T _D , T _W , AH, R, D _R , mV
HD35EDW 7PR TC	36,000	1 s	T, R, D _R , mV
HD35EDW 1N7PR TC	22,000	1 s	T, RH, T _D , AH, R, D _R , mV
HD35EDW P TC	36,000	1 s	P, D _P , I _P
HD35EDW 1NL TC	22,000	1 s	T, RH, T _D , T _W , AH, MR, PVP, H _{LEAF}
HD35EDW S TC	52,000	1 s	T, VWC
HD35EDW S/2 TC	36,000	1 s	T, VWC
HD35EDW S/3 TC	26,000	1 s	T, VWC
HD35EDW 1NI2 TCV	30,000	10 s	T, RH, T _D , AH, I
HD35EDW 1NB TV	30,000	10 s	T, RH, T _D , AH, CO ₂
HD35EDW 1NBI TCV	26,000	10 s	T, RH, T _D , AH, I, CO ₂
HD35EDW1NBI2 TCV	26,000	10 s	T, RH, T _D , AH, I, CO ₂
HD35EDW1NBI3 TCV	26,000	10 s	T, RH, T _D , AH, PAR, CO ₂
HD35EDW H	see below	5 s	depends on the inputs configuration
	58,000 with only one input used (not as counter)		
	46,000 with two inputs used (not as counter) or one input used as counter		
	38,000 with three inputs used (not as counter) or two inputs one of which as counter		
	32,000 with four inputs used (not as counter) or three inputs one of which as counter		
	28,000 with four inputs used, one of which as counter		

(*) **List of the quantities:**

- | | |
|---|--|
| T: temperature | R: solar radiation (pyranometer) |
| RH: relative humidity | D_R: daily solar radiation (Wh/m ²) |
| T_D: dew point | mV: pyranometer output in mV |
| T_W: wet bulb temperature | P: rainfall quantity |
| AH: absolute humidity | D_P: daily rainfall quantity |
| MR: mixing ratio | I_P: rainfall rate (mm/h) |
| PVP: partial vapour pressure | H_{LEAF}: leaf wetness |
| P_{ATM}: atmospheric pressure | VWC: soil volumetric water content |
| I: illuminance | CO₂: carbon dioxide |
| PAR: Photosynthetically Active Radiation | |

(**) One sample consists of all the quantities measured and calculated by the data logger at the same instant of acquisition. For example, the model HD35EDW1N1TC measures two quantities and calculates five quantities (the derived humidity quantities) and one sample includes one temperature measure and six humidity measurements (the relative humidity measure plus the five derived quantities).

TAB. 9.5.2: Measurement characteristics (instrument in line with sensor)

Temperature - NTC10K Sensor	
For versions ...N...TC, ...TV and the model HD35EDW1NV	
<i>Sensor</i>	NTC 10 k Ω @ 25 °C
<i>Measurement range</i>	-40...+105 °C (-10...+60 °C for HD35EDW1NV)
<i>Resolution (of instrument)</i>	0.1 °C
<i>Accuracy</i>	± 0.3 °C in the range 0...+70 °C / ± 0.4 °C outside
<i>Stability</i>	0.1 °C/year
Temperature – Sensor integrated in RH module	
For versions ...TVI	
<i>Sensor</i>	Sensor integrated in humidity module
<i>Measurement range</i>	-40...+105 °C
<i>Resolution (of instrument)</i>	0.1 °C
<i>Accuracy</i>	± 0.2 °C in the range 0...+60 °C $\pm (0.2 - 0.05 * T)$ °C in the range T=-40...0 °C $\pm [0.2 + 0.032 * (T-60)]$ °C in the range T=+60...+105 °C
<i>Stability</i>	0.05 °C/year
Temperature - Pt100/Pt1000 Sensor	
For versions ...7P...TC	
<i>Sensor</i>	Pt100 / Pt1000 1/3 DIN thin film
<i>Measurement range</i>	-100...+350 °C max. for probes measuring only temperature (the measurement range can be limited by the operating temperature of the used probe) -40...+150 °C for T/RH combined probes HP3517ETC...
<i>Resolution (of instrument)</i>	0.1 °C
<i>Accuracy</i>	1/3 DIN
<i>Stability</i>	0.1 °C/year
Temperature - Thermocouple sensor	
For ...K...TC versions	
<i>Thermocouple type</i>	K, J, T, N, E The inputs are isolated from each other (60 V insulation)
<i>Measuring range</i>	type K: -200...+1370 °C type J: -100...+750 °C type T: -200...+400 °C type N: -200...+1300 °C type E: -200...+750 °C
<i>Resolution</i>	0.1 °C
<i>Accuracy (excluding probe error)</i>	type K: ± 0.1 °C (< 600 °C) type J: ± 0.1 °C ± 0.2 °C (> 600 °C) type T: ± 0.1 °C type N: ± 0.1 °C (< 600 °C) ± 0.2 °C (> 600 °C) type E: ± 0.1 °C (< 300 °C) ± 0.2 °C (> 300 °C)

Relative Humidity	
For versions ...TC, ...TV and the model HD35EDW1NV	
<i>Sensor</i>	Capacitive (the sensor can be calibrated by user)
<i>Measurement range</i>	0...100 %RH
<i>Resolution (of instrument)</i>	0.1 %
<i>Accuracy</i>	<i>standard</i> ± 2.5 % RH (0..90 % RH) / ± 3.5 % RH (remaining range) <i>with HP3517E...</i> ± 2 % RH (0..90 % RH) / ± 3 % RH (remaining range)
<i>Sensor operating temperature</i>	-20...+80 °C standard -40...+150 °C with HP3517E...probe
<i>Response time</i>	T ₉₀ < 20 s (air speed = 2 m/s, without filter)
<i>Temperature drift</i>	±2% over the whole operation temperature range
<i>Stability</i>	1%/year
Relative Humidity	
For versions ...TVI	
<i>Sensor</i>	Capacitive (the sensor can not be calibrated by user)
<i>Measurement range</i>	0...100 % RH
<i>Resolution (of instrument)</i>	0.1 %
<i>Accuracy</i>	± 1.8 % RH (0..80 %UR) ± [1.8 + 0.11 * (UR-80)] % RH (remaining range)
<i>Sensor operating temperature</i>	-40...+105 °C (R.H. max=[100-2*(T-80)] @ T=80...105 °C)
<i>Response time</i>	T ₆₃ < 4 s (air speed = 2 m/s, without filter)
<i>Temperature drift</i>	±2% over the whole operating temperature range
<i>Stability</i>	< 0.5%/year
Atmospheric pressure	
<i>Sensor</i>	Piezoresistive
<i>Measurement range</i>	300...1100 hPa
<i>Resolution (of instrument)</i>	0.1 hPa
<i>Accuracy</i>	± 0.5 hPa (800...1100 hPa) @ T=25°C ± 1 hPa (300...1100 hPa) @ T=0...50°C
<i>Stability</i>	1 hPa/anno
<i>Temperature drift</i>	±3 hPa tra -20...+60 °C
Solar radiation	
<i>Sensor</i>	Thermopile
<i>Measuring range</i>	0...2000 W/m ²
<i>Resolution (of the instrument)</i>	1 W/m ²
<i>Sensitivity</i>	Configurable in mV/(kW m ⁻²)
For the other characteristics, please refer to the data sheet of the chosen pyranometer. The instrument also displays the mV signal of the pyranometer.	
Rainfall quantity	
<i>Sensor</i>	Tipping bucket with NC or NO configurable contact
<i>Resolution (of the instrument)</i>	Configurable 0.1 – 0.2 – 0.5 mm/tipping
For the other characteristics, please refer to the data sheet of the chosen rain gauge.	
Leaf wetness	
<i>Sensor</i>	Capacitive
<i>Measuring range</i>	0...100% of leaf area wetness
<i>Resolution (of the instrument)</i>	0.1%
<i>Accuracy (@ 23 °C)</i>	± 5 %
<i>Sensor working temperature</i>	-30...+60 °C

Soil volumetric water content	
<i>Measuring principle</i>	Capacitive
<i>Measuring range</i>	0...100% VWC (Volumetric Water Content)
<i>Resolution (of the instrument)</i>	0.1%
<i>Accuracy</i>	± 3 % between 0 and 50% VWC (standard mineral soil up to 5 mS/cm)
<i>Sensor working temperature</i>	-40...+60 °C
Carbon Dioxide (CO₂)	
<i>Sensor</i>	Non-dispersive infrared rays (NDIR)
<i>Measuring range</i>	0...5000 ppm
<i>Resolution (instrument)</i>	1 ppm
<i>Accuracy</i>	± (50 ppm + 3% of measurement) @ 20 °C and 1013 hPa
<i>Operating temperature</i>	-20...60 °C
<i>Response time</i>	T ₉₀ < 120 s (air speed= 2 m/s)
<i>Stability</i>	5% of measurement/5 years
<i>Temperature drift</i>	1 ppm / °C
Illuminance	
<i>Sensor</i>	Photodiode
<i>Measuring range</i>	I: 0...20,000 lux / I2: 0...200,000 lux
<i>Resolution (instrument)</i>	I: 1 lux (0...2,000 lux), 10 lux (>2,000 lux) I2: 10 lux (0...20,000 lux), 100 lux (>20,000 lux)
<i>Spectral range</i>	In accordance with standard photopic curve V(λ)
<i>Spectral response</i>	See graph 1 on page 64
<i>a (temperature coefficient)</i>	<0.05% K
<i>f₆(T)</i>	
<i>Calibration uncertainty</i>	<4%
<i>f₁ (accordance with photopic response V(λ))</i>	<6%
<i>f₂ (response as cosine law)</i>	<3%
<i>f₃ (linearity)</i>	<1%
<i>f₄ (instrument reading error)</i>	<0.5%
<i>f₅ (fatigue)</i>	<0.5%
<i>Class</i>	B
<i>One year drift</i>	<1%
<i>Operating temperature</i>	0...50 °C
<i>Reference standard</i>	CIE n°69 – UNI 11142
PAR (Photosynthetically Active Radiation)	
<i>Sensor</i>	Photodiode
<i>Measuring range</i>	0...5000 μmol m ⁻² s ⁻¹
<i>Resolution (instrument)</i>	0.2 μmol m ⁻² s ⁻¹ (0...500 μmol m ⁻² s ⁻¹), 2 μmol m ⁻² s ⁻¹ (>500 μmol m ⁻² s ⁻¹)
<i>Spectral range</i>	400...700 nm
<i>Calibration uncertainty</i>	<5%
<i>f₂ (response as cosine law)</i>	<6%
<i>f₃ (linearity)</i>	<1%
<i>f₄ (instrument reading error)</i>	± 1 digit
<i>f₅ (fatigue)</i>	<0.5%
<i>One year drift</i>	<1%
<i>Operating temperature</i>	0...50 °C

Acceleration	
<i>Sensor</i>	Triaxial Accelerometer
<i>Measurement range</i>	0...16 g
<i>Resolution (of instrument)</i>	< 0.05 g (function of measured value)
<i>Accuracy</i>	< 0.1 g (function of measured value)

TAB. 9.5.3: Characteristics of terminal header inputs of HD35EDWH instrument:

Pt100 / Pt1000	
<i>Measuring range</i>	-200...+650 °C
<i>Resolution</i>	0.1 °C
<i>Accuracy</i>	± 0.1 °C (excluding probe error)
<i>Sensor coefficient</i>	$\alpha=0.00385 \text{ °C}^{-1}$
<i>Connection</i>	2, 3 or 4 wires
Thermocouple	
<i>Thermocouple type</i>	K, J, T, N, E. The inputs are not isolated, use thermocouples with isolated hot junction.
<i>Measuring range</i>	type K: -200...+1370 °C type J: -100...+750 °C type E: -200...+750 °C type T: -200...+400 °C type N: -200...+1300 °C
<i>Resolution</i>	0.1 °C
<i>Accuracy (excluding probe error)</i>	type K: ± 0.1 °C (< 600 °C) type E: ± 0.1 °C (< 300 °C) ± 0.2 °C (> 600 °C) ± 0.2 °C (> 300 °C) type N: ± 0.1 °C (< 600 °C) type J: ± 0.1 °C ± 0.2 °C (> 600 °C) type T: ± 0.1 °C
Input 0/4...20 mA	
<i>Shunt resistance</i>	Internal (50 Ω)
<i>Resolution</i>	16 bit
<i>Accuracy</i>	± 2 µA
Inputs 0...50 mV and 0...1 V / 0...10 V	
<i>Input Resistance</i>	100 MΩ
<i>Resolution</i>	16 bit
<i>Accuracy</i>	± 0.01% f.s.
Inputs for counting the switchings of a voltage-free contact	
<i>Switching frequency</i>	50 Hz max.
<i>Hold Time</i>	10 ms min.
Potentiometer input	
<i>Potentiometer</i>	Typically 10 kΩ
<i>Resolution</i>	16 bit
<i>Accuracy</i>	± 0.01% f.s.

10 HD35EDLM... DATA LOGGERS FOR WEATHER STATIONS

10.1 DESCRIPTION

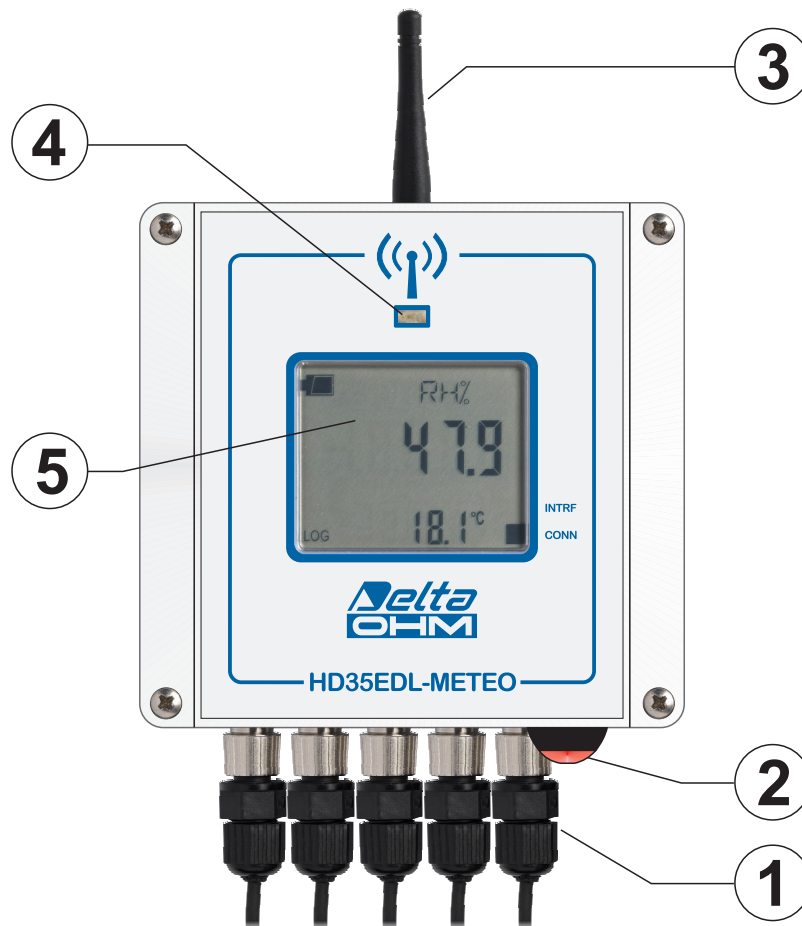

1. Five M12 connectors for:

- Relative humidity and temperature with NTC sensor combined probe or, alternatively, temperature only probe with NTC sensor.
- Pyranometer.
- Rain gauge.
- Cup anemometer.
- Wind direction vane.

Only one probe of each type can be connected. It is also possible to connect only some of the probes.

2. Connection button.

3. RF Antenna. The antenna is external for outdoor installation with protection shield against solar radiations; the antenna is internal for indoor installation.

4. Bicolor RF LED: blinks green if data transmission was successful; blinks red to indicate that data transmission has failed.

5. Custom LCD display.



10.2 MEASURING PROBES

Relative humidity and temperature: Models measuring temperature only (option **N**) use the probe **HP3507TC2** with NTC 10K Ω @ 25 °C sensor.

Models measuring relative humidity and temperature (option **1N**) use the combined probe **HP3517TC2** with NTC 10K Ω @ 25 °C temperature sensor. Alternatively, to the same input can be connected the temperature only probe **HP3507TC2**.

The outdoor installation of the probe requires HD9007A-1 or HD9007A-2 protection against solar radiations. **Replacement of the probe requires recalibration of the instrument in line with the new probe.**

Atmospheric pressure: If available (option **4b**), the sensor is inside the instrument.

Rainfall quantity: For models measuring rainfall quantity (option **P**), the rain gauges HD2013 (area 400 cm²), HD2013R (area 400 cm², with heating), HD2015 (area 200 cm²) and HD2015R (area 200 cm², with heating) are available.

Solar radiation: To the models provided with input for the solar radiation sensor (option **R**), the pyranometers LP PYRA 02, LP PYRA 03, LP SILICON-PYRA 04, etc. with mV output signal can be connected. In addition to the solar radiation in W/m², the instrument also records the pyranometer output signal in mV.

Wind speed and direction: Models measuring wind speed (option **W**) and direction (option **D**) use the cup anemometer **HD54.3** and the wind vane **HD54.D**.

The cup anemometer and the wind vane require a minimum threshold speed (typically 1÷1.5 m/s) to provide reliable indications. If the speed falls below the minimum threshold, the direction indication is frozen at the last value measured, while the speed indication is blocked to the threshold value or to zero (the behaviour is configurable by using the HD35AP-S software).

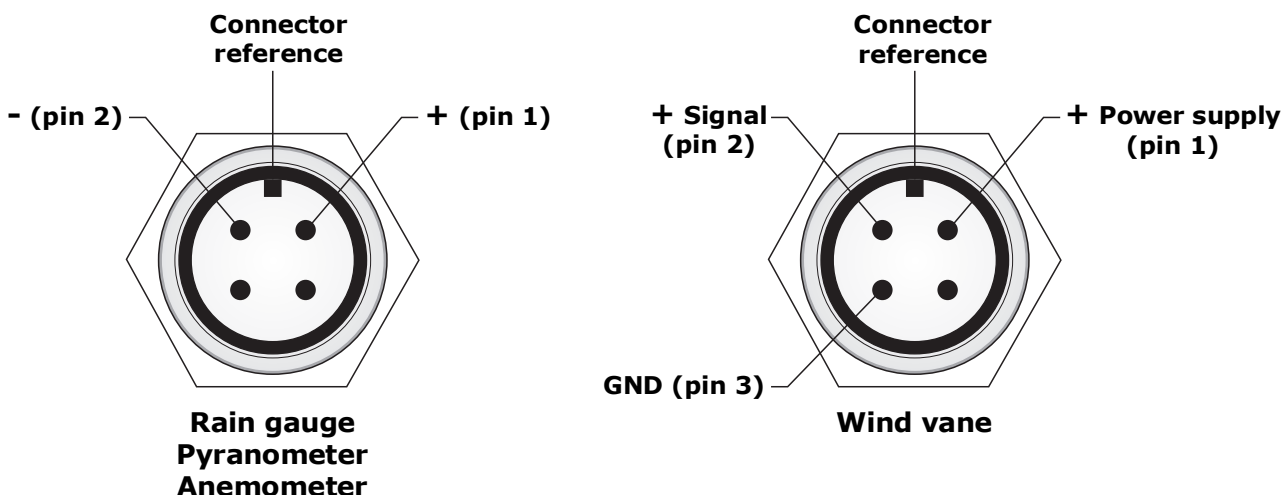

Fig. 10.2.1: data logger connectors viewed from outside

10.3 INSTALLATION OF HOUSING

The housing can be fixed to a wall or, for outdoor installations, to a 40 mm diameter mast by means of HD2003.77/40 clamping.

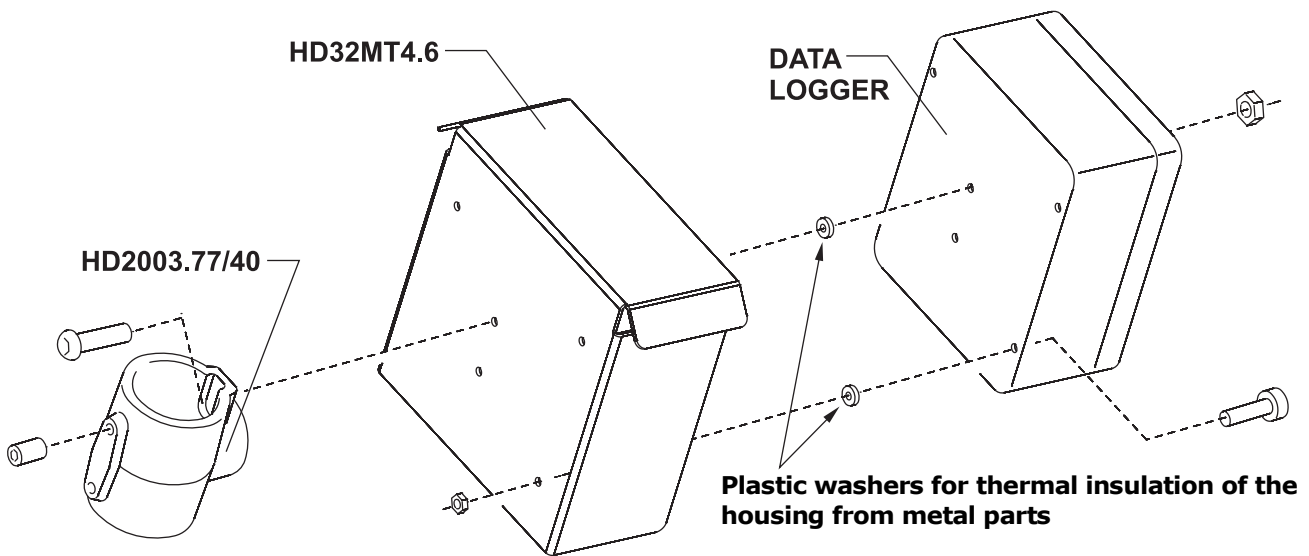

Fig. 10.3.1: installation of housing

For outdoor installations, use the optional protection shield against solar radiations (**HD32MT4.6**).

Data loggers supplied with clamping already mounted on the back of the housing are equipped with protection devices against over-voltages connected to the clamping. For a correct operation of the protecting devices, the yellow/green wire with fast-on connector connected to the clamping should be connected to ground.

The outdoor installation of the combined temperature and relative humidity probe requires HD9007A-1 or HD9007A-2 protection against solar radiations.

10.4 CONNECTION TO THE WIRELESS NETWORK

The device can be connected and disconnected to/from the wireless network **by pressing for 5 seconds** the connection button.

If the device is disconnected, by pressing for 5 seconds the connection button the buzzer emits a beep and the RF LED blinks green for 1 second to indicate the start of the connection procedure. If the device belongs to a wireless network and the base unit is reachable, after connection the buzzer emits a second beep and the RF LED blinks green during data transmission. If the device doesn't belong to a wireless network and the base unit is not reachable, the second beep of the buzzer is not emitted and the RF LED will blink red.

If the device is connected, by pressing for 5 seconds the connection button the buzzer emits a beep, the RF LED blinks red for 1 second and the device is disconnected.

The connection status is signaled also by the connection icon on the display (see figure 3.6 on page 10):

- the icon is steady on if the data logger is connected;
- the icon blinks if the data logger is trying to connect (the icon will be steady on after connection or will go on blinking if the base unit cannot be reached or the data logger doesn't belong to a wireless network);
- the icon is off if the data logger is not connected.

PING function:

In the devices connected to a wireless network it is possible to check if the base unit can be reached by briefly pressing the connection button: if the RF LED blinks green, it means that the base unit is reachable, otherwise the RF LED blinks red.

10.5 DISPLAY

Through HD35AP-S software, you can select the measurement to be displayed on the main line of the display or set the automatic alternation of measured quantities. Information on the connection status, logging (in progress/disabled), and battery charge level are shown. The secondary line displays temperature (if measured by the model).

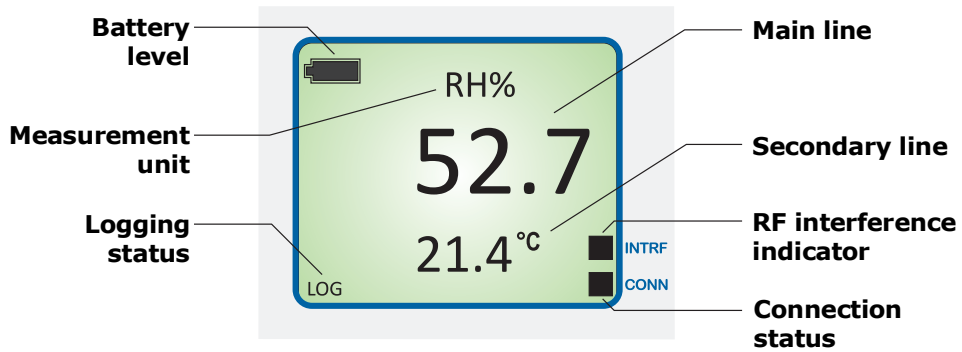

Fig. 10.5.1: custom LCD

10.6 TECHNICAL CHARACTERISTICS OF DATA LOGGERS FOR WEATHER STATIONS

<i>Transmission frequency</i>	868 MHz, 902-928 MHz or 915.9-929.7 MHz according to the model
<i>Antenna</i>	External for outdoor installation with protection shield against solar radiations. Internal for indoor installation.
<i>Transmission range</i>	In open field: 300 m (E, J)/ 180 m (U) with internal antenna towards base unit (except HD35APD) and repeaters. 180 m (E, U) with internal antenna towards base unit HD35APD. > 500 m (E, J, U) with external antenna towards base unit (except HD35APD) and repeaters. 180 m (E, U) with external antenna towards base unit HD35APD. (could be reduced in presence of obstacles or adverse atmospheric conditions)
<i>Measuring interval (*)</i>	1, 2, 5, 10, 15, 30 s / 1, 2, 5, 10, 15, 30, 60 min
<i>Logging and transmission interval (*)</i>	1, 2, 5, 10, 15, 30 s / 1, 2, 5, 10, 15, 30, 60 min
<i>Internal memory</i>	Circular management or stop logging if memory is full. Number of samples: from 28,000 to 58,000 depending on the number of detected quantities.
<i>Alarm</i>	Acoustic through internal buzzer
<i>Display</i>	Custom LCD
<i>Buttons</i>	Watertight push-button for connection / PING (for testing RF), located at the bottom of the housing.
<i>LED indicators</i>	RF communication status (bicolor LED)
<i>Power supply</i>	Non rechargeable lithium thionyl chloride (Li-SOCl ₂) internal battery, 3.6 V, 8400 mAh, C format, 2-pole Molex 5264 connector.
<i>Battery life</i> <i>(without repeaters, direct communication with HD35AP...)</i>	4 years typical (with 5 s measurement interval and 30 s logging interval)
<i>Operating temperature and humidity</i>	-20...+70 °C / 0...100 %RH
<i>Dimensions</i>	See dimensional drawing
<i>Connectors for external probes with cable</i>	M12 connectors
<i>Weight</i>	600 g approx. (including battery and fixing clamping)
<i>Housing</i>	Polycarbonate
<i>Protection Degree</i>	IP 67
<i>Installation</i>	Fixing to a 40mm diameter mast through the clamping HD2003.77/40 (optional) . Protection shield against solar radiations HD32MT4.6 (optional) for outdoor installation.

(*) Some models that measure many quantities may have a minimum interval higher than 1 second.

TAB. 10.6.1: Measurement characteristics (instrument in line with sensor)

Temperature	
<i>Sensor</i>	NTC 10 kΩ @ 25 °C
<i>Measurement range</i>	-40...+105 °C
<i>Resolution (of instrument)</i>	0.1 °C
<i>Accuracy</i>	± 0.3 °C in the range 0...+70 °C / ± 0.4 °C outside
<i>Stability</i>	0.1 °C/year
Relative Humidity	
<i>Sensor</i>	Capacitive
<i>Measurement range</i>	0...100 %RH
<i>Resolution (of instrument)</i>	0.1 %
<i>Accuracy</i>	± 2.5 %RH (0..90 % RH) / ± 3.5 % RH (remaining range)
<i>Sensor operating temperature</i>	-20...+80 °C
<i>Response time</i>	T ₉₀ < 20 s (air speed = 2 m/s, without filter)
<i>Temperature drift</i>	±2% over the whole operation temperature range
<i>Stability</i>	1%/year
Calculated quantities	Dew Point
Atmospheric pressure	
<i>Sensor</i>	Piezoresistive
<i>Measurement range</i>	300...1100 hPa
<i>Resolution (of instrument)</i>	0.1 hPa
<i>Accuracy</i>	± 0.5 hPa (800...1100 hPa) @ T=25°C ± 1 hPa (300...1100 hPa) @ T=0...50°C
<i>Stability</i>	1 hPa/anno
<i>Temperature drift</i>	±3 hPa tra -20...+60 °C
Solar radiation	
<i>Sensor</i>	Thermopile
<i>Measuring range</i>	0...2000 W/m ²
<i>Resolution (of the instrument)</i>	1 W/m ²
<i>Sensitivity</i>	Configurable in mV/(kW m ⁻²)
Calculated quantities	Daily solar radiation (Wh/m ²)
For the other characteristics, please refer to the data sheet of the chosen pyranometer.	
Rainfall quantity	
<i>Sensor</i>	Tipping bucket with NC or NO configurable contact
<i>Resolution (of the instrument)</i>	Configurable 0.1 – 0.2 – 0.5 mm/tipping
Calculated quantities	Rainfall rate in mm/h. Statistical values: rainfall quantity in the last hour, day, week, month and year.
For the other characteristics, please refer to the data sheet of the chosen rain gauge: HD2013 (area 400 cm ²) or HD2015 (area 200 cm ²).	
Wind direction – Characteristics of the HD54.D vane	
<i>Sensor</i>	continuous rotation potentiometric vane
<i>Measuring range</i>	0...359.9°
<i>Resolution (of the instrument)</i>	0.1°
<i>Accuracy</i>	< 1%
<i>Dead band</i>	4° typical, 8° max.
<i>Threshold</i>	1 m/s

Wind speed – Characteristics of the HD54.3 cup anemometer	
<i>Sensor</i>	Passive 3-cup anemometer
<i>Measuring range</i>	1...65 m/s
<i>Resolution (of the instrument)</i>	0.1 m/s
<i>Accuracy</i>	± 0.14 m/s @ 10 m/s installed on a flat terrain site
<i>Offset</i>	0.35 m/s
<i>Gain</i>	0.765 m s ⁻¹ /Hz
<i>Distance constant (63% recovery)</i>	2.55 m @ 5 m/s / 2.56 m @ 10 m/s (ASTM D 5096-02)
Calculated quantities	<p>Felt air temperature as a function of the wind speed: Wind Chill index (only if the logger measures also temperature).</p> <p>Wind gust: maximum wind speed obtained from the 3 seconds averages of the measurements acquired once per second.</p>

11 HD35ED-ALM REMOTE ALARM DEVICE

11.1 DESCRIPTION

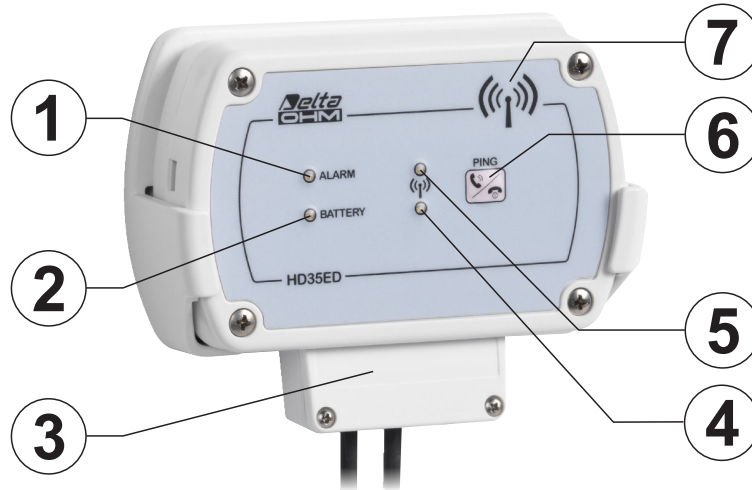

1. ALARM LED: red color, it blinks to signal alarm conditions.
2. BATTERY LED: green color, it indicates the internal battery charge level. As the battery runs low, the LED blinks with a lower and lower frequency (the blink period increases of 1 second for each 10% decrease of the battery charge).
3. Relay outputs. The connection terminals are protected by a cover.
4. Green RF LED: it blinks if RF transmission was successful.
5. Red RF LED: it blinks to indicate that RF transmission has failed
6. Connection / PING (for testing RF) button.
7. Internal RF antenna.

11.2 CONNECTION

Two bistable relays with potential-free contact are available. In order for relays to be activated in case of an alarm, alarm conditions should be associated to relays activation through the HD35AP-S software (see section **Alarm settings** in the software instructions). Contacts arrangement is shown in the following figure.

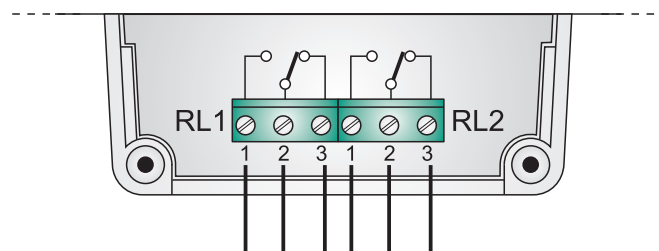

Fig. 11.2.1: relays in HD35ED-ALM alarm device

11.3 CONNECTION TO THE WIRELESS NETWORK

The device can be connected and disconnected to/from the wireless network by **pressing for 5 seconds** the connection button on the front panel (see step 6 of paragraph 7.1).

If the device is disconnected, by pressing the connection button for 5 seconds the buzzer emits a beep and the green LED activates for one second to indicate the start of the connection procedure. If the device belongs to a wireless network and the base unit is reachable, once connected, the buzzer emits a second beep and the green RF LED will blink during data transmission. If the device doesn't belong to a wireless network or the base unit cannot be reached, the second beep of the buzzer is not emitted and the red RF LED will blink.

If the device is connected, by pressing the connection button for 5 seconds the buzzer emits a beep, the red RF LED activates for one second and the device is disconnected.

PING function:

In the devices connected to a wireless network it is possible to check if the base unit can be reached by briefly pressing the connection button: if the green RF LED is blinking, it means that the base unit is reachable, otherwise it will be the red RF LED to blink.

11.4 TECHNICAL CHARACTERISTICS OF THE ALARM DEVICE

<i>Transmission Frequency</i>	868 MHz, 902-928 MHz or 915.9-929.7 MHz according to the model
<i>Antenna</i>	Internal
<i>Transmission range</i>	In open field: 300 m (E, J)/ 180 m (U) towards base unit (except HD35APD...) and repeaters. 180 m (E, U) towards base unit HD35APD. (could be reduced if obstacles or adverse weather conditions are present)
<i>Keyboard</i>	Connection / PING (for testing RF) button
<i>LED indicators</i>	Alarm condition, battery charge level, RF communication status.
<i>Relays</i>	2 bistable relays with potential-free contact Contact: max 1A @ 30Vdc resistive load
<i>Buzzer</i>	Sounds cyclically when an alarm condition occurs: 1 single beep indicates that relay 1 is active 2 beeps in rapid succession indicate that relay 2 is active 3 beeps in rapid succession indicate that both relays are active
<i>Power supply</i>	Non rechargeable lithium thionyl chloride (Li-SOCl ₂) internal battery, 3.6 V, AA format, 2-pole Molex 5264 connector.
<i>Battery life</i>	1 year in typical operating conditions The effective life depends on how often the alarm condition is generated
<i>Operating temperature and humidity</i>	-10...+70 °C / 0...85 %RH non condensing
<i>Dimensions</i>	See dimensional drawing
<i>Weight</i>	200 g approx. (battery included)
<i>Housing</i>	LURAN® S 777K
<i>Installation</i>	Wall mount (supplied) for removable installation or flanges (optional) for fixed installation

12 MODBUS

In MODBUS communication the base unit works as a multiplexer (i.e., as an interface) to address MODBUS commands from PC/PLC to wireless network devices. That means that the address of a wireless device (for ex. a data logger) which is not physically connected to the RS485 (MODBUS-RTU) or LAN (MODBUS TCP/IP) network can be added to the MODBUS command: the base unit, physically connected to the RS485 or LAN network, will intercept the command and will send it to the interested wireless device. The wireless device will execute the command and reply to the base unit; this will send back the reply to the PC/PLC. In order for a wireless device to be addressed successfully, devices with the same MODBUS address as that of wireless devices should not be present in RS485 or LAN network.

The device general information can be read through the function code **0x2B/0x0E**. It consists of:

- Manufacturer (Delta OHM)
- Model
- Firmware version

The complete list of MODBUS registers is shown below. According to the device model, some of the listed registers could not be present if not significant for that particular model (for ex., CO₂ measurement will not be available if it is not measured by the data logger). If you try to read a register that is not present, the instrument returns the fixed value 32767. In case of doubt on the registers actually available in a particular model, use the function " *Download the list of MODBUS registers of the device* " included in the *Settings* sections of HD35AP-S software (see software instructions).

The following conventions have been used in the tables:

- **AP** = base unit, **ED** = data logger, **RE** = repeater, **AL** = alarm module
AP, ED, RE, AL columns indicate the device where the parameter is available.
- Type: **b** = bit, **B** = 8 bits (Byte), **W** = 16 bits without sign (Word), **SW** = 16 bits with sign
- **(x10)** = decimal value expressed as an integer (e.g., if the content of the register is 184, the value is to be intended as 18,4).
- **(x100)** = centesimal value expressed as an integer (e.g., if the content of the register is 500, the value is to be intended as 5,00).

The commands for requesting units of measurement return an index according to the correspondence indicated in the table below:

TAB. 12.1: indexes of the units of measurement

Index	Unit of meas.	Index	Unit of meas.	Index	Unit of meas.	Index	Unit of meas.	Index	Unit of meas.
0	°C	10	atm	20	mph	30	mA	40	Counts
1	°F	11	mmHg	21	knot	31	ppm	41	mm/h
2	%RH	12	mmH ₂ O	22	W/m ²	32	Hz	42	inch/h
3	g/m ³	13	inchHg	23	μW/cm ²	33	%	43	counts/h
4	g/kg	14	inchH ₂ O	24	Wh/m ²	34	degrees	44	mW/m ²
5	mbar	15	kgf/cm ²	25	kWh/m ²	35	lux	45	m
6	bar	16	PSI	26	J/m ²	36	m ² /s	46	s
7	Pa	17	m/s	27	μJ/cm ²	37	g ^(*)	47	μW/lumen
8	hPa	18	km/h	28	V	38	mm	255	Not defined
9	kPa	19	ft/s	29	mV	39	inch		

(*) Gravity acceleration

TAB. 12.2: Discrete Inputs – Read-only parameters

Address	Type	Discrete Input description	AP	ED	RE	AL
0	b	If 1, the device is subjected to RF interference due to the transmission of more covering repeaters.		✓	✓	✓
1	b	If 1, the last transmitted measurement packet has been lost		✓		
2	b	Flag PENDING_CONF. If 1, there is a pending configuration change request.	✓	✓	✓	✓
3	b	If 1, there are more devices with the same Modbus address in the network. The conflict must be solved.	✓			
4	b	If 1, there is a RF scheduling problem. The set transmission interval is too short.		✓		✓
5	b	If 1, a network migration to another RF channel is in progress.	✓	✓	✓	✓
6	b	If 1, the device supports a rechargeable battery.	✓		✓	

TAB. 12.3: Coils – Read/Write parameters

Address	Type	Coil description	AP	ED	RE	AL
0	b	Waiting time after Modbus transmission: 0= immediate reception, 1=waiting time for 3.5 characters	✓			
1	b	Logging status: 0=active, 1=inactive		✓		
2	b	Logging mode: 0=non cyclic, 1=cyclic		✓		
3	b	Set 1 to delete the device logging memory. Bit zeroing is automatic.	✓	✓		
4	b	Buzzer activation (for AP and ED) or relays activation (for AL) in case of measurement alarm: 0=no, 1=yes	✓	✓		✓
5	b	If 1, there are unsaved device parameters in the flash memory. Set 0 to force storage.	✓			
6	b	If 1, there is a pending RF rescheduling (RF transmission sequence of devices). Set 0 to force rescheduling.	✓			
7	b	Flag CMD_FAILURE. If 1, at least a command sent to the device has failed. Set 0 to reinitialize the flag.	✓	✓	✓	✓
8	b	Buzzer activation in case of RF alarm: 0=no, 1=Yes	✓			
9	b	Protection of configuration with password: 0=no, 1=yes Changing the parameter requires the Administrator password (see Holding Register 10036).	✓			
13	b	Set 1 to reinitialize the counter in HD35EDH model with counter input. Bit zeroing is automatic.		✓		
14	b	If 1, some device parameters in the base unit could be not updated. Set 0 to force the update.		✓	✓	✓
15	b	CO ₂ sensor autocalibration: 0=OFF, 1=ON		✓		
16	b	Relay #1 activation in case of measurement alarm: 0=no, 1=yes				✓
17	b	Relay #1 activation in case of RF alarm : 0=no, 1=yes				✓
18	b	If 1, relay #1 is always active as long as the alarm persists				✓
19	b	Relay #2 activation in case of measurement alarm: 0=no, 1=yes				✓
20	b	Relay #2 activation in case of RF alarm : 0=no, 1=yes				✓
21	b	If 1, relay #2 is always active as long as the alarm persists				✓

TAB. 12.4: Input Registers – Read-only parameters

Address	Type	Input Register description	AP	ED	RE	AL
Measured values and status of measurement alarms						
0	SW	TEMPERATURE with NTC10K sensor of channel 1 in the set measurement unit (x10).		✓		
1	B	Alarm for temperature with NTC10K sensor of channel 1: 0=OFF, 1= lower threshold alarm, 2= higher threshold alarm		✓		

Address	Type	Input Register description	AP	ED	RE	AL
2	SW	RELATIVE HUMIDITY in % (x10). Only for models ...TC and ...TV.		✓		
3	B	Relative humidity alarm: 0=OFF, 1=lower threshold alarm, 2=higher threshold alarm. Only for models ...TC and ...TV.		✓		
4	SW	DEW POINT in the set measurement unit (x10).		✓		
5	B	Dew Point alarm: 0=OFF, 1=lower threshold alarm, 2=higher threshold alarm.		✓		
6	SW	PARTIAL VAPOR PRESSURE in hPa (x100).		✓		
7	B	Partial vapor pressure alarm: 0=OFF, 1=lower threshold alarm, 2=higher threshold alarm.		✓		
8	SW	MIXING RATIO in g/Kg (x10).		✓		
9	B	Mixing ratio alarm: 0=OFF, 1=lower threshold alarm, 2=higher threshold alarm.		✓		
10	SW	ABSOLUTE HUMIDITY in g/m ³ (x10).		✓		
11	B	Absolute humidity alarm : 0=OFF, 1=lower threshold alarm, 2=higher threshold alarm.		✓		
12	SW	WET BULB TEMPERATURE in the set measurement unit (x10).		✓		
13	B	Wet bulb temperature alarm: 0=OFF, 1=lower threshold alarm, 2=higher threshold alarm.		✓		
16	SW	TEMPERATURE with NTC10K sensor of channel 2 in the set measurement unit (x10).		✓		
17	B	Alarm for temperature with NTC10K sensor of channel 2: 0=OFF, 1=lower threshold alarm, 2=higher threshold alarm.		✓		
18	SW	SOLAR RADIATION in W/m ² .		✓		
19	B	Alarm for solar radiation: 0=OFF, 1=lower threshold alarm, 2=higher threshold alarm.		✓		
20	SW	ILLUMINANCE in lux (low range, models HD35ED...I...).		✓		
21	B	Illuminance (low range, models HD35ED...I...) alarm: 0=OFF, 1=lower threshold alarm, 2=higher threshold alarm.		✓		
22	SW	CO in ppm.		✓		
23	B	CO alarm: 0=OFF, 1=lower threshold alarm, 2=higher threshold alarm.		✓		
24	SW	ATMOSPHERIC PRESSURE in the set measurement unit (the multiplier depends on the set unit).		✓		
25	B	Atmospheric pressure alarm: 0=OFF, 1=lower threshold alarm, 2=higher threshold alarm.		✓		
30	SW	DAILY SOLAR RADIATION in Wh/m ² .		✓		
31	B	Alarm for daily solar radiation: 0=OFF, 1=lower threshold alarm, 2=higher threshold alarm.		✓		
32	SW	CO₂ in ppm.		✓		
33	B	CO ₂ alarm: 0=OFF, 1=lower threshold alarm, 2=higher threshold alarm.		✓		
46	SW	TEMPERATURE with sensor integrated in RH module in the set measurement unit (x10). Only for models ...TVI and ...AB.		✓		
47	B	Alarm for temperature with sensor integrated in RH module: 0=OFF, 1=lower threshold alarm, 2=higher threshold alarm. Only for models ...TVI and ...AB.		✓		
48	SW	RELATIVE HUMIDITY in % (x10). Only for models ...TVI and ...AB.		✓		
49	B	Relative humidity alarm: 0=OFF, 1=lower threshold alarm, 2=higher threshold alarm. Only for models...TVI and ...AB.		✓		
50	SW	TEMPERATURE with NTC10K sensor of channel 3 in the set measurement unit (x10).		✓		

Address	Type	Input Register description	AP	ED	RE	AL
51	B	Alarm for temperature with NTC10K sensor of channel 3: 0=OFF, 1=lower threshold alarm, 2=higher threshold alarm.		✓		
52	SW	WIND SPEED in the set measurement unit (the multiplier depends on the set unit).		✓		
53	B	Wind speed alarm: 0=OFF, 1=lower threshold alarm, 2=higher threshold alarm.		✓		
54	SW	WIND DIRECTION in degrees (x10).		✓		
55	B	Wind direction alarm: 0=OFF, 1=lower threshold alarm, 2=higher threshold alarm.		✓		
56	SW	DIFFERENTIAL PRESSURE for the range r3 in the set measurement unit (the multiplier depends on the set unit).		✓		
57	B	Differential pressure alarm for the range r3: 0=OFF, 1=lower threshold alarm, 2=higher threshold alarm.		✓		
58	SW	WIND CHILL in the set measurement unit (x10).		✓		
59	B	Wind chill alarm: 0=OFF, 1=lower threshold alarm, 2=higher threshold alarm.		✓		
60	SW	DIFFERENTIAL PRESSURE for ranges r1 and r2 in the set measurement unit (the multiplier depends on the set unit).		✓		
61	B	Differential pressure alarm for ranges r1 and r2: 0=OFF, 1=lower threshold alarm, 2=higher threshold alarm.		✓		
62	SW	DIFFERENTIAL PRESSURE for the range r4 in the set measurement unit (the multiplier depends on the set unit).		✓		
63	B	Differential pressure alarm for the range r4: 0=OFF, 1=lower threshold alarm, 2=higher threshold alarm.		✓		
64	SW	TEMPERATURE with Pt100 sensor of HP3517E... probe in the set measurement unit (x10).		✓		
65	B	Alarm for temperature with Pt100 sensor of HP3517E... probe: 0=OFF, 1=lower threshold alarm, 2=higher threshold alarm.		✓		
66	SW	PYRANOMETER OUTPUT in mV (x100).		✓		
67	B	Pyranometer output alarm: 0=OFF, 1=lower threshold alarm, 2=higher threshold alarm.		✓		
68	SW	UVA IRRADIANCE in mW/m ² .		✓		
69	B	UVA irradiance alarm: 0=OFF, 1=lower threshold alarm, 2=higher threshold alarm.		✓		
70	SW	PROPORTION OF UV PRESENT in μW/lumen.		✓		
71	B	Proportion of UV present alarm: 0=OFF, 1=lower threshold alarm, 2=higher threshold alarm.		✓		
80	SW	ILLUMINANCE in lux (high range, models HD35ED...I2...).		✓		
81	B	Illuminance (high range, models HD35ED...I2...) alarm: 0=OFF, 1=lower threshold alarm, 2=higher threshold alarm.		✓		

Address	Type	Input Register description	AP	ED	RE	AL
Measured values and status of measurement alarms for configurable inputs						
1000 + 200x(N-1)	SW	TEMPERATURE with 2-wire Pt100 sensor of channel N in the set measurement unit (x10).		✓		
1001 + 200x(N-1)	B	Alarm for temperature with 2-wire Pt100 sensor of channel N : 0=OFF, 1=lower threshold alarm, 2=higher threshold alarm.		✓		
1002 + 200x(N-1)	SW	TEMPERATURE with 3-wire Pt100 sensor of channel N in the set measurement unit (x10).		✓		
1003 + 200x(N-1)	B	Alarm for temperature with 3-wire Pt100 sensor of channel N : 0=OFF, 1=lower threshold alarm, 2=higher threshold alarm.		✓		
1004 + 200x(N-1)	SW	TEMPERATURE with 4-wire Pt100 sensor of channel N in the set measurement unit (x10).		✓		
1005 + 200x(N-1)	B	Alarm for temperature with 4-wire Pt100 sensor of channel N : 0=OFF, 1=lower threshold alarm, 2=higher threshold alarm.		✓		
1006 + 200x(N-1)	SW	TEMPERATURE with 2-wire Pt1000 sensor of channel N in the set measurement unit (x10).		✓		
1007 + 200x(N-1)	B	Alarm for temperature with 2-wire Pt1000 sensor of channel N : 0=OFF, 1=lower threshold alarm, 2=higher threshold alarm.		✓		
1008 + 200x(N-1)	SW	TEMPERATURE with 3-wire Pt1000 sensor of channel N in the set measurement unit (x10).		✓		
1009 + 200x(N-1)	B	Alarm for temperature with 3-wire Pt1000 sensor of channel N : 0=OFF, 1=lower threshold alarm, 2=higher threshold alarm.		✓		
1010 + 200x(N-1)	SW	TEMPERATURE with 4-wire Pt1000 sensor of channel N in the set measurement unit (x10).		✓		
1011 + 200x(N-1)	B	Alarm for temperature with 4-wire Pt1000 sensor of channel N : 0=OFF, 1=lower threshold alarm, 2=higher threshold alarm.		✓		
1012 + 200x(N-1)	SW	TEMPERATURE with TC_K sensor of channel N in the set measurement unit (x10).		✓		
1013 + 200x(N-1)	B	Alarm for temperature with TC_K sensor of channel N : 0=OFF, 1=lower threshold alarm, 2=higher threshold alarm.		✓		
1014 + 200x(N-1)	SW	TEMPERATURE with TC_J sensor of channel N in the set measurement unit (x10).		✓		
1015 + 200x(N-1)	B	Alarm for temperature with TC_J sensor of channel N : 0=OFF, 1=lower threshold alarm, 2=higher threshold alarm.		✓		
1016 + 200x(N-1)	SW	TEMPERATURE WITH TC_T sensor of channel N in the set measurement unit (x10).		✓		
1017 + 200x(N-1)	B	Alarm for temperature with TC_T sensor of channel N : 0=OFF, 1=lower threshold alarm, 2=higher threshold alarm.		✓		
1018 + 200x(N-1)	SW	TEMPERATURE with TC_N sensor of channel N in the set measurement unit (x10).		✓		
1019 + 200x(N-1)	B	Alarm for temperature with TC_N sensor of channel N : 0=OFF, 1=lower threshold alarm, 2=higher threshold alarm.		✓		
1026 + 200x(N-1)	SW	TEMPERATURE with TC_E sensor of channel N in the set measurement unit (x10).		✓		
1027 + 200x(N-1)	B	Alarm for temperature with TC_E sensor of channel N : 0=OFF, 1=lower threshold alarm, 2=higher threshold alarm.		✓		
1028 + 200x(N-1)	SW	Input value in mV of channel N (x10). Only if channel N is configured as 0...1 V input (HD35EDH).		✓		
1029 + 200x(N-1)	B	Alarm for channel N if the channel is configured as 0...1 V input (HD35EDH): 0=OFF, 1=lower threshold alarm, 2=higher threshold alarm.		✓		
1030 + 200x(N-1)	SW	Input value in mV of channel N (x100). Only if channel N is configured as 0...50 mV input (HD35EDH).		✓		
1031 + 200x(N-1)	B	Alarm for channel N if the channel is configured as 0...50 mV input (HD35EDH): 0=OFF, 1=lower threshold alarm, 2=higher threshold alarm.		✓		
1032 + 200x(N-1)	SW	Input value in mA of channel N (x100). Only if channel N is configured as 4...20 mA input (HD35EDH).		✓		

Address	Type	Input Register description	AP	ED	RE	AL
1033 + 200 x (N-1)	B	Alarm for channel N if the channel is configured as 4...20 mA input (HD35EDH): 0=OFF, 1=lower threshold alarm, 2=higher threshold alarm.		✓		
1034 + 200 x (N-1)	SW	Position of potentiometer in % of channel N . Only if channel N is configured as potentiometric input (HD35EDH).		✓		
1035 + 200 x (N-1)	B	Alarm for channel N if the channel is configured as potentiometric input (HD35EDH): 0=OFF, 1=lower threshold alarm, 2=higher threshold alarm.		✓		
1036 + 200 x (N-1)	SW	Value of quantity associated to channel N if the channel is configured as 0...1 V input (HD35EDH).		✓		
1037 + 200 x (N-1)	B	Alarm for quantity associated to channel N if the channel is configured as 0...1 V input (HD35EDH): 0=OFF, 1=lower threshold alarm, 2=higher threshold alarm.		✓		
1038 + 200 x (N-1)	SW	Value of quantity associated to channel N if the channel is configured as 0...50 mV input (HD35EDH).		✓		
1039 + 200 x (N-1)	B	Alarm for quantity associated to channel N if the channel is configured as 0...50 mV input (HD35EDH): 0=OFF, 1=lower threshold alarm, 2=higher threshold alarm.		✓		
1040 + 200 x (N-1)	SW	Value of quantity associated to channel N if the channel is configured as 4...20 mA input (HD35EDH).		✓		
1041 + 200 x (N-1)	B	Alarm for quantity associated to channel N if the channel is configured as 4...20 mA input (HD35EDH): 0=OFF, 1=lower threshold alarm, 2=higher threshold alarm.		✓		
1042 + 200 x (N-1)	SW	Value of quantity associated to channel N if the channel is configured as potentiometric input (HD35EDH).		✓		
1043 + 200 x (N-1)	B	Alarm for quantity associated to channel N if the channel is configured as potentiometric input (HD35EDH): 0=OFF, 1=lower threshold alarm, 2=higher threshold alarm.		✓		
4000 to 4001	SW	Number of counts . Only if the channel is configured as counter (HD35EDH).		✓		
4002 to 4003	B	Alarm for number of counts if the channel is configured as counter (HD35EDH): 0=OFF, 1=lower threshold alarm, 2=higher threshold alarm.		✓		
da 4004 a 4005	SW	Value of quantity associated to the channel if the channel is configured as counter (HD35EDH).		✓		
4006 to 4007	B	Alarm for quantity associated to the channel if the channel is configured as counter (HD35EDH): 0=OFF, 1=lower threshold alarm, 2=higher threshold alarm.		✓		
Measurement units and resolution						
5000	W	Unit of measurement for TEMPERATURE with NTC10K sensor of channel 1 : 0=°C, 1=°F.		✓		
5004	W	DEW POINT measurement unit: 0=°C, 1=°F.		✓		
5012	W	WET BULB TEMPERATURE measurement unit: 0=°C, 1=°F.		✓		
5016	W	Unit of measurement for TEMPERATURE with NTC10K sensor of channel 2 : 0=°C, 1=°F.		✓		
5021	SW	ILLUMINANCE resolution: -2=100, -1=10, 0=1		✓		
5024	W	ATMOSPHERIC PRESSURE measurement unit: see TAB 10.1		✓		
5025	SW	ATMOSPHERIC PRESSURE resolution: ..., -2=100, -1=10, 0=1, 1=0.1, 2=0.01, ...		✓		
5046	W	Unit of measurement for TEMPERATURE with sensor integrated in RH module: 0=°C, 1=°F. Only for models ...TVI and ...AB .		✓		
5050	W	Unit of measurement for TEMPERATURE with NTC10K sensor of channel 3 : 0=°C, 1=°F.		✓		
5052	W	WIND SPEED measurement unit: see TAB 10.1		✓		

Address	Type	Input Register description	AP	ED	RE	AL
5053	SW	WIND SPEED resolution: ..., -2=100, -1=10, 0=1, 1=0.1, 2=0.01, ...		✓		
5056	W	DIFFERENTIAL PRESSURE measurement unit for range r3 : see TAB 10.1		✓		
5057	SW	DIFFERENTIAL PRESSURE resolution for range r3 : ..., -2=100, -1=10, 0=1, 1=0.1, 2=0.01, ...		✓		
5058	W	WIND CHILL measurement unit: 0=°C, 1=°F.		✓		
5060	W	DIFFERENTIAL PRESSURE measurement unit for ranges r1 and r2 : see TAB 10.1		✓		
5061	SW	DIFFERENTIAL PRESSURE resolution for ranges r1 and r2 : ..., -2=100, -1=10, 0=1, 1=0.1, 2=0.01, ...		✓		
5062	W	DIFFERENTIAL PRESSURE measurement unit for range r4 : see TAB 10.1		✓		
5063	SW	DIFFERENTIAL PRESSURE resolution for range r4 : ..., -2=100, -1=10, 0=1, 1=0.1, 2=0.01, ...		✓		
5064	W	Unit of measurement for TEMPERATURE with Pt100 sensor of HP3517E... probe: 0=°C, 1=°F.		✓		
6000 + 200x(N-1)	W	Unit of measurement for TEMPERATURE with 2-wire Pt100 sensor of channel N : 0=°C, 1=°F.		✓		
6002 + 200x(N-1)	W	Unit of measurement for TEMPERATURE with 3-wire Pt100 sensor of channel N : 0=°C, 1=°F.		✓		
6004 + 200x(N-1)	W	Unit of measurement for TEMPERATURE with 4-wire Pt100 sensor of channel N : 0=°C, 1=°F.		✓		
6006 + 200x(N-1)	W	Unit of measurement for TEMPERATURE with 2-wire Pt1000 sensor of channel N : 0=°C, 1=°F.		✓		
6008 + 200x(N-1)	W	Unit of measurement for TEMPERATURE with 3-wire Pt1000 sensor of channel N : 0=°C, 1=°F.		✓		
6010 + 200x(N-1)	W	Unit of measurement for TEMPERATURE with 4-wire Pt1000 sensor of channel N : 0=°C, 1=°F.		✓		
6012 + 200x(N-1)	W	Unit of measurement for TEMPERATURE with TC_K sensor of channel N : 0=°C, 1=°F.		✓		
6014 + 200x(N-1)	W	Unit of measurement for TEMPERATURE with TC_J sensor of channel N : 0=°C, 1=°F.		✓		
6016 + 200x(N-1)	W	Unit of measurement for TEMPERATURE with TC_T sensor of channel N : 0=°C, 1=°F.		✓		
6018 + 200x(N-1)	W	Unit of measurement for TEMPERATURE with TC_N sensor of channel N : 0=°C, 1=°F.		✓		
6026 + 200x(N-1)	W	Unit of measurement for TEMPERATURE with TC_E sensor of channel N : 0=°C, 1=°F.		✓		
6036 + 200x(N-1)	W	Measurement unit of the quantity associated to channel N if the channel is configured as 0...1 V input (HD35EDH). See TAB 10.1		✓		
6037 + 200x(N-1)	SW	Resolution of the quantity associated to channel N if the channel is configured as 0...1 V input (HD35EDH): ..., -2=100, -1=10, 0=1, 1=0.1, 2=0.01, ...		✓		
6038 + 200x(N-1)	W	Measurement unit of the quantity associated to channel N if the channel is configured as 0...50 mV (HD35EDH). See TAB 10.1		✓		
6039 + 200x(N-1)	SW	Resolution of the quantity associated to channel N if the channel is configured as 0...50 mV (HD35EDH): ..., -2=100, -1=10, 0=1, 1=0.1, 2=0.01, ...		✓		
6040 + 200x(N-1)	W	Measurement unit of the quantity associated to channel N if the channel is configured as 4...20 mA input (HD35EDH). See TAB 10.1		✓		
6041 + 200x(N-1)	SW	Resolution of the quantity associated to channel N if the channel is configured as 4...20 mA input (HD35EDH): ..., -2=100, -1=10, 0=1, 1=0.1, 2=0.01, ...		✓		
6042 + 200x(N-1)	W	Measurement unit of the quantity associated to channel N if the channel is configured as potentiometric input (HD35EDH). See TAB 10.1		✓		

Address	Type	Input Register description	AP	ED	RE	AL
6043 + 200x(N-1)	SW	Resolution of the quantity associated to channel N if the channel is configured as potentiometric input (HD35EDH): ..., -2=100, -1=10, 0=1, 1=0.1, 2=0.01, ...		✓		
9002	W	Measurement unit of the quantity associated to channel N if the channel is configured as counter (HD35EDH). See TAB 10.1		✓		
9003	SW	Resolution of the quantity associated to channel N if the channel is configured as counter (HD35EDH): ..., -2=100, -1=10, 0=1, 1=0.1, 2=0.01, ...		✓		
General information						
10000	W	Year of last measurement.		✓		
10001	W	Month of last measurement.		✓		
10002	W	Day of last measurement.		✓		
10003	W	Hour of last measurement.		✓		
10004	W	Minutes of last measurement.		✓		
10005	W	Seconds of last measurement.		✓		
10006	W	Packet Error Rate in % of the device (x10).		✓	✓	✓
10007	W	Number of RF hops of the last transmitted packet.		✓	✓	✓
10008	SW	RF signal level in dBm (relating to last RF hop).		✓	✓	✓
10009	W	Battery level: 0=empty, 1=half full , 2=full, 3=external power supply	✓	✓	✓	✓
10010	W	Time, in seconds, elapsed since the last transmitted packet.		✓	✓	✓
10011	W	RF signal level expressed as 0 to 7 scale.		✓	✓	✓
10012	W	Modbus address of the AP to which the device is connected.		✓	✓	✓
10013	W	Password level for the current connection: 0=no password, 1=user level, 2= administrator level	✓			
10014	W	Battery remaining capacity in %.	✓		✓	
10015	W	Estimation of battery remaining capacity in hours (x10).	✓		✓	
10016	W	Type of power supply: 0=battery, 1=USB, 2=ext. power supply	✓		✓	
10017	W	Estimation of battery remaining capacity in weeks		✓		✓
10018	W	Alarm relay #1 status: 0=deactivated, 1=intermittent, 2=active, 3=undetermined				✓
10019	W	Alarm relay #2 status: 0=deactivated, 1=intermittent, 2=active, 3=undetermined				✓

TAB. 12.5: Holding Registers – Read/Write parameters

Address	Type	Holding Register description	AP	ED	RE	AL
Measurement alarm thresholds						
0	SW	Lower alarm threshold for TEMPERATURE with NTC10K sensor of channel 1 in the set measurement unit (x10).		✓		
1	SW	Higher alarm threshold for temperature with NTC10K sensor of channel 1 in the set measurement unit (x10).		✓		
2	SW	RH lower alarm threshold in % (x10). Only for models ...TC and ...TV .		✓		
3	SW	RH higher alarm threshold in % (x10). Only for models ...TC and ...TV.		✓		
4	SW	DEW POINT lower alarm threshold in the set measurement unit (x10).		✓		
5	SW	Dew point higher alarm threshold in the set measurement unit (x10).		✓		
6	SW	PARTIAL VAPOR PRESSURE lower alarm threshold in hPa (x100).		✓		
7	SW	Partial vapor pressure higher alarm threshold in hPa (x100).		✓		
8	SW	MIXING RATIO lower alarm threshold in g/Kg (x10).		✓		
9	SW	Mixing ratio higher alarm threshold in g/Kg (x10).		✓		
10	SW	ABSOLUTE HUMIDITY lower alarm threshold in g/m ³ (x10).		✓		
11	SW	Absolute humidity higher alarm threshold in g/m ³ (x10).		✓		
12	SW	WET BULB TEMPERATURE lower alarm threshold in the set measurement unit (x10).		✓		
13	SW	Wet bulb temperature higher alarm threshold in the set measurement unit (x10).		✓		
16	SW	Lower alarm threshold for TEMPERATURE with NTC10K sensor of channel 2 in the set measurement unit (x10).		✓		
17	SW	Higher alarm threshold for temperature with NTC10K sensor of channel 2 in the set measurement unit (x10).		✓		
18	SW	Lower alarm threshold for SOLAR RADIATION in W/m ² .		✓		
19	SW	Higher alarm threshold for solar radiation in W/m ² .		✓		
20	SW	ILLUMINANCE lower alarm threshold in lux.		✓		
21	SW	Illuminance higher alarm threshold in lux		✓		
22	SW	CO lower alarm threshold in ppm.		✓		
23	SW	CO higher alarm threshold in ppm.		✓		
24	SW	ATMOSPHERIC PRESSURE lower alarm threshold in the set measurement unit (the multiplier depends on the set unit).		✓		
25	SW	Atmospheric pressure higher alarm threshold in the set measurement unit (the multiplier depends on the set unit).		✓		
30	SW	Lower alarm threshold for DAILY SOLAR RADIATION in Wh/m ² .		✓		
31	SW	Higher alarm threshold for daily solar radiation in Wh/m ² .		✓		
32	SW	CO₂ lower alarm threshold in ppm.		✓		
33	SW	CO ₂ higher alarm threshold in ppm.		✓		
46	SW	Lower alarm threshold for TEMPERATURE with sensor integrated in RH module in the set measurement unit (x10). Only for models ...TVI and ...AB .		✓		
47	SW	Higher alarm threshold for temperature with sensor integrated in RH module in the set measurement unit (x10). Only for models ...TVI and ...AB.		✓		
48	SW	RH lower alarm threshold in % (x10). Only for models ...TVI and ...AB .		✓		
49	SW	RH higher alarm threshold in % (x10). Only for models ...TVI and ...AB.		✓		

Address	Type	Holding Register description	AP	ED	RE	AL
50	SW	Lower alarm threshold for TEMPERATURE with NTC10K sensor of channel 3 in the set measurement unit (x10).		✓		
51	SW	Higher alarm threshold for temperature with NTC10K sensor of channel 3 in the set measurement unit (x10).		✓		
52	SW	WIND SPEED lower alarm threshold in the set measurement unit (the multiplier depends on the set unit).		✓		
53	SW	Wind speed higher alarm threshold in the set measurement unit (multiplier depends on the set unit).		✓		
54	SW	WIND DIRECTION lower alarm threshold in degrees (x10).		✓		
55	SW	Wind direction higher alarm threshold in degrees (x10).		✓		
56	SW	DIFFERENTIAL PRESSURE lower alarm threshold for range r3 in the set measurement unit (the multiplier depends on the set unit).		✓		
57	SW	Differential pressure higher alarm threshold for range r3 in the set measurement unit (multiplier depends on the set unit).		✓		
58	SW	Lower alarm threshold for WIND CHILL in the set measurement unit (x10).		✓		
59	SW	Higher alarm threshold for wind chill in the set measurement unit (x10).		✓		
60	SW	DIFFERENTIAL PRESSURE lower alarm threshold for ranges r1 and r2 in the set measurement unit (the multiplier depends on the set unit).		✓		
61	SW	Differential pressure higher alarm threshold for ranges r1 and r2 in the set measurement unit (the multiplier depends on the set unit).		✓		
62	SW	DIFFERENTIAL PRESSURE lower alarm threshold for range r4 in the set measurement unit (the multiplier depends on the set unit).		✓		
63	SW	Differential pressure higher alarm threshold for range r4 in the set measurement unit (the multiplier depends on the set unit).		✓		
64	SW	Lower alarm threshold for TEMPERATURE with Pt100 sensor of HP3517E... probe in the set measurement unit (x10).		✓		
65	SW	Higher alarm threshold for temperature with Pt100 sensor of HP3517E... probe in the set measurement unit (x10).		✓		
66	SW	Lower alarm threshold for PYRANOMETER OUTPUT in mV (x100).		✓		
67	SW	Higher alarm threshold for PYRANOMETER OUTPUT in mV (x100).		✓		
68	SW	UVA IRRADIANCE lower alarm threshold in mW/m ² .		✓		
69	SW	UVA irradiance higher alarm threshold in mW/m ² .		✓		
70	SW	PROPORTION OF UV PRESENT lower alarm threshold in μW/lumen.		✓		
71	SW	Proportion of UV present higher alarm threshold in μW/lumen.		✓		
Measurement alarm thresholds for configurable inputs						
1000 + 200x(N-1)	SW	Lower alarm threshold for TEMPERATURE with 2-wire Pt100 sensor of channel N in the set measurement unit (x10).		✓		
1001 + 200x(N-1)	SW	Higher alarm threshold for temperature with 2-wire Pt100 sensor of channel N in the set measurement unit (x10).		✓		
1002 + 200x(N-1)	SW	Lower alarm threshold for TEMPERATURE with 3-wire Pt100 sensor of channel N in the set measurement unit (x10).		✓		
1003 + 200x(N-1)	SW	Higher alarm threshold for temperature with 3-wire Pt100 sensor of channel N in the set measurement unit (x10).		✓		
1004 + 200x(N-1)	SW	Lower alarm threshold for TEMPERATURE with 4-wire Pt100 sensor of channel N in the set measurement unit (x10).		✓		
1005 + 200x(N-1)	SW	Higher alarm threshold for temperature with 4-wire Pt100 sensor of channel N in the set measurement unit (x10).		✓		
1006 + 200x(N-1)	SW	Lower alarm threshold for TEMPERATURE with 2-wire Pt1000 sensor of channel N in the set measurement unit (x10).		✓		

Address	Type	Holding Register description	AP	ED	RE	AL
1007 + 200x(N-1)	SW	Higher alarm threshold for temperature with 2-wire Pt1000 sensor of channel N in the set measurement unit (x10).		✓		
1008 + 200x(N-1)	SW	Lower alarm threshold for TEMPERATURE with 3-wire Pt1000 sensor of channel N in the set measurement unit (x10).		✓		
1009 + 200x(N-1)	SW	Higher alarm threshold for temperature with 3-wire Pt1000 sensor of channel N in the set measurement unit (x10).		✓		
1010 + 200x(N-1)	SW	Lower alarm threshold for TEMPERATURE with 4-wire Pt1000 sensor of channel N in the set measurement unit (x10).		✓		
1011 + 200x(N-1)	SW	Higher alarm threshold for temperature with 4-wire Pt1000 sensor of channel N in the set measurement unit (x10).		✓		
1012 + 200x(N-1)	SW	Lower alarm threshold for TEMPERATURE with TC_K sensor of channel N in the set measurement unit (x10).		✓		
1013 + 200x(N-1)	SW	Higher alarm threshold for temperature with TC_K sensor of channel N in the set measurement unit (x10).		✓		
1014 + 200x(N-1)	SW	Lower alarm threshold for TEMPERATURE with TC_J sensor of channel N in the set measurement unit (x10).		✓		
1015 + 200x(N-1)	SW	Higher alarm threshold for temperature with TC_J sensor of channel N in the set measurement unit (x10).		✓		
1016 + 200x(N-1)	SW	Lower alarm threshold for TEMPERATURE with TC_T sensor of channel N in the set measurement unit (x10).		✓		
1017 + 200x(N-1)	SW	Higher alarm threshold for temperature with TC_T sensor of channel N in the set measurement unit (x10).		✓		
1018 + 200x(N-1)	SW	Lower alarm threshold for TEMPERATURE with TC_N sensor of channel N in the set measurement unit (x10).		✓		
1019 + 200x(N-1)	SW	Higher alarm threshold for temperature with TC_N sensor of channel N in the set measurement unit (x10).		✓		
1026 + 200x(N-1)	SW	Lower alarm threshold for TEMPERATURE with TC_E sensor of channel N in the set measurement unit (x10).		✓		
1027 + 200x(N-1)	SW	Higher alarm threshold for temperature with TC_E sensor of channel N in the set measurement unit (x10).		✓		
1028 + 200x(N-1)	SW	Channel N lower alarm threshold in mV (x10). Only if channel N is configured as 0...1 V input (HD35EDH).		✓		
1029 + 200x(N-1)	SW	Channel N higher alarm threshold in mV (x10). Only if channel N is configured as 0...1 V input (HD35EDH).		✓		
1030 + 200x(N-1)	SW	Channel N lower alarm threshold in mV (x100). Only if channel N is configured as 0...50 mV input (HD35EDH).		✓		
1031 + 200x(N-1)	SW	Channel N higher alarm threshold in mV (x100). Only if channel N is configured as 0...50 mV input (HD35EDH).		✓		
1032 + 200x(N-1)	SW	Channel N lower alarm threshold in mA (x100). Only if channel N is configured as 4...20 mA input (HD35EDH).		✓		
1033 + 200x(N-1)	SW	Channel N higher alarm threshold in mA (x100). Only if channel N is configured as 4...20 mA input (HD35EDH).		✓		
1034 + 200x(N-1)	SW	Channel N lower alarm threshold in % . Only if channel N is configured as potentiometric input (HD35EDH).		✓		
1035 + 200x(N-1)	SW	Channel N higher alarm threshold in % . Only if channel N is configured as potentiometric input (HD35EDH).		✓		
1036 + 200x(N-1)	SW	Lower alarm threshold expressed as value of the quantity associated to channel N when the channel is configured as 0...1 V input (HD35EDH).		✓		
1037 + 200x(N-1)	SW	Higher alarm threshold expressed as value of the quantity associated to channel N when the channel is configured as 0...1 V input (HD35EDH).		✓		
1038 + 200x(N-1)	SW	Lower alarm threshold expressed as value of the quantity associated to channel N when the channel is configured as 0...50 mV (HD35EDH).		✓		

Address	Type	Holding Register description	AP	ED	RE	AL
1039 + 200 x (N-1)	SW	Higher alarm threshold expressed as value of the quantity associated to channel N when the channel is configured as 0...50 mV (HD35EDH).		✓		
1040 + 200 x (N-1)	SW	Lower alarm threshold expressed as value of the quantity associated to channel N when the channel is configured as 4...20 mA (HD35EDH).		✓		
1041 + 200 x (N-1)	SW	Higher alarm threshold expressed as value of the quantity associated to channel N when the channel is configured as 4...20 mA (HD35EDH).		✓		
1042 + 200 x (N-1)	SW	Lower alarm threshold expressed as value of the quantity associated to channel N when the channel is configured as potentiometric input (HD35EDH).		✓		
1043 + 200 x (N-1)	SW	Higher alarm threshold expressed as value of the quantity associated to channel N when the channel is configured as potentiometric input (HD35EDH).		✓		
4000 to 4001	SW	Lower alarm threshold as number of counts . Only if the channel is configured as counter (HD35EDH).		✓		
4002 to 4003	SW	Higher alarm threshold as number of counts . Only if the channel is configured as counter (HD35EDH).		✓		
4004 to 4005	SW	Lower alarm threshold expressed as value of the quantity associated to the channel when the channel is configured as counter (HD35EDH).		✓		
4006 to 4007	SW	Higher alarm threshold expressed as value of the quantity associated to the channel when the channel is configured as counter (HD35EDH).		✓		
General information						
10000 to 10019	B	User code with ASCII codification. Acceptable values are in the set {32,...,126}.	✓	✓	✓	✓
10020	W	Current year	✓			
10021	W	Current month	✓			
10022	W	Current day	✓			
10023	W	Current hour	✓			
10024	W	Current minute	✓			
10025	W	Current second	✓			
10026	W	Measurement interval: 0=1s, 1=2s, 2=5s, 3=10s, 4=15s, 5=30s, 6=1min, 7=2min, 8=5min, 9=10min, 10=15min, 11=30min, 12=1h		✓		
10027	W	Logging/RF interval: 0=1s, 1=2s, 2=5s, 3=10s, 4=15s, 5=30s, 6=1min, 7=2min, 8=5min, 9=10min, 10=15min, 11=30min, 12=1h		✓		✓
10029	W	Network RF channel. By changing this register, all network devices migrate to the new RF channel.	✓			
10030	W	Max number of RF transmissions for each command sent by AP to a remote device.	✓			
10031	W	Packet Error Rate threshold in % (x10) for RF alarms generation (for ex. 500 means 50.0%)	✓			
10032	W	Temperature measurement unit: 0=°C, 1=°F The setting is extended to all EDs except for mapped quantities in HD35EDH	✓			
10033	W	Atmospheric pressure measurement unit: see TAB 10.1. The setting extends to all EDs except for mapped quantities in HD35EDH	✓			
10034	W	Baud rate RS485: 0=9600, 1=19200, 3=38400 bit/s	✓			
10035	W	RS485 communication mode: 0=8N1, 1=8N2, 2=8E1, 3=8E2, 4=8O1, 5=8O2	✓			
10036	W	Password to be supplied to enable configuration change commands. The reading provides the fixed value 32768.	✓			

Address	Type	Holding Register description	AP	ED	RE	AL
10037	B	Device group with ASCII codification. Acceptable values are in the set {32,...,126}.	✓	✓	✓	✓
10047	W	Wind speed measurement unit: see TAB 10.1. The setting is extended to all EDs except for the mapped quantities in HD35EDH	✓			
10048	W	Rainfall quantity measurement unit: see TAB 10.1. The setting is extended to all EDs except for the mapped quantities in HD35EDH	✓			
10049	W	Differential pressure measurement unit for ranges r1, r2 and r3: see TAB 10.1. The setting is extended to all EDs except for the mapped quantities in HD35EDH	✓			
10050	W	Differential pressure measurement unit for range r4: see TAB 10.1. The setting is extended to all EDs except for the mapped quantities in HD35EDH	✓			
10051	W	Rain gauge resolution, in thousandths of mm <i>Example: 0200 ⇒ 0.200 mm</i>		✓		
10052	W	Setting of the quantities to be displayed in the automatic viewing cycle for models HD35EDLW... without keyboard. Set the i-th bit (starting from LSB) to 1 if you wish to include the i-th quantity in the viewing cycle. <i>Example: if in the model measuring and calculating: 1=Temp., 2=RH, 3=Td, 4=PVP, 5=Mix.Ratio, 6=AH, 7=Tw, the register is set to 0000 0000 0010 0010, only the relative humidity (RH) and the absolute humidity (AH) will be displayed alternatively.</i>		✓		
10053	W	Setting of the RF quantities (RSSI, PER%) to be displayed in the automatic viewing cycle for models HD35EDLW... without keyboard. Set the i-th bit (starting from LSB) to 1 if you wish to include the i-th RF quantity in the viewing cycle.		✓		
10054	W	Period, in hours, of CO ₂ sensor auto calibration.		✓		
10055	W	Period, in hours, after which the first CO ₂ auto calibration after activation will occur.		✓		
10056	W	CO ₂ reference value (in ppm) for auto calibration.		✓		
10057	W	CO ₂ maximum acceptable variation (in ppm), with respect to the reference value, for auto calibration.		✓		
10058	W	Relay #1 activation duration in seconds (1...54000 s) in case of cyclical activation (<i>Coils - address 18 = 0</i>).				✓
10059	W	Relay #1 deactivation duration in seconds (1...54000 s) in case of cyclical activation (<i>Coils - address 18 = 0</i>).				✓
10060	W	Number of relay #1 activations in case of cyclical activation (<i>Coils - address 18 = 0</i>).				✓
10061	W	Relay #2 activation duration in seconds (1...54000 s) in case of cyclical activation (<i>Coils - address 21 = 0</i>).				✓
10062	W	Relay #2 deactivation duration in seconds (1...54000 s) in case of cyclical activation (<i>Coils - address 21 = 0</i>).				✓
10063	W	Number of relay #2 activations in case of cyclical activation (<i>Coils - address 21 = 0</i>).				✓
20000 to 20011	B	User code with ASCII codification of measurement #1. Available for models with more measurements of the same type.		✓		
20012 to 20023	B	User code with ASCII codification of measurement #2. Available for models with more measurements of the same type.		✓		
20024 to 20035	B	User code with ASCII codification of measurement #3. Available for models with more measurements of the same type.		✓		
20036 to 20047	B	User code with ASCII codification of measurement #4. Available for models with more measurements of the same type.		✓		
20048 to 20059	B	User code with ASCII codification of measurement #5. Available for models with more measurements of the same type.		✓		
20060 to 20071	B	User code with ASCII codification of measurement #6. Available for models with more measurements of the same type.		✓		

Address	Type	Holding Register description	AP	ED	RE	AL
20072 to 20083	B	User code with ASCII codification of measurement #7. Available for models with more measurements of the same type.		✓		
20084 to 20095	B	User code with ASCII codification of measurement #8. Available for models with more measurements of the same type.		✓		
20096 to 20107	B	User code with ASCII codification of measurement #9. Available for models with more measurements of the same type.		✓		
20108 to 20119	B	User code with ASCII codification of measurement #10. Available for models with more measurements of the same type.		✓		
20120 to 20131	B	User code with ASCII codification of measurement #11. Available for models with more measurements of the same type.		✓		
20132 to 20143	B	User code with ASCII codification of measurement #12. Available for models with more measurements of the same type.		✓		

Warning: the execution of MODBUS commands changing the parameters setting of a device can take a certain time, due to the RF transmission between the device and the base unit. The value of the flag PENDING_CONF (Discrete Inputs – address 2) is set to 1 during the execution of a configuration change request. Only when the flag returns to 0 the request is considered as concluded. The flag CMD_FAILURE (Coils – address 7) allows to check whether the request was successful. It is recommended to check the status of the two flags before considering a device configuration changed.

13 DIMENSIONS

The following figures show the dimensions of the instruments in mm.

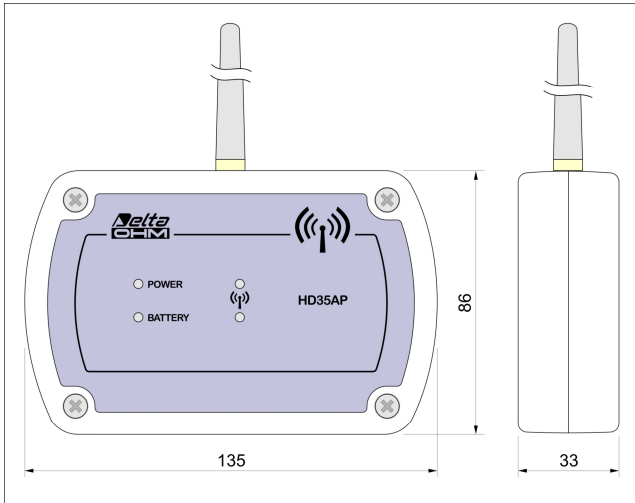

HD35AP - HD35APW - HD35APG - HD35RE

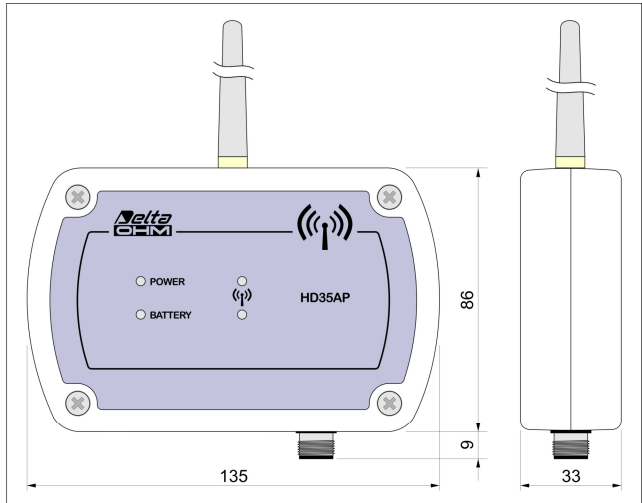

HD35APS

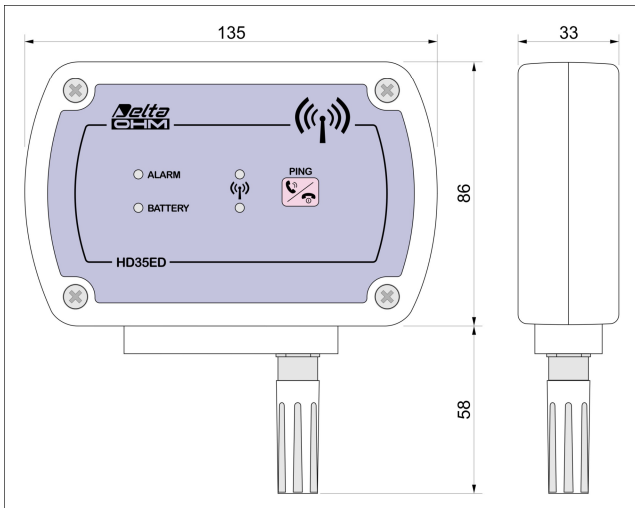

HD35ED... versions with fixed RH/T probe

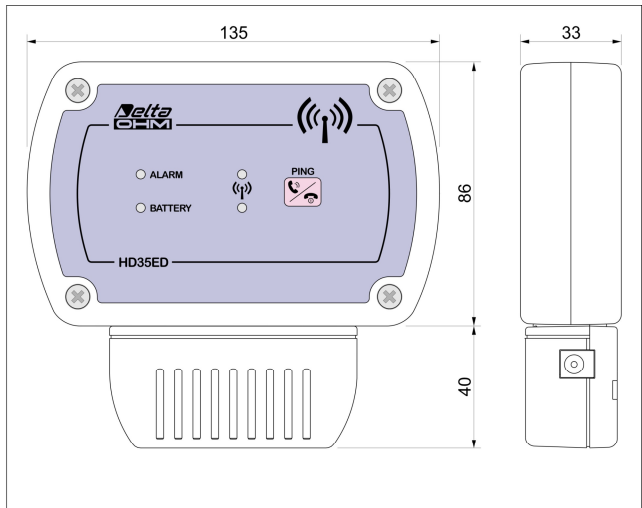

HD35ED... versions with grid

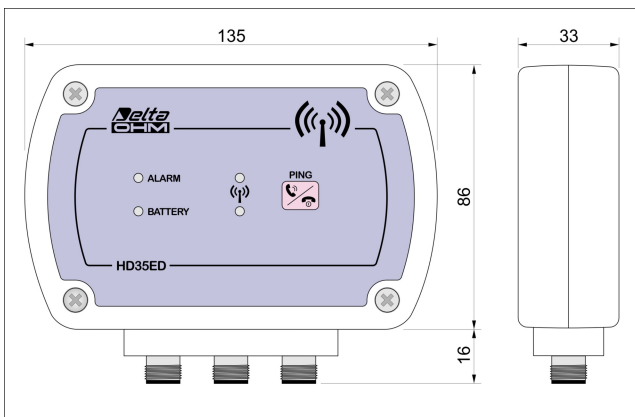

HD35ED... versions with M12 connectors

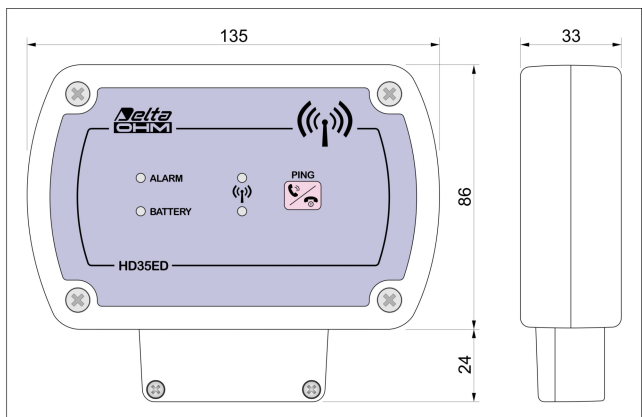

HD35ED... versions with terminals

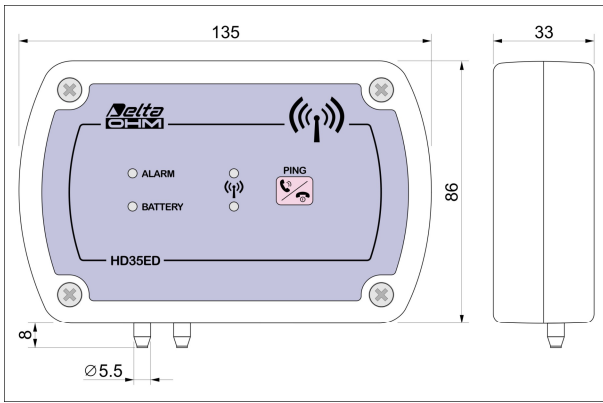

HD35ED... versions with differential pressure inputs

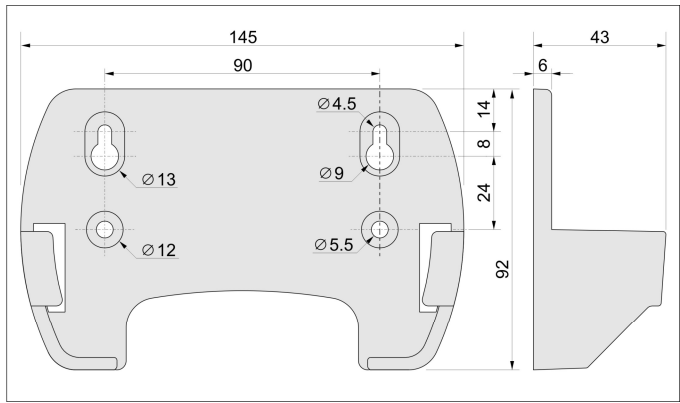

Support for removable installation

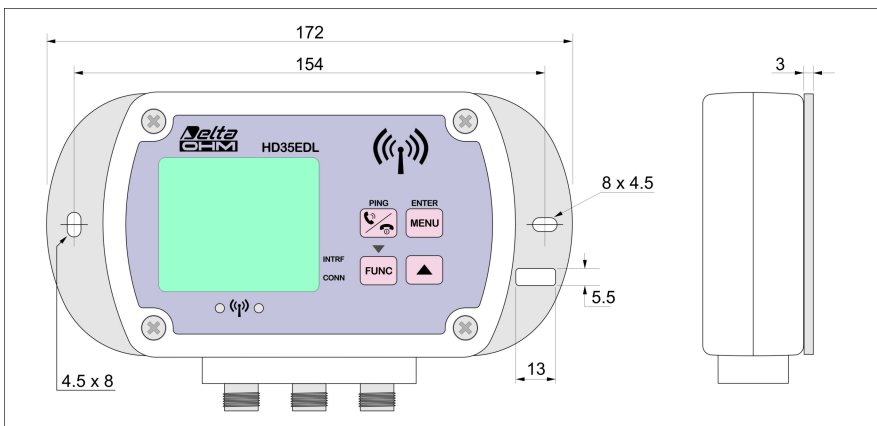

Flanges for fixed installation

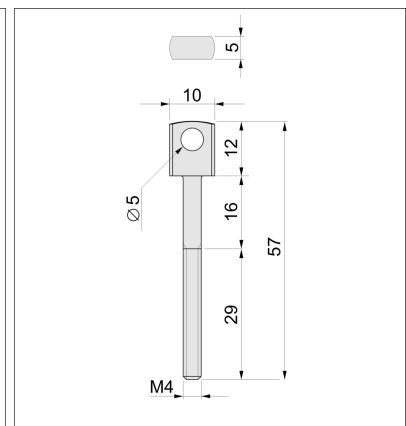

Lock pin

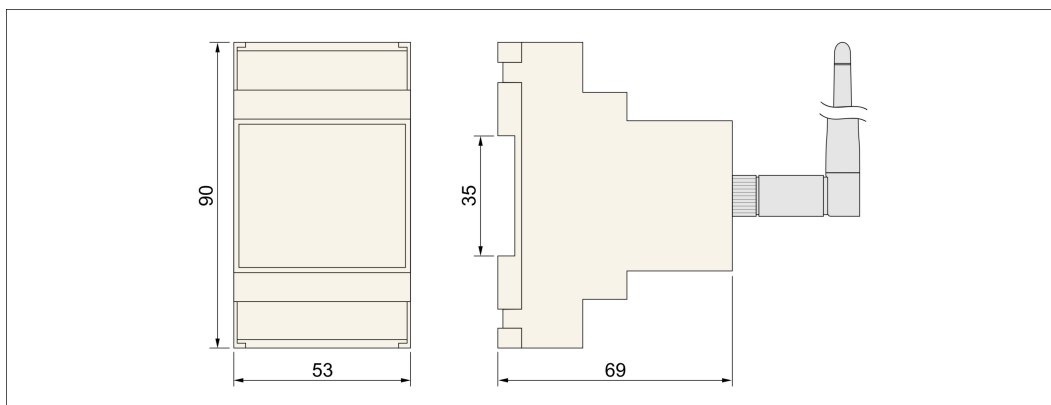

HD35APR

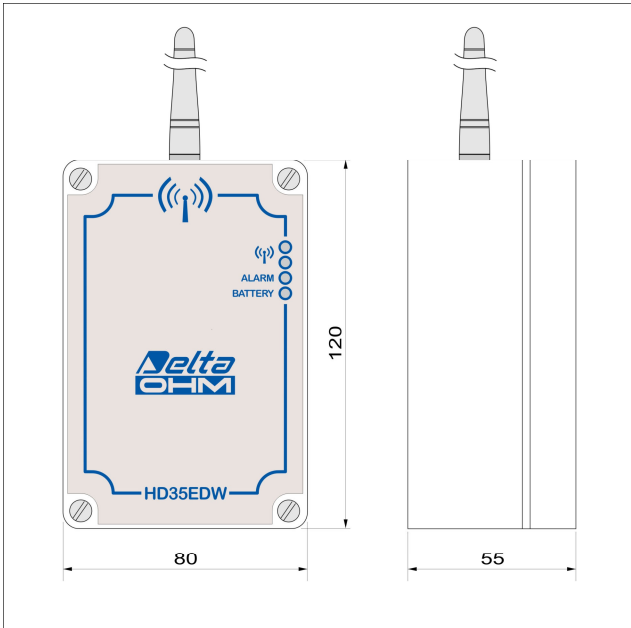

HD35REW

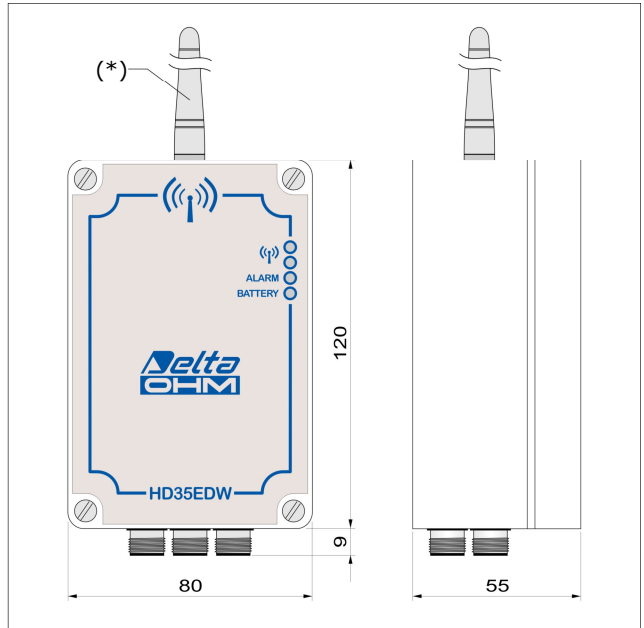

HD35EDW... versions with M12 connectors

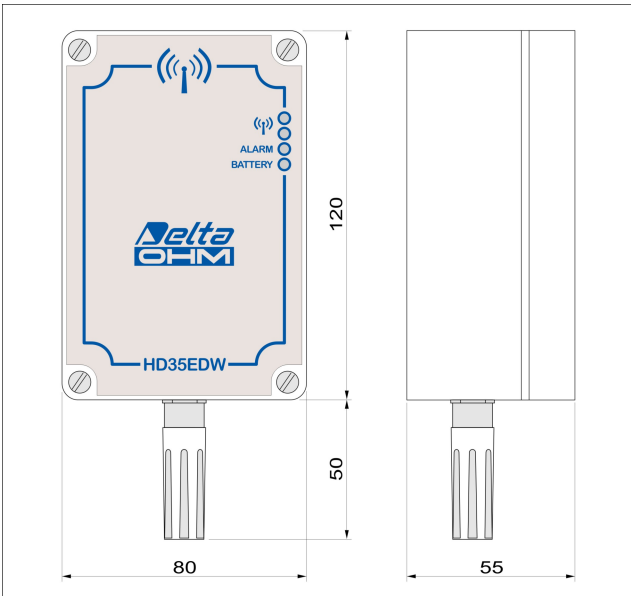

HD35EDW... versions with fixed RH/T probe

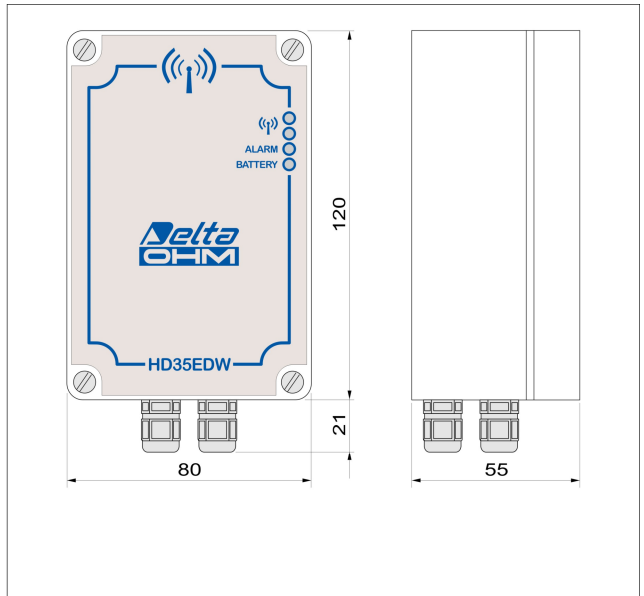

HD35EDW... versions with terminal header

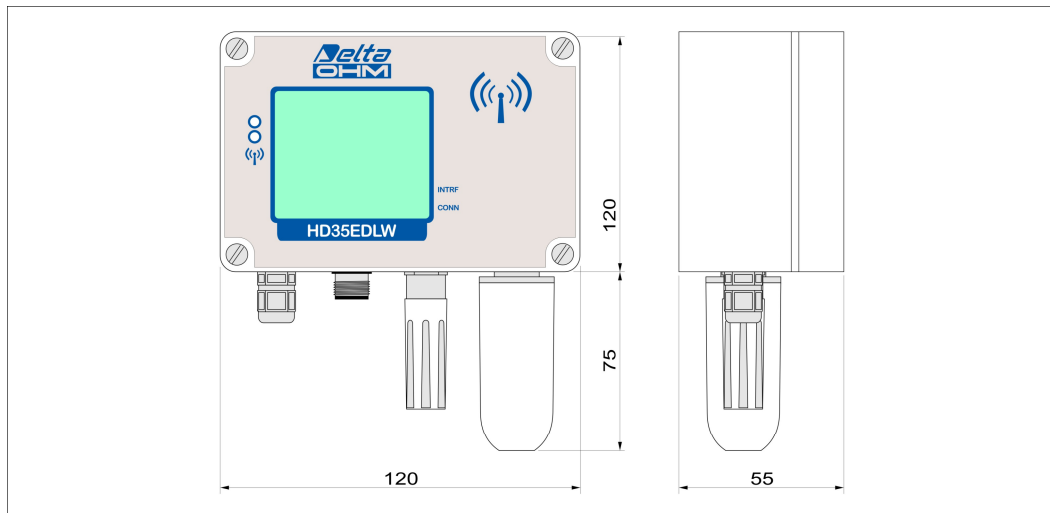

HD35EDW... versions with CO₂ probe

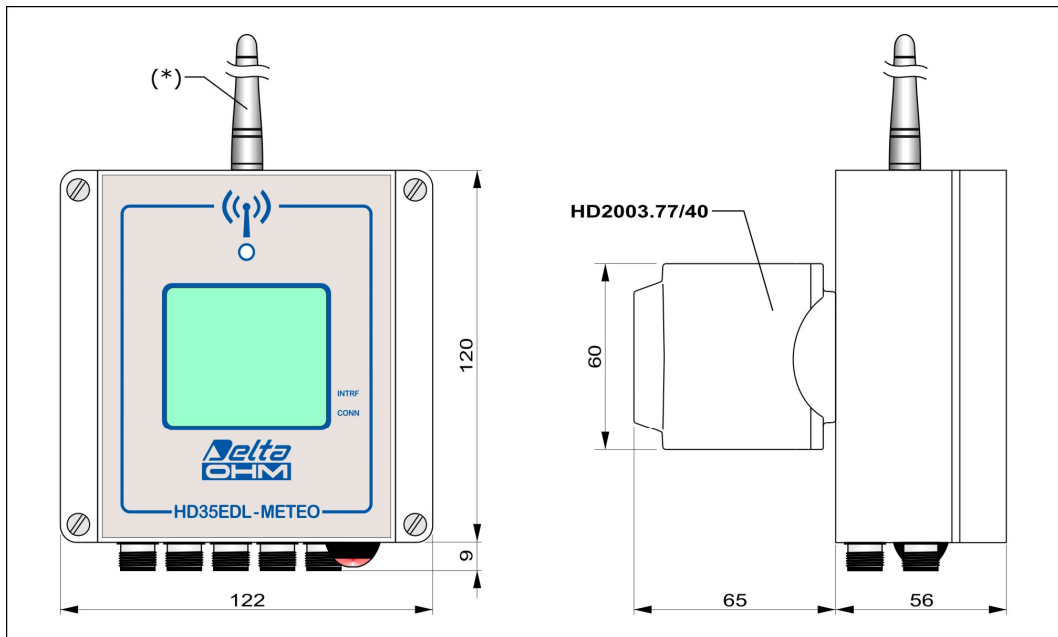

HD35EDLM...TC

(*) In the models HD35EDW... and HD35EDLM...TC the antenna is external for outdoor installation with protection shield against solar radiations; the antenna is internal for indoor installation.

14 RELATIVE HUMIDITY AND TEMPERATURE PROBES

Combined probes for temperature and relative humidity:

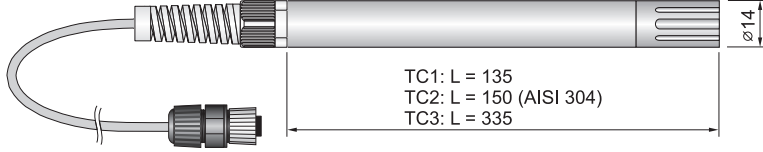
HP3517...	
	
<i>R.H. Sensor</i>	Capacitive (the sensor can be calibrated by user)
<i>Temperature sensor</i>	NTC 10 kΩ @ 25 °C (HP3517TC...) Pt100 1/3 DIN (HP3517ETC...)
<i>R.H. sensor measurement range</i>	0...100 %RH
<i>Temperature sensor measurement range</i>	-40...+105 °C (HP3517TC... with NTC 10 kΩ sensor) -40...+150 °C (HP3517ETC... with Pt100 sensor)
<i>R.H. sensor operating temperature</i>	-20...+80 °C standard -40...+150 °C with option E
<i>Accuracy</i>	<i>standard</i> ± 2.5 %RH (0..90 %RH) / ± 3.5 %RH (remaining range) <i>with option E</i> ± 2 %RH (0..90 %RH) / ± 3 %RH (remaining range)
<i>Cable length</i>	2, 5 or 10 m standard
<i>Connection</i>	4-pole M12 female connector

Temperature probes with Pt100 and Pt1000 1/3 DIN thin film sensor:

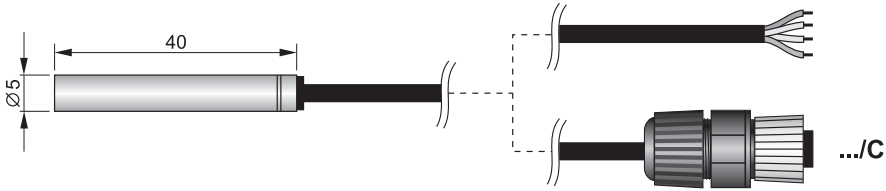
TP35.1...	
	
<i>Sensor</i>	4-wire Pt1000
<i>Temperature range</i>	-50...+105 °C
<i>Accuracy</i>	1/3 DIN
<i>Cable length</i>	3, 5 or 10 m standard, other lengths on request
<i>Connection</i>	Free wires or 4-pole M12 female connector (option /C)
<i>Material</i>	AISI 316 stainless steel tube

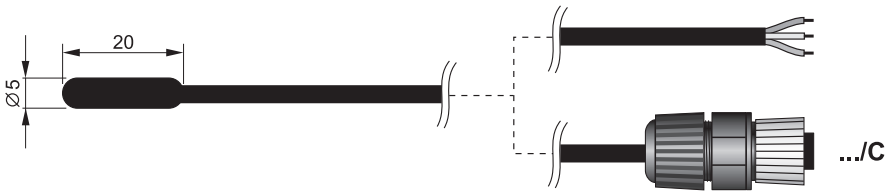
TP35.2...	
	
<i>Sensor</i>	3-wire Pt1000
<i>Temperature range</i>	0...+70 °C
<i>Accuracy</i>	1/3 DIN
<i>Cable length</i>	3 or 5 m standard, other lengths on request
<i>Connection</i>	Free wires or 4-pole M12 female connector (option /C)
<i>Material</i>	Thermo-plastic rubber

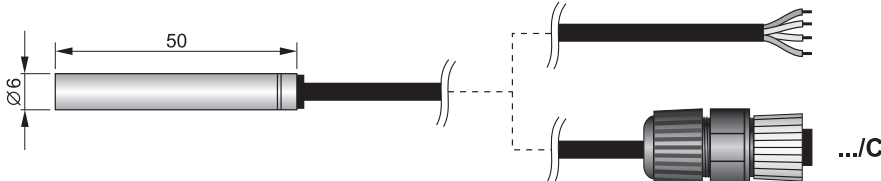
TP35.4...	
	
<i>Sensor</i>	4-wire Pt100
<i>Temperature range</i>	-50...+105 °C
<i>Accuracy</i>	1/3 DIN
<i>Cable length</i>	3, 5 or 10 m standard, other lengths on request
<i>Connection</i>	Free wires or 4-pole M12 female connector (option /C)
<i>Material</i>	AISI 316 stainless steel tube

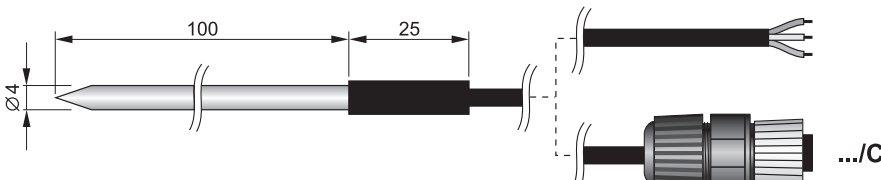
TP35.5...	
	
<i>Sensor</i>	3-wire Pt1000
<i>Temperature range</i>	-40...+300 °C
<i>Accuracy</i>	1/3 DIN
<i>Cable length</i>	3 or 5 m standard, other lengths on request
<i>Connection</i>	Free wires or 4-pole M12 female connector (option /C)
<i>Material</i>	AISI 316 stainless steel tube

TP35878ISS...	
	
<i>Sensor</i>	4-wire Pt100
<i>Temperature range</i>	-40...+85 °C
<i>Accuracy</i>	1/3 DIN
<i>Cable length</i>	5 or 10 m standard, other lengths on request
<i>Connection</i>	4-pole M12 female connector

Temperature probes with NTC 10K Ω @ 25 °C sensor:

TP35N1...	
<i>Sensor</i>	NTC 10 k Ω @ 25 °C
<i>Temperature range</i>	-20...+75 °C
<i>Accuracy</i>	$\pm 0.3^\circ\text{C}$ in the range 0...+70 °C / $\pm 0.4^\circ\text{C}$ outside
<i>Cable length</i>	3, 5 o 10 m standard, other lengths on request
<i>Connection</i>	Free wires or 4-pole M12 female connector (option /C)
<i>Material</i>	AISI 316 stainless steel tube

TP35N2...	
<i>Sensor</i>	NTC 10 k Ω @ 25 °C
<i>Temperature range</i>	0...+70 °C
<i>Accuracy</i>	$\pm 0.3^\circ\text{C}$
<i>Cable length</i>	3, 5 o 10 m standard, other lengths on request
<i>Connection</i>	Free wires or 4-pole M12 female connector (option /C)
<i>Material</i>	AISI 316 stainless steel tube

TP35N5...	
<i>Sensor</i>	NTC 10 k Ω @ 25 °C
<i>Temperature range</i>	-20...+105 °C
<i>Accuracy</i>	$\pm 0.3^\circ\text{C}$ in the range 0...+70 °C / $\pm 0.4^\circ\text{C}$ outside
<i>Cable length</i>	3 o 5 m standard, other lengths on request
<i>Connection</i>	Free wires or 4-pole M12 female connector (option /C)
<i>Material</i>	AISI 316 stainless steel tube

TP35N6...

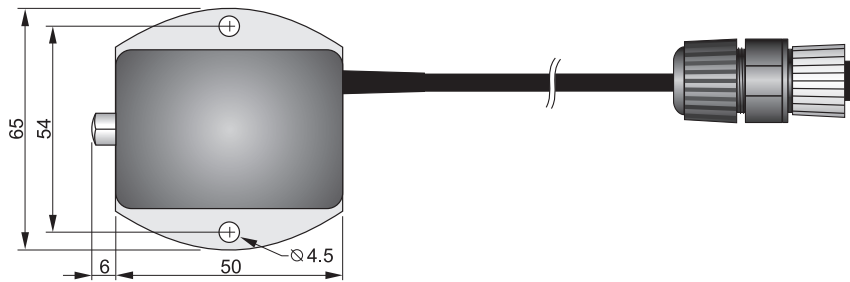

<i>Sensor</i>	NTC 10 kΩ @ 25 °C
<i>Temperature range</i>	-20...+70 °C
<i>Accuracy</i>	± 0.3 °C in the range 0...+70 °C / ± 0.4 °C outside
<i>Cable length</i>	5, 10, 15 or 20 m standard, other lengths on request
<i>Connection</i>	4-pole M12 female connector
<i>Material</i>	Plastic body, aluminum flange

HP3507TC...

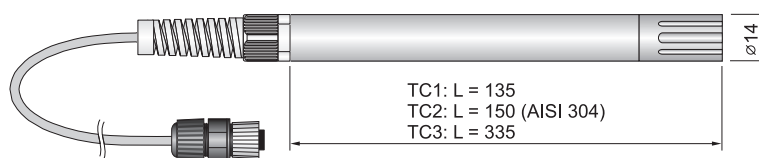

<i>Sensor</i>	NTC 10 kΩ @ 25 °C
<i>Temperature range</i>	-40...+105 °C
<i>Accuracy</i>	± 0.3 °C in the range 0...+70 °C / ± 0.4 °C outside
<i>Cable length</i>	2, 5 or 10 m standard
<i>Connection</i>	4-pole M12 female connector
<i>Material</i>	Pocan (TC1 and TC3) or AISI 304 (TC2)

Temperature probes with K thermocouple sensor:

TP35K6.5

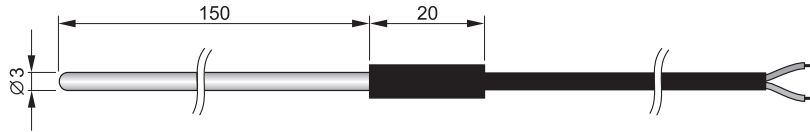

<i>Sensor</i>	K thermocouple with isolated junction
<i>Max temperature</i>	-50...+750 °C
<i>Accuracy</i>	Class 1 according to IEC 60584-2
<i>Cable length</i>	5 m standard, other lengths on request
<i>Connection</i>	Free wires
<i>Material</i>	AISI 316 stainless steel tube

Connections of Pt100, Pt1000 and NTC 10KΩ temperature probes with M12 connector:

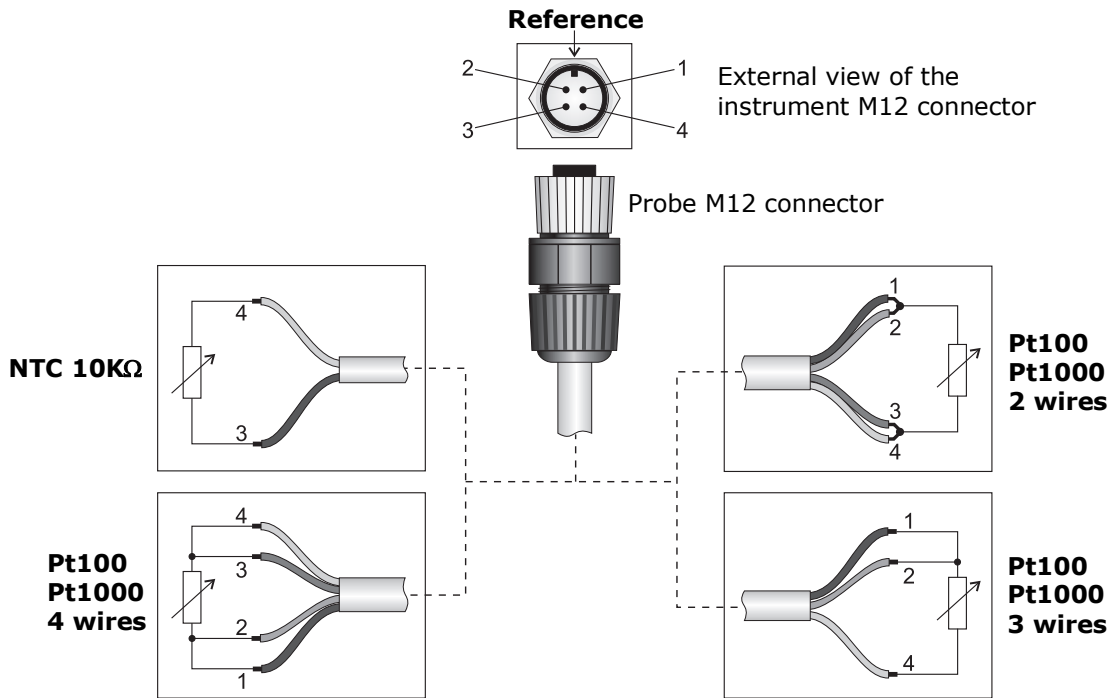

15 STORAGE OF INSTRUMENTS

Instruments storage conditions:

- Temperature: -40...+70 °C.
- Humidity: less than 90 %RH no condensation.
- In storage, avoid places where:
 - humidity is high;
 - instruments are exposed to direct sun radiation;
 - instruments are exposed to a high temperature source;
 - high vibration levels are present;
 - there are vapor, salt and/or corrosive gas.

16 SAFETY INSTRUCTIONS

General safety instructions

These instruments have been manufactured and tested in accordance with EN61010-1 safety directives for electronic measuring instruments and have left the factory in perfect safety technical conditions.

The instruments proper operation and operating safety can be ensured only if all standard safety measures as well as the specific measures described in this manual are followed.

The instruments proper operation and operating safety can be ensured only in the climatic conditions specified in this manual.

Do not use the instruments in places where there are:

- Rapid ambient temperature variations that may cause condensation.
- Corrosive or flammable gases.
- Direct vibrations or shocks to the instrument.
- High-intensity electromagnetic fields, static electricity.

If the instruments are moved from a cold place to a hot one, or vice versa, condensation formation can cause their malfunction. In this case, you will have to wait for the instruments temperature to reach ambient temperature before turning the instruments on.

User obligations

The instruments operator shall follow the directives and regulations below that refer to the treatment of dangerous materials:

- EEC directives on workplace safety
- National low regulations on workplace safety
- Accident prevention regulations

17 ORDERING CODES

BASE UNIT

HD35AP...

Base unit for the interfacing between the PC and the data loggers of the system. USB connection. Depending on the model, in addition to the USB output is available: RS485 output with MODBUS-RTU protocol, Wi-Fi interface, ETHERNET connection, GSM module. Powered by the PC USB port or external power adapter **SWD06** (optional, not for HD35APD and HD35APR). The unit is supplied with: internal lithium-ion rechargeable battery **HD35-BAT1** (not for HD35APD and HD35APR), software **HD35AP-S basic**, wall mount support **HD35.03** (not for HD35APD and HD35APR), operating manual.

Radio frequency (868, 902-928 or 915.9-929.7 MHz) should be specified upon ordering.

The serial cable **CP23**, the external power adapter **SWD06** and the kit **HD35.11K** (pair of flanges, pin for padlock and padlock) for fixed installation **have to be ordered separately.**

HD35APD and HD35APG are not available with radio frequency 915.9-929.7 MHz (Japan).

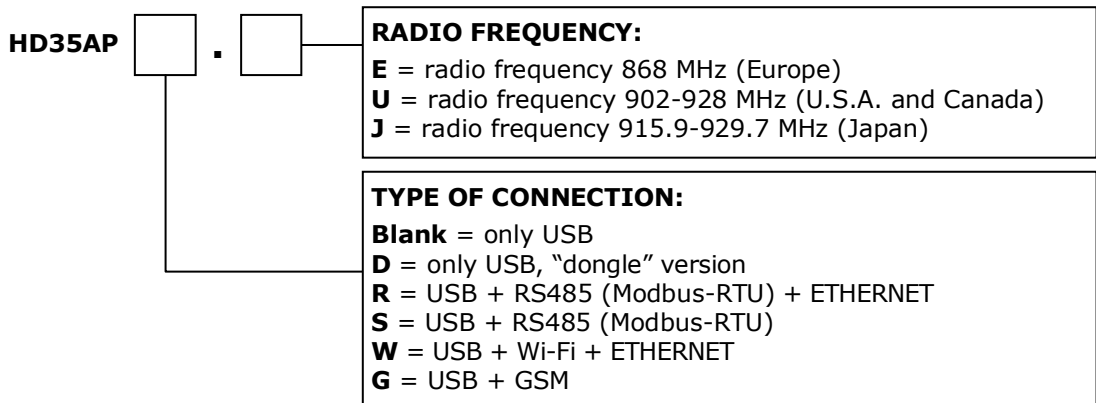

REPEATERS

HD35RE RF signal repeater. Housing for indoor. Power supply through PC USB port or external power supply unit **SWD06 (option)**. Supplied with: internal lithium-ion rechargeable battery **HD35-BAT1**, wall support **HD35.03**, instruction manual. **Radio frequency (868, 902-928 or 915.9-929.7 MHz) should be specified upon ordering.**
CP23 USB cable and **HD35.11K** kit (pair of flanges, lock pin and padlock) for fixed installation should be ordered separately.

HD35REW RF signal repeater. Waterproof housing. Powered by the internal battery. Supplied with: internal lithium-ion rechargeable battery **BAT-2013DB**, operating manual. **The radio frequency (868, 902-928 or 915.9-929.7 MHz) has to be specified when ordering.**
The shield from solar radiations **HD9217TF1** and the clamp **HD2003.77/40** for fixing to the mast or the flange **HD35.24W** for fixing to the wall should be ordered separately.

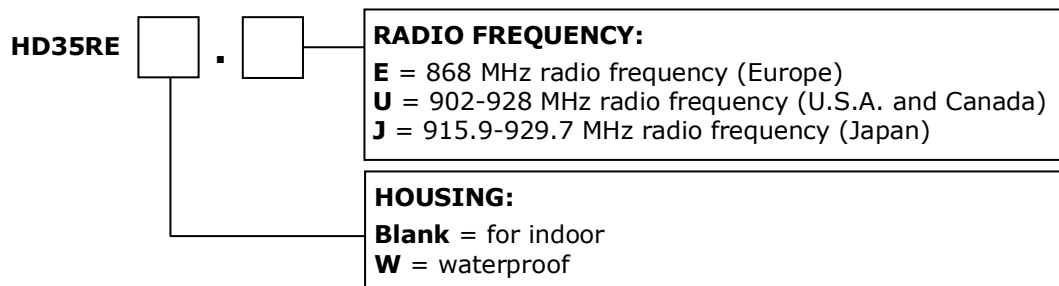

ALARM MODULE

HD35ED-ALM Module with two relay outputs for signaling alarm events. Power supply through non-rechargeable lithium-thionyl-chloride (Li-SOCl₂) 3.6V internal battery, battery life: 1 year typical. Supplied with: battery **HD35-BAT2**, wall support **HD35.03**, instruction manual. **Radio frequency (868, 902-928 or 915.9-929.7 MHz) should be specified upon ordering.**
HD35.11K kit (pair of flanges, lock pin and padlock) for fixed installation should be ordered separately.

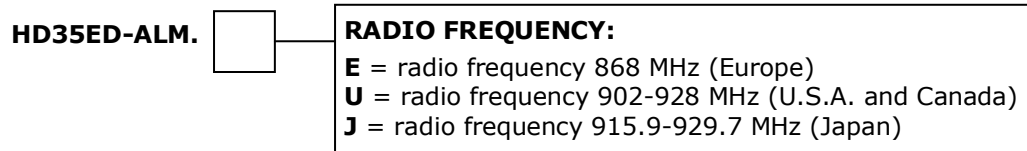

DATA LOGGER

HD35ED...

Wireless data logger. Stores measurements in the internal memory. Transmits the acquired data to the base unit automatically at regular intervals or on request. **Optional LCD Display.** Acoustic alarm with internal buzzer. Power supply through non-rechargeable lithium-thionyl-chloride (Li-SOCl₂) 3.6V internal battery. Supplied with: battery, wall support **HD35.03** (only for indoor-use models), instruction manual.

Radio frequency (868, 902-928 or 915.9-929.7 MHz) should be specified upon ordering. External probes have to be ordered separately.

The kit **HD35.11K** (pair of flanges, lock pin and padlock) for fixed installation of indoor housing has to be ordered separately.

For versions with waterproof housing, **specify upon ordering if the instrument should be installed outside with protection shield (optional) against solar radiations, and if the housing should be supplied with HD2003.77/40 (optional) clamping already assembled.**

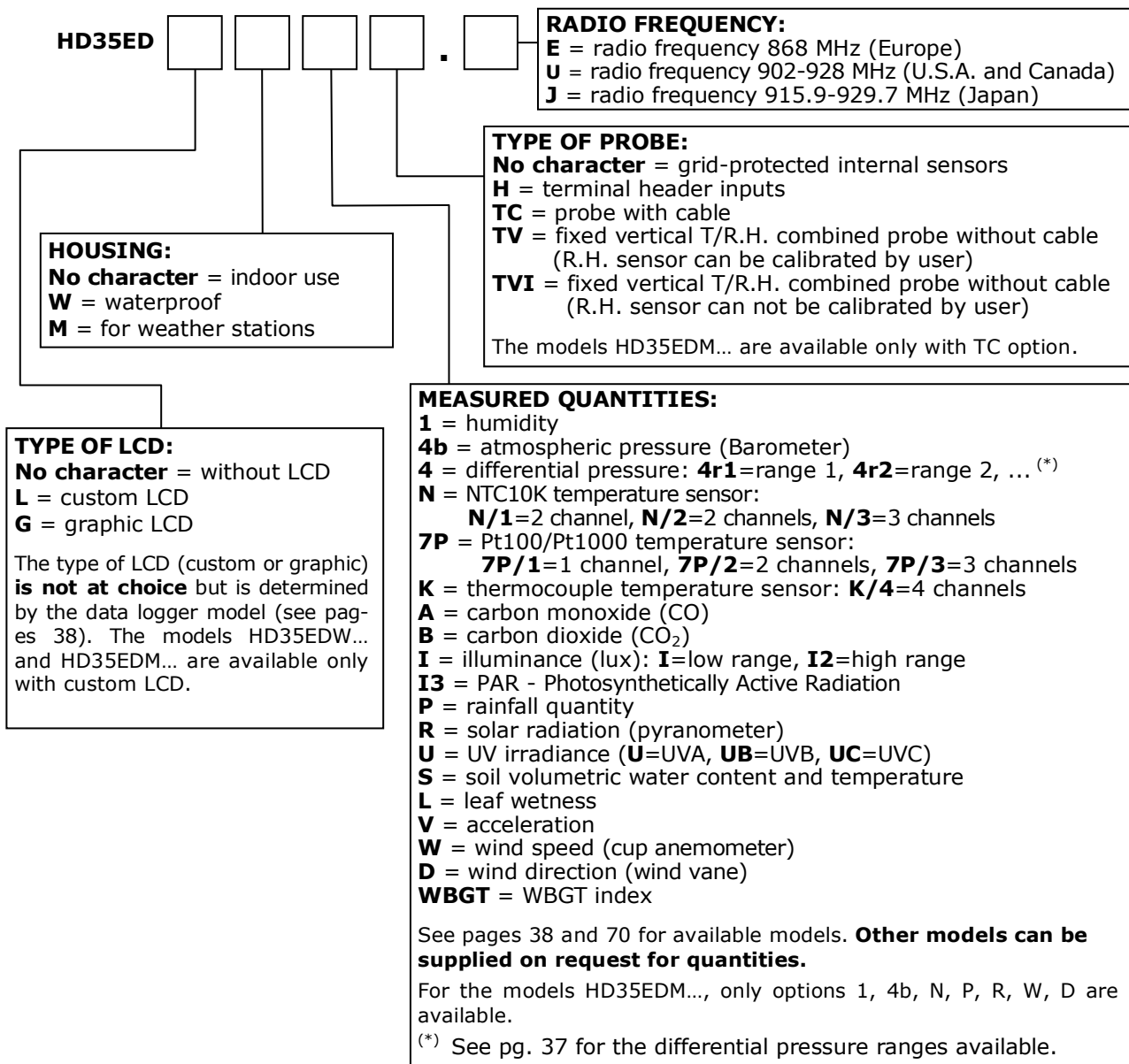

PROBES

TEMPERATURE AND RELATIVE HUMIDITY COMBINED PROBES

HP3517... Temperature and relative humidity combined probe. R.H. sensor measurement range: 0...100%. Temperature sensor: NTC10K Ω for HP3517TC..., Pt100 for HD3517ETC. NTC10K Ω sensor measurement range: -40...+105 °C. Pt100 sensor measurement range: -40...+150 °C. R.H. sensor operating temperature: -20...+80 °C standard, -40...+150 °C with **option E**. Diameter 14 mm. Cable length 2, 5 or 10 m standard. 4-pole M12 female connector.

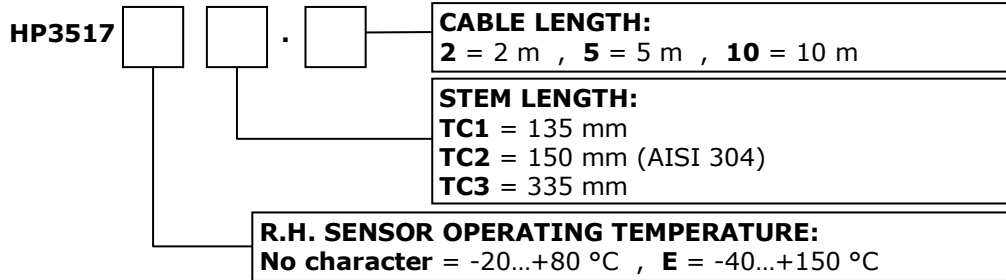

HD9007A-1 12-ring protection against solar radiations. Includes support bracket.

HD9007A-2 16-ring protection against solar radiations. Includes support bracket.

HD9007T26.2 Adapter for \varnothing 14 mm probes for protections against solar radiations HD9007A-1 and HD9007A-2.

Pt100 AND Pt1000 TEMPERATURE PROBES

TP35.1... Stainless steel temperature probe. 4-wire Pt1000 1/3 DIN sensor. Dimensions: \varnothing 5 x 40 mm. Cable length 3, 5 or 10 m standard. Cable ending with free wires or 4-pole M12 female connector. Operating temperature: -50...+105 °C.

TP35.2... Thermoplastic rubber temperature probe. 3-wire Pt1000 1/3 DIN sensor. Dimensions: \varnothing 5 x 20 mm. Cable length 3 or 5 m standard. Cable ending with free wires or 4-pole M12 female connector. Operating temperature: 0...+70 °C.

TP35.4... Stainless steel temperature probe. 4-wire Pt100 1/3 DIN sensor. Dimensions: \varnothing 6 x 50 mm. Cable length 3, 5 or 10 m standard. Cable ending with free wires or 4-pole M12 female connector. Operating temperature: -50...+105 °C.

TP35.5... Stainless steel penetration temperature probe. 3-wire Pt1000 1/3 DIN sensor. Dimensions: \varnothing 4 x 100 mm. Cable length 3 or 5 m standard. Cable ending with free wires or 4-pole M12 female connector. Operating temperature: -40...+300 °C.

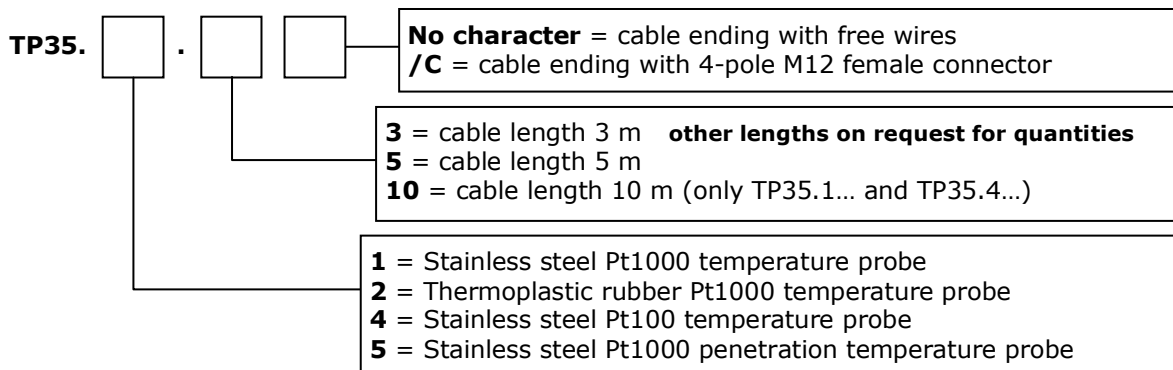

TP35878ISS.5 1/3 DIN Pt100 contact temperature probe for solar panel. Dimensions: \varnothing 30 mm. Cable length 5 m. Cable ending with 4-pole M12 female connector. Operating temperature: 0...+85 °C.

- TP35878ISS.10** 1/3 DIN Pt100 contact temperature probe for solar panel. Dimensions: Ø 30 mm. Cable length 10 m. Cable ending with 4-pole M12 female connector. Operating temperature: 0...+85 °C.
- TP35.5AF.5** Stainless steel temperature probe. 4-wire class A wire wound Pt100 sensor. Stem dimensions: Ø 3 x 60 mm. Cable length: 5 m. Cable termination: open wires. Shield: Inox + Teflon. Operating temperature: -110...+180 °C.
- TP35.5AF.5/C** Stainless steel temperature probe. 4-wire class A wire wound Pt100 sensor. Stem dimensions: Ø 3 x 60 mm. Cable length: 5 m. Cable termination: 4-pole M12 female connector. Shield: Inox + Teflon. Operating temperature: -110...+180 °C.
- TP35.5AF1.2** Stainless steel temperature probe. 4-wire class A wire wound Pt100 sensor. Stem dimensions: Ø 3 x 150 mm. Cable length: 2 m. Cable termination: open wires. Shield: Inox + Teflon.
- TP35.5AF1.2/C** Stainless steel temperature probe. 4-wire class A wire wound Pt100 sensor. Stem dimensions: Ø 3 x 150 mm. Cable length: 2 m. Cable termination: 4-pole M12 female connector. Shield: Inox + Teflon.

NTC 10KΩ @ 25 °C SENSOR TEMPERATURE PROBES

- HP3507TC...** Pocan (**TC1** and **TC3**) or AISI 304 (**TC2**) temperature probe. NTC 10KΩ @ 25 °C sensor. Diameter 14 mm. Stem length: 135 mm (**TC1**), 150 mm (**TC2**), 335 mm (**TC3**). Cable length 3, 5 or 10 m standard. 4-pole M12 female connector. Operating temperature: -40...+105 °C.
- TP35N1...** Stainless steel temperature probe. NTC 10KΩ @ 25 °C sensor. Dimensions: Ø 5 x 40 mm. Cable length 3, 5 or 10 m standard. Cable ending with free wires or 4-pole M12 female connector. Operating temperature: -20...+75 °C.
- TP35N2...** Stainless steel temperature probe. NTC 10KΩ @ 25 °C sensor. Dimensions: Ø 6 x 50 mm. Cable length 3, 5 or 10 m standard. Cable ending with free wires or 4-pole M12 female connector. Operating temperature: 0...+70 °C.
- TP35N5...** Stainless steel penetration temperature probe. NTC 10KΩ @ 25 °C sensor. Dimensions: Ø 4 x 100 mm. Cable length 3 or 5 m standard. Cable ending with free wires or 4-pole M12 female connector. Operating temperature: -20...+105 °C.
- TP35N6...** Environmental temperature probe, wall mounting with aluminum flange. NTC 10KΩ @ 25 °C sensor. Dimensions: 56 x 65 x 20 mm. Cable length 5, 10, 15 or 20 m. Cable ending with 4-pole M12 female connector. Operating temperature: -20...+70 °C.

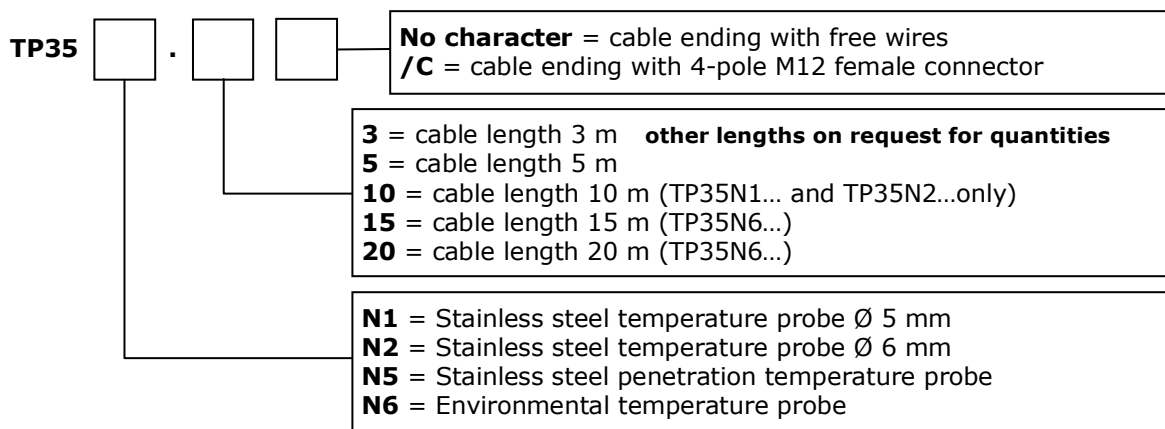

THERMOCOUPLE TEMPERATURE PROBES

- TP35K6.5** Stainless steel temperature probe. K-type thermocouple sensor with isolated junction. Cable length 5 m. Cable ending with free wires.

PHOTOMETRIC – RADIOMETRIC PROBES

LP 35 PHOT Photometric probe for measuring illuminance, CIE photopic filter, spectral response according to the standard photopic curve, diffuser for cosine correction. Measuring range: 0.1...200,000 lux. Cable length 5 m.

LP 35 PHOT03BL Photometric probe for measuring illuminance, CIE photopic filter, spectral response according to the standard photopic curve, diffuser for cosine correction, K5 dome. Measuring range: 0.1...200,000 lux. **The cable (CPM12 AA4...D) has to be ordered separately.**

LP 35 P-A Combined probe with two sensors for measuring illuminance, with standard photopic spectral response, and irradiance in the **UVA** spectral range 315 nm...400 nm, diffuser for cosine correction. Illuminance measuring range: 0.3...20.000 lux. Irradiance measuring range: 1...10.000 mW/m². Cable length 5 m.

LP 35 UVA Radiometric probe for measuring irradiance in the **UVA** spectral range 315 nm...400 nm, diffuser for cosine correction. Measuring range: 1...10.000 mW/m². Cable length 5 m.

LP 35 UVB Radiometric probe for measuring irradiance in the **UVB** spectral range 280 nm...315 nm, diffuser for cosine correction. Measuring range: 1·10⁻³...100 W/m². Cable length 5 m.

LP 35 UVC Radiometric probe for measuring irradiance in the **UVC** spectral range 220 nm...280 nm, diffuser for cosine correction. Measuring range: 1·10⁻³...100 W/m². Cable length 5 m.

LP 35 PAR Radiometric probe for measuring **photons flow** in the field of photosynthesis of chlorophyll (PAR). Cosine correction. Measuring range 0...5000 μmol m⁻²s⁻¹. Cable length 5 m. M12 connector.

LP BL Base with level. On request, to be assembled to the probe upon ordering. For photometric and radiometric probes.



LP BL3 Adjustable wall support for Ø 30 mm photometric and radiometric probes.



PYRANOMETERS

LP PYRA 02 **First Class** pyranometer according to ISO 9060. Output in μV/(Wm⁻²). Supplied with: shade disk, cartridge with silica-gel crystals, 2 spare sachets, levelling device, connector and calibration report. **On request 5 or 10 m cables with 4-pole M12 connectors.**

LP PYRA 03 **Second Class** pyranometer according to ISO 9060. Output in μV/(Wm⁻²). Supplied with levelling device and calibration report. **On request shade disk and 5 or 10 m cables with 4-pole M12 connectors.**

LP SILICON-PYRA 04 Pyranometer with silicon photodiode for measuring the **global solar irradiance**, diffuser for cosine correction. Spectral range 350...1100 nm. Typical sensitivity: 10 μV/W m⁻². Measuring range: 0...2000 W/m². Fixed cable 5 m long.

LP SP2 Shade disk for LP PYRA 03.

LP S1 Attachment bracket for LP PYRA 02, suitable for mast Ø 40 ÷ 50 mm.

LP S3 Attachment bracket for LP PYRA 03, suitable for mast Ø 40 ÷ 50 mm.

RAIN GAUGES

- HD2013** Rain gauge with tipping bucket, area 400 cm², for temperature range +4 °C...+60 °C. Standard resolution 0.2 mm. On request when placing the order resolution 0.1 or 0.5mm. Output contact normally closed.
- HD2013R** Rain gauge with tipping bucket, area 400 cm², equipped with heater for temperature range -20 °C...+60 °C. Standard resolution 0.2 mm. On request when placing the order resolution 0.1 or 0.5mm. Output contact normally closed. Power voltage 12 Vdc or 24 Vdc ± 10% / power absorption 165 W.
- HD2015** Rain gauge with tipping bucket, area 200 cm², for temperature range +4 °C...+60 °C. Standard resolution 0.2 mm. On request when placing the order resolution 0.1 or 0.5mm. Output contact normally closed.
- HD2015R** Rain gauge with tipping bucket, area 200 cm², equipped with heater for temperature range -20 °C...+60 °C. Standard resolution 0.2 mm. On request when placing the order resolution 0.1 or 0.5mm. Output contact normally closed. Power voltage 12 Vdc or 24 Vdc ± 10% / power absorption 50 W.
- HD2013.18** Bird dissuader.
- HD2013.5K** Kit of accessories for the installation of the HD2013 rain gauge raised 500 mm off the ground.
- HD2013.5K.1** Kit of accessories for the installation of the HD2013 rain gauge raised 1 m off the ground.
- HD2015.5K** Kit of accessories for the installation of the HD2015 rain gauge raised 500 mm off the ground.
- HD2015.5K.1** Kit of accessories for the installation of the HD2015 rain gauge raised 1 m off the ground.
- HD2003.75** Base for 40 mm diameter mast, with tip to be driven into the ground.
- HD2003.78** Base for 40 mm diameter mast, to be fixed to the floor.

WIND SPEED AND DIRECTION SENSORS

- HD54.3** Passive cup anemometer. Measuring range: 1...65 m/s. Operating conditions: -40...+60 °C / 0...100% RH. Rod mounting. Height 81 mm assembled.
- HD54.D** Wind direction vane probe. Measuring range: 0...360°. Dead band: typical 4°, maximum 8°. Threshold: 1 m/s. Operating conditions: -40...+60 °C / 0...100% RH. Rod mounting. Dimensions: 210 x 120 mm.

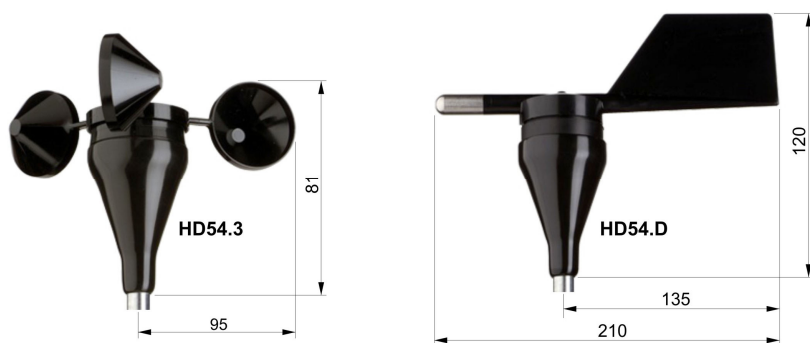

HD54.9K

Transverse mast kit including: transverse mast \varnothing 40 mm and L=1500 mm, two extension bars \varnothing 40 mm and accessories.

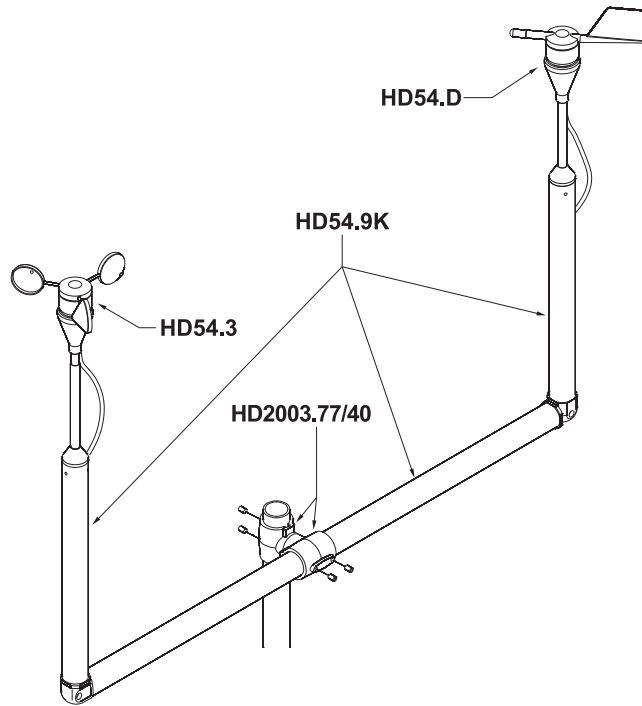

LEAF WETNESS SENSORS

HD3501.5

Leaf wetness sensor with double sensitive surface. IP 67 protection degree. 5 m cable ending with M12 connector.

HD3501.10

Leaf wetness sensor with double sensitive surface. IP 67 protection degree. 10 m cable ending with M12 connector.

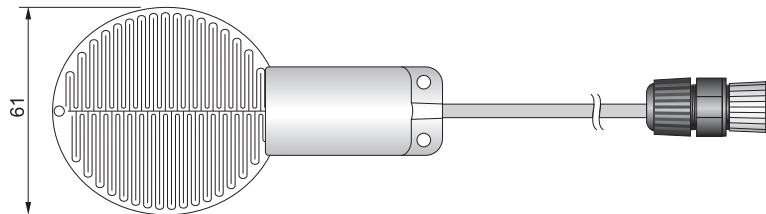

SOIL VOLUMETRIC WATER CONTENT SENSORS

HD3510.1.5

2-electrode probe for measuring the soil volumetric water content. With integrated NTC 10 k Ω temperature sensor. M12 connector. 5 m cable.

HD3510.1.10

2-electrode probe for measuring the soil volumetric water content. With integrated NTC 10 k Ω temperature sensor. M12 connector. 10 m cable.

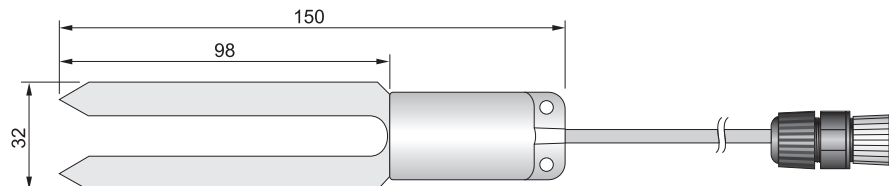

- HD3510.2.5** 3-electrode probe for measuring the soil volumetric water content in restricted volumes. With integrated NTC 10 k Ω temperature sensor. M12 connector. 5 m cable.
- HD3510.2.10** 3-electrode probe for measuring the soil volumetric water content in restricted volumes. With integrated NTC 10 k Ω temperature sensor. M12 connector. 10 m cable.

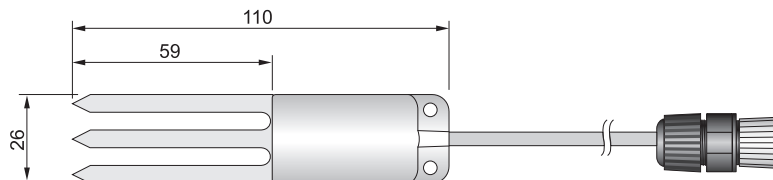

ACCESSORIES

- HD35AP-S** Additional copy of HD35AP-S basic software CD-ROM for system configuration, real-time measurement display and data download. Access to data is allowed only from the PC where the database is installed. For Windows® operating systems.
- HD35AP-PLUS** Advanced version of the HD35AP-S software that provides **full FTP functionality** and **multi-client connection to the Database** (access to the Database from all the PCs connected in the network to the server where the Database is installed). For Windows® operating systems.
- HD35AP-CFR21** Advanced version of the HD35AP-S software including, **in addition to the features of the PLUS option**, the management of the data logging system in accordance with the **FDA 21 CFR part 11 recommendations**. For Windows® operating systems.
- CP23** Direct USB connection cable with mini-USB male connector on the instrument side and A-type USB male connector on the PC side.
- CPM12-8P.2** 8-pole cable. Length 2 m. 8-pole M12 connector on one side, free wires on the other. For RS485 connection to HD35APS base unit.
- CPM12-8P.5** 8-pole cable. Length 5 m. 8-pole M12 connector on one side, free wires on the other. For RS485 connection to HD35APS base unit.
- CPM12-8P.10** 8-pole cable. Length 10 m. 8-pole M12 connector on one side, free wires on the other. For RS485 connection to HD35APS base unit.
- CPM12 AA4.2** 4-pole cable. Length 2 m. 4-pole M12 connector on one side, free wires on the other.
- CPM12 AA4.5** 4-pole cable. Length 5 m. 4-pole M12 connector on one side, free wires on the other.
- CPM12 AA4.10** 4-pole cable. Length 10 m. 4-pole M12 connector on one side, free wires on the other.
- CPM12 AA4.20** 4-pole cable. Length 20 m. 4-pole M12 connector on one side, free wires on the other.
- CPM12 AA4.2D** 4-pole cable. Length 2 m. 4-pole M12 connector on both sides.
- CPM12 AA4.5D** 4-pole cable. Length 5 m. 4-pole M12 connector on both sides.
- CPM12 AA4.10D** 4-pole cable. Length 10 m. 4-pole M12 connector on both sides.
- CPM12 AA4.20D** 4-pole cable. Length 20 m. 4-pole M12 connector on both sides.
- SWD06** 100-240 Vac / 6 Vdc - 1 A mains power supply.
- HD35.03** Plastic support for removable installation of base units, repeaters and data loggers in indoor-use housing.

HD35.11K	Pair of flanges in anodized aluminum alloy for fixed installation of base units, repeaters and data loggers in indoor-use housing. Lock pin and pad-lock included.
HD35.24W	Flange in anodized aluminum alloy for fixing to the wall the models HD35EDW... in waterproof housing (versions L=80 mm, H=120 mm).
HD35.37	Pair of flanges in anodized aluminum alloy for fixing to the wall the models HD35EDW... in waterproof housing (versions L=120 mm, H=80 mm).
HD35-ANT	Spare external RF antenna for the base units HD35AP... and the repeater HD35RE (not for HD35REW).
HD35-ANTW	Spare external RF antenna for the repeater HD35REW and the data loggers HD35EDW... with external antenna.
HD35-BAT1	Lithium-ion rechargeable 3.7 V battery, capacity 2250 mA/h, JST 3-pole connector. For HD35AP... base units and HD35RE repeater.
HD35-BAT2	Lithium Thionyl Chloride (Li-SOCl ₂) non rechargeable 3.6 V battery, size AA, Molex 5264 2-pole connector. For HD35ED... data loggers and HD35ED-ALM alarm module.
BAT-2013DB	3.6 V lithium-thionyl chloride (Li-SOCl ₂) not rechargeable battery, size C, 2-pole Molex 5264 connector. For the repeater HD35REW and the data loggers HD35EDWK/4TC, HD35EDWH and HD35EDM....
HD2003.77/40	Clamping for fixing the waterproof housing to the 40 mm diameter mast.
HD2003.71K	40 mm diameter mast kit, 2 m high, in two pieces.
HD2003.75	Base for 40 mm diameter mast, with tip to be driven into the ground.
HD2003.78	Base for 40 mm diameter mast, to be fixed to the floor.
HD2003.75K	Mast bracing kit, for ground installation, fixing diameter 2m. Stainless steel string.
HD2003.78K	Mast bracing kit, for floor installation, fixing diameter 2m. Stainless steel string.
HD2003.2.14	Three sectors flange for Ø 40 mm tube, 6 inputs Ø 16 mm.
HD2005.20	Anodized aluminum tripod kit with adjustable legs for installing environmental sensors. Height 2 m. It can be fixed on a flat base with screws or to the ground with pegs.
HD2005.20.1	Anodized aluminum tripod kit with adjustable legs for installing environmental sensors. Height 3 m. It can be fixed on a flat base with screws or to the ground with pegs.
HD9217TF1	Protection shield against solar radiations for outdoor installation. For waterproof HD35EDW... data loggers (housing H=120 mm x L=80 mm).
HD32MT4.6	Protection shield against solar radiations for outdoor installation. For HD35EDM... data loggers (housing H=120 mm x L=122 mm) and HD35EDW... (housing H=80 mm x L=120 mm).

Accessories for humidity probes

HD75	Saturated solution to check Relative Humidity probes at 75 % RH, includes ring adapter for 14 mm diameter probes, thread M12×1.
HD33	Saturated solution to check Relative Humidity probes at 33 % RH, includes ring adapter for 14 mm diameter probes, thread M12×1.

Accessories for CO and CO₂ sensors

- MINICAN.12A** Nitrogen bottle for CO calibration at 0 ppm. Volume 20 liters. **With adjustment valve.**
- MINICAN.12A1** Nitrogen bottle for CO calibration at 0 ppm. Volume 20 liters. **Without adjustment valve.**
- HD37.36** Connection tube kit between instrument and MINICAN.12A for CO calibration.
- HD37.37** Connection tube kit between instrument and MINICAN.12A for CO₂ calibration with the nitrogen can. Only for the models HD35EDW... in waterproof housing.
- HD31.B3A** Adapter for the calibration of the CO₂ sensor with the nitrogen can. Only for the models HD35EDW... in waterproof housing.

DELTA OHM metrology laboratories LAT N° 124 are accredited by ACCREDIA for Temperature, Humidity, Pressure, Photometry / Radiometry, Acoustics and Air Velocity. They can supply calibration certificates for the accredited quantities.

NOTE

Approvals

Sub-GHz certifications:

Models HD35...**U** contain transmitter module FCC ID: X7J-A10040601
IC ID: 8975A-A10040601

Models HD35...**J** contain TELEC certified RF module: [R] 010-100130



IEEE 802.11 (Wi-Fi) certifications:

Models HD35APW.**E** and HD35APW.**U** contain IEEE 802.11b/g module FCC ID: XM5-SM2144SMT
IC ID: 8516A- SM2144SMT

Model HD35APW.**J** contains IEEE 802.11b/g/n module FCC ID: XM5-SMG2N2
IC ID: 8516A- SMG2N2
TELEC certified RF module: [R] 204-520077



FCC and IC notices

Notice: This device complies with Part 15 -15.247(a2) and 15.247(b) and 15.249 of the FCC Rules and with Industry Canada (IC) licence-exempt RSS standard(s). Operation is subject to the following two conditions: (1) this device may not cause harmful interference, and (2) this device must accept any interference received, including interference that may cause undesired operation.

Avis: *Cet appareil est conforme avec Part 15 -15.247(a2) et 15.247(b) et 15.249 des règlements FCC et Industrie Canada (IC) RSS standard exempts de licence(s). Son fonctionnement est soumis aux deux conditions suivantes: (1) cet appareil ne peut pas provoquer d'interférence et (2) cet appareil doit accepter toute interférence, y compris les interférences qui peuvent causer un mauvais fonctionnement du dispositif.*

Notice: This equipment has been tested and found to comply with the limits for Class B digital device, pursuant to part 15 of the FCC Rules. These limits are designed to provide reasonable protection against harmful interference in a residential installation. This equipment generates, uses and radiates radio frequency energy, and, if not installed and used in accordance with the instructions, may cause harmful interference to radio communications. However, there is no guarantee that interference will not occur in a particular installation. If this equipment does cause harmful interference to radio or television reception, which can be determined by turning the equipment off and on, the user is encouraged to try to correct the interference by one or more of the following measure:

- Reorient or relocate the receiving antenna.
- Increase the separation between the equipment and receiver.
- Connect the equipment into an outlet on a circuit different from that to which the receiver is connected.
- Consult the dealer or an experienced radio/TV technician for help.

Notice: To satisfy FCC/IC RF exposure requirements for mobile and base station transmission devices, a separation distance of 20 cm or more should be maintained between the antenna of this device and persons during operation. To ensure compliance, operation at closer than this distance is not recommended. The antenna(s) used for this transmitter must not be co-located or operating in conjunction with any other antenna or transmitter.

Avis: *Pour répondre aux exigences d'exposition RF FCC/IC pour les dispositifs de transmission mobiles et les stations de base, une distance de séparation de 20 cm ou plus doit être maintenue entre l'antenne de l'appareil et des personnes en cours de fonctionnement. Pour assurer la conformité, l'exploitation de plus près à cette distance n'est pas recommandée. L'antenne(s) utilisé pour cet émetteur ne doit pas être co-localisés ou fonctionner conjointement avec une autre antenne ou transmetteur.*

Notice: Under Industry Canada regulations, this radio transmitter may only operate using an antenna of a type and maximum (or lesser) gain approved for the transmitter by Industry Canada. To reduce potential radio interference to other users, the antenna type and its gain should be so chosen that the equivalent isotropically radiated power (e.i.r.p.) is not more than that necessary for successful communication.

Avis: *Conformément à la réglementation d'Industrie Canada, le présent émetteur radio peut fonctionner avec une antenne d'un type et d'un gain maximal (ou inférieur) approuvé pour l'émetteur par Industrie Canada. Dans le but de réduire les risques de brouillage radioélectrique à l'intention des autres utilisateurs, il faut choisir le type d'antenne et son gain de sorte que la puissance isotrope rayonnée équivalente (p.i.r.e.) ne dépasse pas l'intensité nécessaire à l'établissement d'une communication satisfaisante.*



Dichiarazione di conformità UE
EU declaration of conformity

Prodotto: Sistema di datalogging wireless serie HD35...
Product: HD35... series wireless data logging system

Accessori: Sonde di temperatura, umidità relativa, luce
Accessories: Temperature, relative humidity, light probes

Fabbricante:

Manufacturer:

Delta Ohm S.r.l. a socio unico
via G. Marconi 5
35030 Caselle di Selvazzano (PD)
ITALY

La presente dichiarazione di conformità è rilasciata sotto la responsabilità esclusiva del fabbricante.

This declaration of conformity is issued under the sole responsibility of the manufacturer.

L'oggetto della dichiarazione di cui sopra è conforme alla pertinente normativa di armonizzazione dell'Unione:

The object of the declaration described above is in conformity with the relevant Union harmonisation legislation:

Radio Equipment Directive 2014/53/EU
RoHS Directive 2011/65/EU

Pertinenti norme armonizzate utilizzate:

Relevant harmonised standards used:

EN 61010-1:2010
EN 61326-1:2013
EN 62479:2010
ETSI EN 300 220-1 V2.4.1
ETSI EN 300 220-2 V2.4.1
ETSI EN 301 489-1 V1.9.2
ETSI EN 301 489-3 V1.6.1
EN 50581:2012

Firmato a nome e per conto di:

Signed for and on behalf of:

Delta Ohm S.r.l. a socio unico

Caselle di Selvazzano (PD) – 2016-06-13

Luisa Masut – CEO

GUARANTEE



TERMS OF GUARANTEE

All DELTA OHM instruments are subject to accurate testing, and are guaranteed for 24 months from the date of purchase. DELTA OHM will repair or replace free of charge the parts that, within the warranty period, shall be deemed non efficient according to its own judgement. Complete replacement is excluded and no damage claims are accepted. The DELTA OHM guarantee only covers instrument repair. The guarantee is void in case of incidental breakage during transport, negligence, misuse, connection to a different voltage than that required for the appliance by the operator. Finally, a product repaired or tampered by unauthorized third parties is excluded from the guarantee. The instrument shall be returned FREE OF SHIPMENT CHARGES to your dealer. The jurisdiction of Padua applies in any dispute.



The electrical and electronic equipment marked with this symbol cannot be disposed of in public landfills. According to the Directive 2011/65/EU, the european users of electrical and electronic equipment can return it to the dealer or manufacturer upon purchase of a new one. The illegal disposal of electrical and electronic equipment is punished with an administrative fine.

This guarantee must be sent together with the instrument to our service centre.
IMPORTANT: Guarantee is valid only if coupon has been correctly filled in all details.

Instrument Code: **HD35... series**

Serial Number _____

RENEWALS

Date _____

Date _____

Inspector _____

Inspector _____

Date _____

Date _____

Inspector _____

Inspector _____

Date _____

Date _____

Inspector _____

Inspector _____

