

# **HD2030**

**ENGLISH**

The quality level of our instruments is the result of a continuous product development. This can lead to differences between what is written in this manual and the tool that you purchased. We cannot completely rule out errors in the manual, we apologize for this inconvenient.  
The data, pictures and descriptions, contained in this document, cannot be legally enforced. We reserve the right to make changes and corrections without notice.

# Vibration Analyzer HD2030

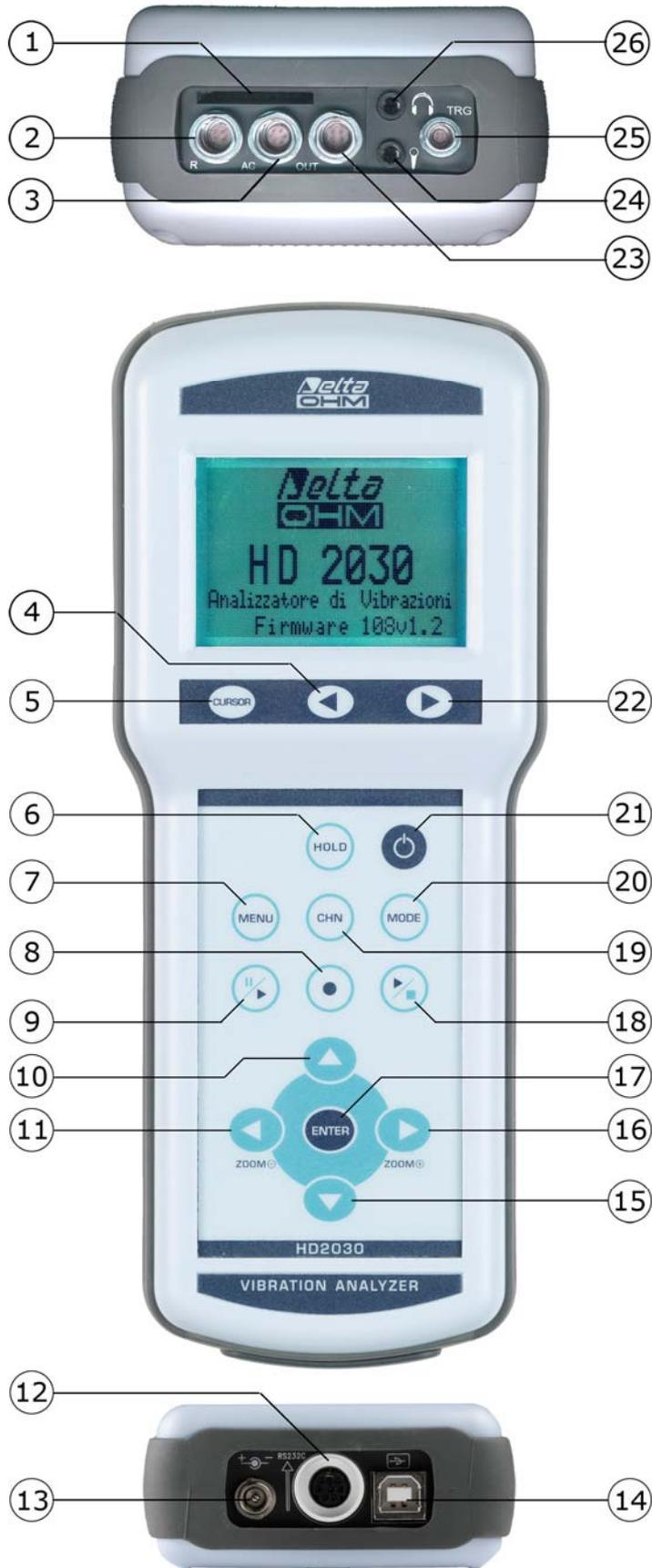

## CONNECTORS AND KEYBOARD

The tool is endowed with keyboard with 13 keys, six connectors on the top and three connectors on the bottom. On the top there is also the memory card slot.

With reference to the figure at page 2 there are:

- 1 Slot for SD memory card with a maximum size of 2GB.
- 2 4 poles LEMO-B type connector for the connection of a **triaxial** or **monoaxial accelerometer** with integrated electronics (type IEPE or compatible).
- 3 6 poles LEMO-B type connector for the analog outputs (**LINE**) of the 4 input channels.
- 4 **LEFT** arrow key on the keypad: in the graphic mode it moves left the cursor or the two active cursors (blinking). In VLM mode it allows to scroll the VLM\_1, ..., VLM\_4 screens. In the spectrum mode, it allows to switch from acceleration viewing to speed and displacement viewings.
- 5 **CURSOR** key on the keypad: in graphic mode it allows to select one of the two cursors or both of them. Holding pressed the CURSOR key for at least 2 seconds when the third-octave spectrum is displayed, the *limit acceleration curve* tracking is activated.
- 6 **HOLD** key: it temporarily stops the display update.
- 7 **MENU** key: it allows to access the configuration menu and the programs list. With the same key, the menu is exited to go back to the measure mode.
- 8 **REC** (recording) key: in combination with START / STOP / RESET, it activates the continuous data recording in the memory. If it is hold pressed for at least 2 seconds, it is possible to memorize what it is displayed as single record or to start the vocal recording.
- 9 **PAUSE/CONTINUE** key: to put in pause mode the integrated measures. From PAUSE mode, press the same key to start again the integrated measures. In PAUSE mode, the measures are reset if the START / STOP / RESET key is pressed.
- 10 **UP** arrow key: in menu mode, it selects the previous row or increases the selected parameter. In VLM screen, it adjusts the boundaries of the horizontal bar. In graphical mode it decreases the initial and final levels of the vertical scale; in this way, the graph is moved upward.
- 11 **LEFT** arrow key: in menu mode, it is used to edit the parameters with attribute. In VLM screen, it changes the measure unit. In graphic mode, it compresses the vertical scale.
- 12 **MiniDin** type connector for RS232C serial port. For the connection to a PC RS232 port or to the HD40.1 printer, it is necessary to use the adequate null-modem serial cable (HD2110CSNM code), provided with a D-sub 9 poles connector.
- 13 Male connector for **external power supply** ( $\varnothing$  5.5mm-2.1mm socket). It requires a 9...12Vdc/300mA power supply. The power supply positive pole must be connected to the central pin.
- 14 **USB** connector type B to connect the vibration analyzer to the USB port of a PC using a standard USB cable with type A and B connectors (CP22 code).
- 15 **DOWN** arrow key: in menu mode, it selects the subsequent row or decreases the selected parameter. In VLM screen, it changes the limits of the horizontal bar. In graphic mode, it increases the initial and final levels of the vertical scale; in this way, the graph is moved downward.
- 16 **RIGHT** arrow key: in menu mode, it is used to edit the parameters with attribute. In graphic mode, it expands the vertical scale. In the VLM screen, it changes the measure unit.
- 17 **ENTER** key: it confirms the insertion of the data or the modification of a parameter.
- 18 **START/STOP/RESET** key: if pressed in STOP mode, it starts the measurements (RUN mode). In RUN mode, it stops the measurements. If pressed in PAUSE mode, it resets the values of the integrated measures like Aeq, MAX/MIN levels, etc ...
- 19 **CHN** key: it selects the four measuring channels CH1, ..., CH4 (circular scrolling).
- 20 **MODE** key: it selects in a circular sequence the different instrument visualizing modes: VLM, timing profile, octave or third-octave spectra, distribution of probability and percentile levels.
- 21 **ON/OFF** key: to turn on and shutdown the instrument.
- 22 **RIGHT** arrow key on keypad: it moves right the cursor or the two active cursors (blinking). In VLM mode, it allows to scroll the VLM\_1, ..., VLM\_4 screens. In the spectrum mode, it allows to switch from acceleration viewing to speed and displacement viewings.
- 23 4 poles LEMO-B type connector for the connection of a **monoaxial accelerometer** with an integrated electronics (type IEPE or compatible).
- 24 3.5 mm jack connector for the connection of a microphone for vocal recordings.
- 25 4 poles LEMO-00 type connector for the trigger output.
- 26 3.5 mm jack for the connection of headphones.

# CERTIFICATO DI CONFORMITÀ DEL COSTRUTTORE

MANUFACTURER'S CERTIFICATE OF CONFORMITY

rilasciato da  
*issued by*

**DELTA OHM SRL STRUMENTI DI MISURA**

**DATA** 2014/06/11  
*DATE*

Si certifica che gli strumenti sotto riportati hanno superato positivamente tutti i test di produzione e sono conformi alle specifiche, valide alla data del test, riportate nella documentazione tecnica.

*We certify that below mentioned instruments have been tested and passed all production tests, confirming compliance with the manufacturer's published specification at the date of the test.*

Le misure effettuate presso un Laboratorio di Taratura Accredia sono garantite da una catena di riferibilità ininterrotta, che ha origine dalla taratura dei campioni di prima linea del Laboratorio presso l'istituto metrologico nazionale.

*Measurements performed in an Accredia Calibration Laboratory are guaranteed by a uninterrupted reference chain which source is the calibration of the Laboratory first line standards at the national metrological institute.*

**Tipo Prodotto:** **Vibration Analyzer**  
*Product Type:* *Analizzatore di vibrazioni*

**Nome Prodotto:** **HD2030**  
*Product Name:*

**Responsabile Qualità**  
*Head of Quality*

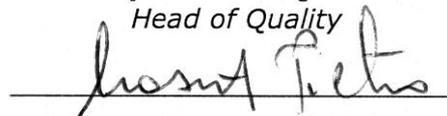

**DELTA OHM SRL**  
**35030 Caselle di Selvazzano (PD) Italy**  
**Via Marconi, 5**  
Tel. +39.0498977150 r.a. - Telefax +39.049635596  
Cod. Fisc./P.Iva IT03363960281 - N.Mecc. PD044279  
R.E.A. 306030 - ISC. Reg. Soc. 68037/1998

## INSTRUMENT OVERVIEW

### Block Diagram of HD2030

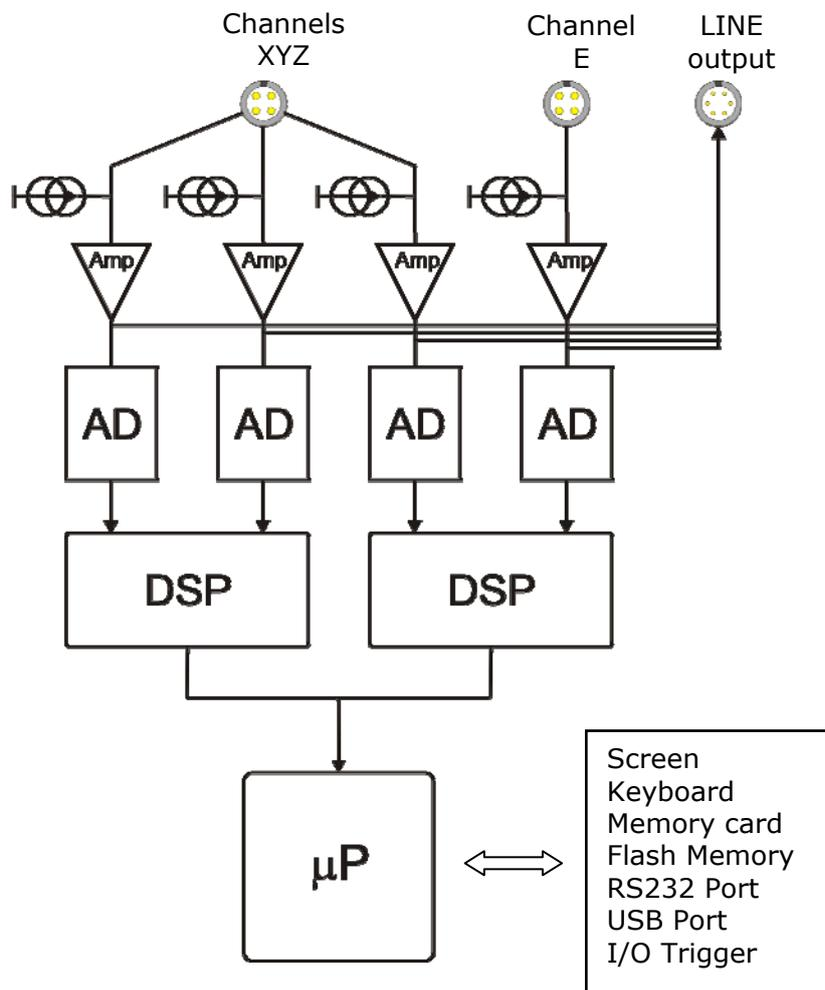

Block Diagram of the tool

The block diagram represents the main elements of the HD2030 vibration analyzer.

### Measure channels

HD2030 has four input channels polarized with direct current at 25V. It is possible to connect accelerometers with an amplifying integrated electronics IEPE (or similar) type that needs a maximum current of 2mA. **It's possible to connect to the RIGHT input a tri-axial type accelerometer or up to three monoaxial accelerometers; to LEFT input it's possible to connect a monoaxial type accelerometer.**

The amplified electrical signal of the four channels is sent to the LINE output.

### The instrument

The amplified signal of the four channels is converted into digital samples through as many 25-bit A/D converters and digitally elaborated by two DSP.

The weighted levels and the related spectra of each channel are then transferred from the DSP to the microprocessor that manages the display and the storage.

The microprocessor supervises all the instrument processes: the management of the calibration, the Flash memory and the memory card, the display, the keyboard and the serial multi-standard RS232C/USB interface.

## How to connect the accelerometers to the analyzer

The following diagram illustrates the different parts necessary to connect the accelerometers to the HD2030. The left input is monoaxial, the right input is triaxial.

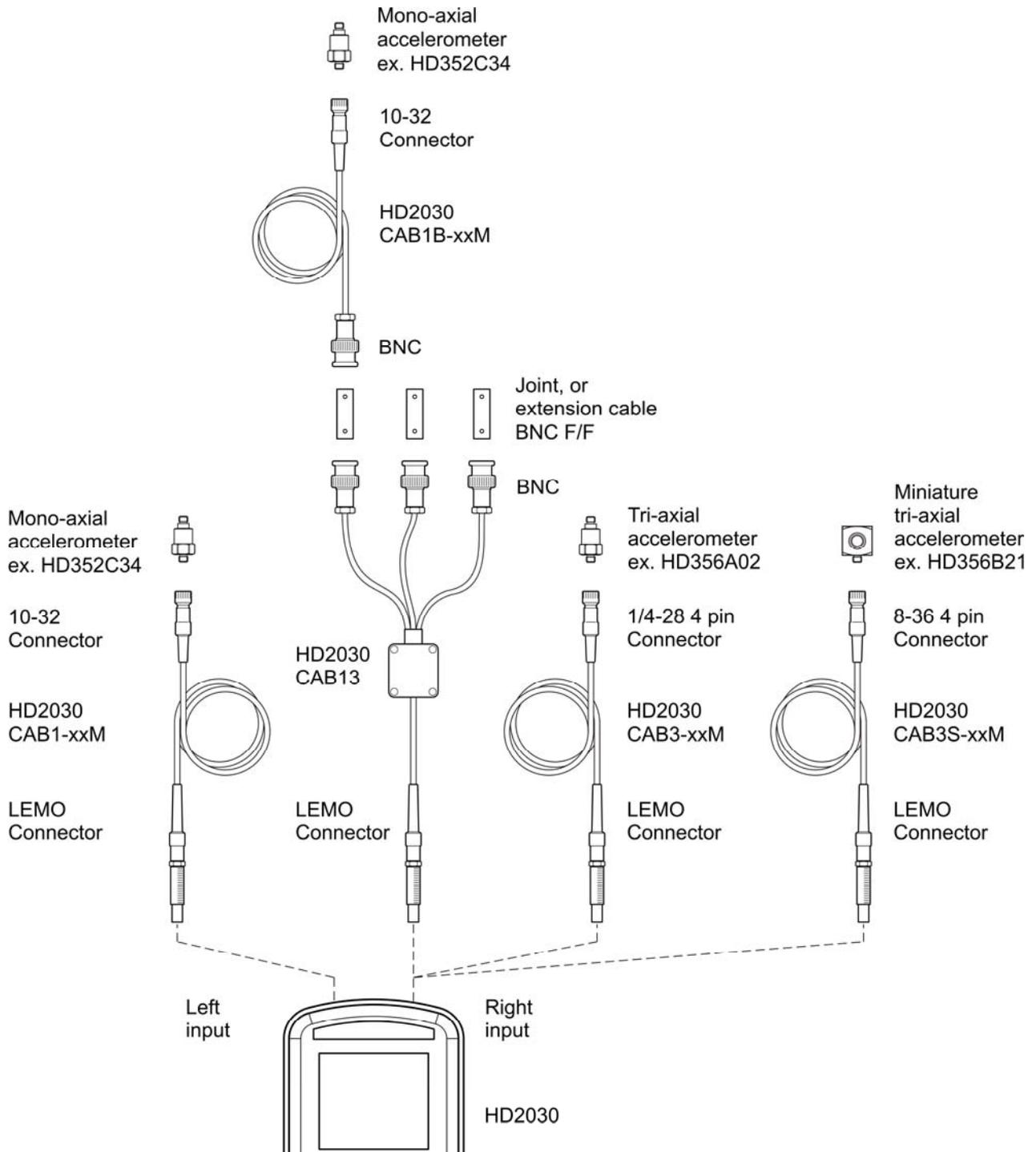

## INTRODUCTION

The HD2030 is a **portable vibration analyzer** able to perform spectral and statistical analysis. The instrument can supply all the measurement parameters required by the current normative concerning the **operators protection from the risk connected with the vibrations** and is able to measure in **hand-arm** and **whole body** modes. It is also possible to evaluate the **annoyance on persons due to vibration in buildings**.

The instrument has been designed mixing the easy to use concept with the maximum flexibility and the possibility to update the instrument with the evolving standards on vibrations. The firmware can be updated directly by the user through the supplied **Noise Studio software** (basic version).

HD2030 analyzer can perform all measurements requested by technical standards concerning workers protection from the risk of mechanical vibrations exposure.

The HD2030 complies with the specifications of ISO 8041 (2005) and ISO 5349-1 (2001 - vibrations transmitted to the hand-arm system) and ISO 2631-1,2 and 4 (1997 - vibrations transmitted to the whole body).

The octave and third-octave filters comply with the class 1 specifications of IEC 61260.

The HD2030 is a vibration analyzer suitable for the following applications:

- Evaluation of the exposure of operators to the risk connected with the vibrations transmitted to the hand-arm system through vibrating tools or items subjected to vibrations or impacts;
- Evaluation of the operator exposure to the risk connected with vibrations transmitted to the whole body also through the use of movement or transportation ways;
- Evaluation of the operator exposure to the risk connected with vibrations transmitted to the whole body by buildings subjected to vibrations or impacts;
- Octave or third-octave bands spectral analysis;
- Statistical analysis with calculation of the percentile levels from  $L_1$  to  $L_{99}$ ;
- Attenuation of vibrations and reclamations.

The HD2030 analyzer simultaneously acquires the **acceleration value in 4 channels** and calculates, **in parallel for all channels**, both the weighted acceleration values and the **octave or third-octave bands spectra**. In addition to the instant and average acceleration values, the analyzer also elaborates **peak levels, vibration dose (VDV) and crest factors**. The frequency weighting can be chosen freely according to the specific application.

The possibility to connect any type of accelerometer with integrated electronics (type IEPE or compatible), both **triaxial** and **monoaxial**, ensures the maximum ease of use and reduces the possibility of making mistakes or taking measures affected by electromagnetic interference or noise. The acquisition of the acceleration in 4 channels allows, for example, to make objective evaluation of the vibrations transmitted by a transportation way through to the driving seat or to evaluate, during the design and the production verification, the effectiveness of damping introduced by the suspension and by the absorbent material of the seat itself.

A versatile **data logging** function stores, both in the 8MB internal memory and in the memory card (SD up to 2GB), multiple profiles and spectra. Moreover it is possible to add to the profiles the accelerometers signals recording directly the digital samples. When analyzing the memorized data, it is then possible to examine the signals provided by the accelerometers and calculate additional parameters or verify the absence of source of errors such as those due to the DC-shift phenomenon. Each recording can be associated with a **vocal comment**. Using the available audio channel, it is possible to record an audio signal up to one hour, as a further opportunity to document the measures.

The performed recordings can be reviewed using the provided **"Memory Navigator"** program of the HD2030 analyzer. The vocal comments associated with the recordings can be listened using the appropriate headphones output.

Simultaneously to the acquisition of the profiles, it is performed the **octave or third-octave bands real time spectral analysis**. The vibration analyzer calculates the spectrum of the sound signal every second and integrates it linearly up to 99 hours. It is also possible to associate with the spectrum a frequency weighted measurement parameter whose value is calculated from the acceleration values of each octave or third-octave spectrum band. In addition to the acceleration values for each band of the spectrum, it is possible to display the speed or displacement value.

The choice to measure hand-arm (HA) or whole-body (WB and BV) modify the extension of the spectral analysis: while for the hand-arm measures the frequency range extends from 3.15Hz to 3.15kHz (from 4Hz to 2kHz octave band spectrum), for whole-body measurements the range of the central frequency is shifted towards low frequencies from 0.315Hz to 315Hz (from 0.5Hz to 250Hz in octave bands) .

As **statistical analyzer**, the HD2030 calculates the probability distribution of a measurement parameter at choice and analyzes it in classes of 1dB. In addition to the chart of probability distribution, it is also supplied the graph with percentile levels from  $L_1$  to  $L_{99}$ .

The LINE type not weighted **analog outputs** allows to record, for subsequent analysis, the accelerometers signal on a tape or directly in a PC with an acquisition board.

The **calibration** can be done using the accelerometers calibration data or using a vibrations generator able to produce a known and stable acceleration. A reserved and protected area in the permanent memory is used to record the last 120 calibrations performed. The supplied Noise Studio interface software allows to control the instrument and accelerometers and to document the measurements by downloading automatically the register file of the instrument calibrations.

In order to easily carry out the different measurements on the field, in the HD2030 it is possible to store up to **10 customizable and editable setups**, also using the Noise Studio software. A title is associated with each setup in order to easily choose the desired one.

Considering that in order to measure in every possible situation it is necessary to use different types of accelerometers, up to **9 different sensor configurations** both for the right channel (triaxial) and for the left channel (monoaxial) can be selected based on the requirements. The sensors calibrations and configurations files are associated with the analyzer setups, so that, by choosing one of the stored setups, the sensors to be connected to the input channels are indicated and the last associated calibration values are automatically uploaded.

To simplify the reading of the data on the display, it is possible to disable one of the two inputs or the single measurement channel.

The check of the vibration analyzer functionality can be done directly by the user, in the field, thanks to a **diagnostic program**.

HD2030 can be completely **controlled by a PC** through the RS232 and USB serial interfaces, using an adequate communication protocol.

The **Noise Studio** interface software allows to download and display data stored in the instrument, to handle the files related to setups, calibrations and configurations. With the software it is possible to load in the analyzer up to 10 different setups, chosen among the available ones. The file related to calibrations is downloaded at every connection and it is saved together with the measurement data. The different sensors configurations can be programmed through the PC, both inserting manually the accelerometers data and also using the proper CD-ROM associated with the accelerometers that can be supplied by Delta Ohm together with the instrument.

## DESCRIPTION OF DISPLAY MODES

The acceleration values and the calculations made by the HD2030 analyzer are presented in **5 different screens**. The instrument analyzes simultaneously the acceleration signals on 4 axis associated with four measurement channels (CH1,..., CH4.). It is possible, in each screen, to choose the channel to display by simply pressing the **CHN** key.

When the instrument is **switched on**, it briefly shows the Delta Ohm logo and the program version. Then it is requested the selection of the configuration for the sensors connected to the two inputs: first the right triaxial input, than the left monoaxial one.

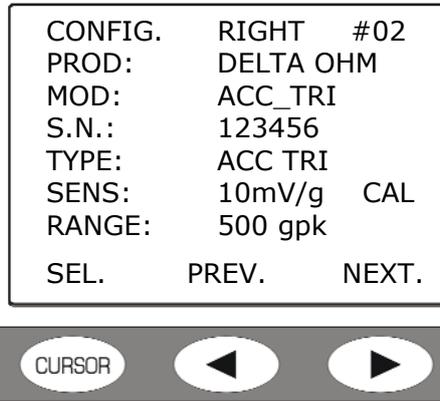

For both inputs, press **PREV** or **NEXT** to scroll the memorized sensor list, **SEL** to confirm.

Then, the instrument enters the VLM (Vibration Level Meter) mode, displaying in numerical form 3 instant or integrated measurement parameters.

The selection of the #00 (zero) configuration disables the corresponding input: if the right input is disabled, CH1, CH2 and CH3 channels do not appear. If it is disabled the left input, the CH4 channel does not appear.

If there is an external memory card, after the initial screen, the configuration files are loaded and the following screen appears:

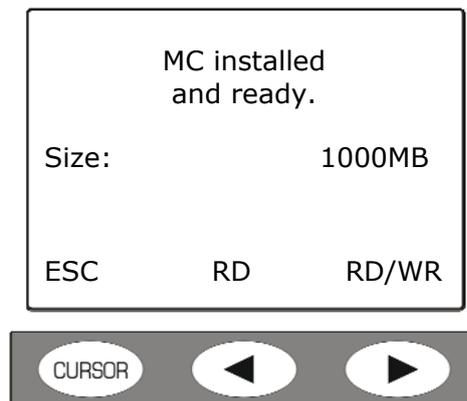

Press **RD/WR** to enable all the reading and writing functions and continue with the selection of the configurations.

Now the instrument is ready for the use (for the details about the sensors setup, see the **SENSORS SETUP** program description).

## The possible screen modes are:

- **VLM (Vibration Level Meter)**: divided into four screens with three measurement parameters each. The values displayed in numerical form are updated every second.
  - **VLM\_1**: 3 profiles of instant or integrated measurement parameters calculated on each of the four channels;
  - **VLM\_2**: 3 profiles of instant or integrated measurement parameters calculated on the vector built with the data of the first three channels (RIGHT input);
  - **VLM\_3**: 3 parameters integrated in all the measurement time and calculated on each of the four channels;
  - **VLM\_4**: 3 parameters integrated on all the measurement time and calculated on the vector built with the data of the first three channels (RIGHT input).
- **PROFILE**: *graphical form* profile of a chosen parameter, related to the acceleration on each channel calculated at programmable intervals from 1s to one hour. The last 100 values of the chosen parameter are visualized.
- **SPECTRUM**: graph of the octave or third-octave bands spectrum graphic, related to the acceleration on each channel. A wide band parameter, calculated from the measured spectra, is associated with the spectrum. In addition to the accelerations, it is possible to visualize the speeds or the displacements, making a single or double integration on the spectrum. The spectrum can be visualized in *multi-spectrum mode* (MLT: one spectrum per second) or in *averaged spectrum* (AVR) where the spectrum is linearly integrated in all the measurement time.
- **PROBABILITY**: graph of the *probability distribution* of the parameter visualized in the PROFILE screen for each channel. The values are analyzed in classes of 1dB.
- **PERCENTILES**: graph of *percentile levels* related to the parameter visualized in the PROFILE screen for each channel.

The transition from one screen to the next one can be made at any time by pressing the **MODE** key. At start-up, after the selection of the inputs configuration, the instrument displays the VLM screen.

Some indications appear in all the modes, they are:

- The indicator of the acquisition status,
- The overload indicator,
- The indicator of the remaining batteries charge.

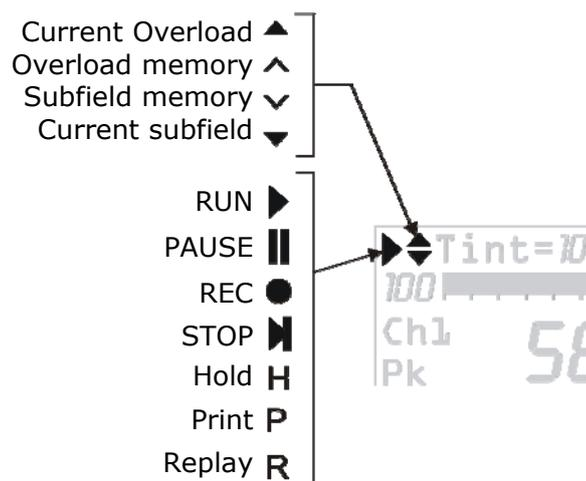

The first symbol in the top left corner of the display indicates the **acquisition status** of the vibration analyzer.

**RUN**: the instrument is acquiring.

**PAUSE**: the calculation of the integrated measures and the eventual measures recording are paused. The instant parameters continue to be measured and visualized.

**REC**: The instrument is acquiring and recording.

**STOP:** the instrument does not perform any measurement.

**H (HOLD):** the calculation of the integrated measurements has come to the end of the integration interval or the HOLD key was pressed.

**P (Print):** the printing of the current data is running.

**R (Replay):** it appears (blinking) when the "MEMORY NAVIGATOR" program is used to display a file saved in the instrument memory.

Immediately to the right of the symbol indicating the acquisition mode, there is the symbol indicating the possible **overload**. An **arrow pointing up** indicates that the input level has exceeded the maximum level measurable, a **down arrow** indicates that the input level is below the minimum according to the selected gain.

The maximum measurable level in the different settings of the measurement range selector is indicated in the technical specifications (see the chapter "TECHNICAL SPECIFICATIONS").

An internally empty arrow reminds that an overload occurred, while a full arrow indicates that the signal is currently exceeding the limit.

To the right of the overload indicator it is displayed the **integration time Tint** of the instrument, which is programmable from 1s to 99h. When the integration mode is set to *multiple*, the "Tint" symbol in the VLM screen blinks. If Tint = 0, the integration becomes continue.

In the upper right corner there is the **battery symbol**. The batteries discharge appears as a gradual emptying of the symbol. When the remaining working time of the instrument is about 10%, which is roughly correspondent to 30 minutes in the continuous acquisition, the battery symbol blinks. A protective device prevents the instrument from taking measurements with insufficient charge level and automatically shuts the instrument off when the charge level is reduced to a minimum.

The charge level of the batteries, expressed in percentage, is visible in the menu main screen, that can be accessed pressing the MENU key once. Press the MENU key again to return to the measurement screen.

For details, see the chapter "REPORTING OF LOW BATTERIES AND REPLACEMENT OF BATTERIES."

Pressing the **ENTER** key, the parameters related to the visualized screen can be selected in sequence. While the selected parameter is blinking, it is possible to change it pressing the UP and DOWN arrow keys. Pressing ENTER, or automatically after about 10s, the parameter is confirmed and the selection mode is exited.

In graphic visualization mode it is possible to change the parameters of the vertical scale using the UP, DOWN, LEFT and RIGHT arrow keys: the LEFT and RIGHT keys compress and expand the vertical scale respectively, the UP and DOWN keys decrease and increase the initial and final levels of the vertical scale; in this way the graphic is moved upwards and downwards respectively.

## VLM SCREEN

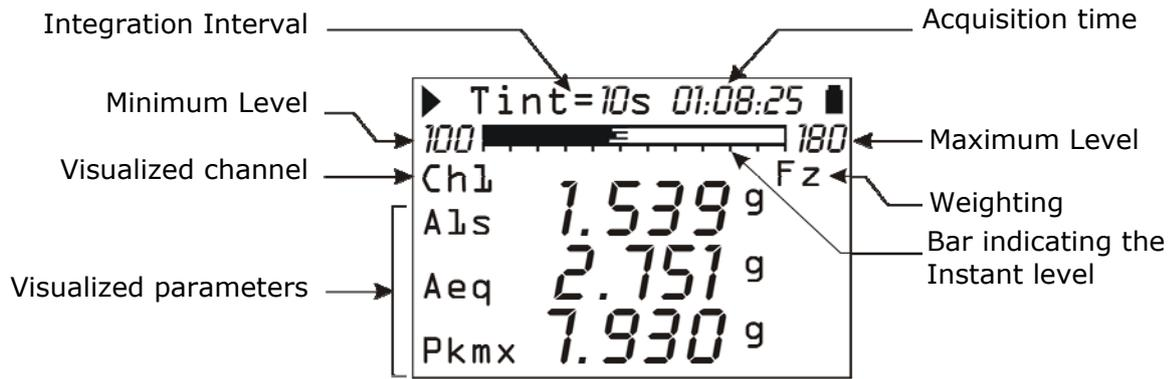

The VLM screens shows, in numerical form, three frequency weighted parameters related to each of the four measurement channels or to the acceleration vector calculated with the data of the first three channels. **It is possible to scroll in sequence the screens using the right and left cursor keys.**

The horizontal bar visualizes the instant levels of the four measurement channels expressed in dB.

### VLM\_1 and VLM\_2

The first two screens **VLM\_1** and **VLM\_2** present **instant and integrated parameters** that are acquired, and in case memorized, as a profile form with 1 second acquisition interval or integrated with intervals programmable from 10s to 1 hour. In the **VLM\_2** screen are visualized the parameters related to the channels of the vector acceleration sum (CHΣ) and maximum (CHM). **The measurement parameters to be displayed can be set entering the menu Parameters >> Vibration Analyzer.**

### VLM\_3 and VLM\_4

The last two screens **VLM\_3** e **VLM\_4** present **global parameters integrated in all the measurement period**. It is possible to automatically memorize the value of these parameters at the end of each measurement session. In the **VLM\_4** screen are visualized the parameters related to the channels of the vector acceleration sum (CHΣ) and maximum (CHM). **These measurement parameters can be set entering the menu Parameters >> Data Logger >> Global.**

**To change the measurement unit without entering the instrument menu, it is sufficient to use the RIGHT and LEFT arrow keys.** The measurement units are dB, m/s<sup>2</sup>, cm/s<sup>2</sup>, ft/s<sup>2</sup>, in/s<sup>2</sup>, g. The measurement unit selected is unique and it is applied to all the visualized parameters.

**The CHN key allows to change the visualized channel.** The measurement channels of single axis acceleration are four (CH1,..., CH4) while the measurement channels of the vector acceleration are two: the "sum" vector (CHΣ) and the "maximum" vector (GHM), both calculated with the data of the first three measurement channels (RIGHT input).

The "sum" vector is defined by the relation:

$$a_v^{SOMMA} = \sqrt{(C1 * a_{P1}^{ch1})^2 + (C2 * a_{P2}^{ch2})^2 + (C3 * a_{P3}^{ch3})^2}$$

While the "maximum" vector is defined by the relation:

$$a_v^{MASSIMO} = \sqrt{\max[(C1 * a_{P1}^{ch1})^2, (C2 * a_{P2}^{ch2})^2, (C3 * a_{P3}^{ch3})^2]}$$

Where:

- C1, C2 and C3 are the multiplying coefficients for each channel that can be set through the menu Parameters>> Instrument >> Measurement>> Coeff.1, Coeff.2 and Coeff.3
- $a_{P1}^{ch1}$ ,  $a_{P2}^{ch2}$ ,  $a_{P3}^{ch3}$  are pondered acceleration found on each of the three channels. The frequency weightings are set in the menu Parameters>> Instrument >> Measurement>> Pond.1, Pond.2 and Pond.3.

From the menu (MENU>> Parameters>> Instrument >> Measure>> Ch1-4), **it is possible to disable one or more measurement channels**, for example because they are not in use. The status of each channel is indicated in the menu with a number: 0 (zero) indicates a disabled channel, 1 indicates an active channel.

The four channels are indicated in the order CH1, CH2, CH3, CH4: in order to have all the channels activated, the menu item must be **Ch1-4=1111**. To disable the CH1 channel, for example, the menu item must be Ch1-4=0111. **It is not possible to disable all the channels at the same time.**

**When one or more of the channels CH1, CH2 or CH3 are disabled, the measurements related to the "sum" and "maximum" vector are not visualized on the display.**

The visualized measurement parameters can be changed without entering the menu of the instrument. **Pressing the ENTER key while the instrument is in STOP mode, the directly editable parameters can be scrolled in sequence.** When the selected parameter blinks, it is possible to modify it using the UP and DOWN arrows.

The changeable parameters are:

- **Integration time** (Menu >> Parameters >> Instrument >> Measurement >> Integration Interval).  
Settable from 1s to 99 hours (when it is set to 0 the integration is continuous). Pressing the RIGHT arrow while the value is blinking, the **multiple integration mode** is selected (Menu >> Parameters >> Instrument >> Measure >> Integration Mode). To set the **single integration mode**, it is sufficient to press the LEFT arrow. When the integration mode is multiple, the symbol "Tint" blinks to indicate that the instrument will execute many integration intervals in sequence, each of them with a duration equal to the integration time set.
- **The three measurement parameters of acceleration** (Menu >> Parameters >> Vibration Analyzer) for the three parameters related to each channel, to sum vector and maximum value associated with VLM\_1 and VLM\_2 screens. For VLM\_3 and VLM\_4 screens, the acceleration measurement parameters changeable directly, are the ones in Menu >> Parameters >> Data Logger >> Global.

When one of the acceleration measurement parameters is selected, the parameter symbol blinks. Pressing the UP and DOWN arrows it is possible to scroll in sequence all the measurement parameters available.

- The **frequency weighting** applied to each measurement channel (Menu >> Parameters >> Instrument >> Measure >> Pond. Ch-x with x=1,..,4). While the frequency weighting symbol blinks, it is possible to modify the weight using the UP and DOWN arrows. The weighting can be changed only in VLM\_1 and VLM\_3 screens. The VLM\_2 and VLM\_4 screens report the abbreviation of the weightings applied to the three channels CH1, CH2 and CH3: e.g. "zch" means CH1=Fz, CH2=Fc and CH3=Wh.

## PROFILE SCREEN

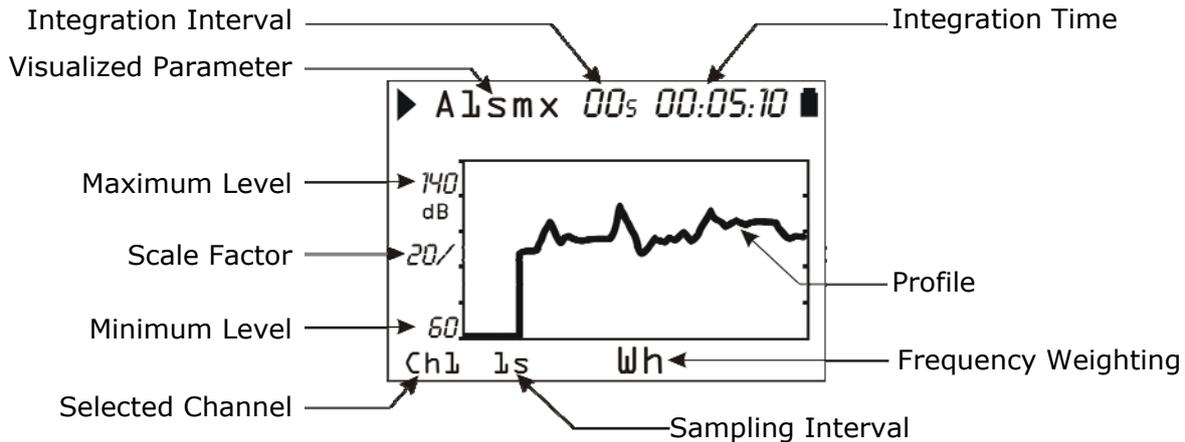

This screen presents in graphic form the profile of a frequency weighted parameter related to each of the 4 measurement channels.

The values can be visualized in dB or in  $m/s^2$  (Menu >> Parameters >> Instrument >> Measure >> Measurement Unit).

**The CHN key allows to change the visualized channel.**

**With the LEFT and RIGHT arrow keys it is possible to change the vertical scale of the graph while with the UP and DOWN arrow keys it is possible to choose the reference value of the vertical scale.**

It is possible to activate two **cursor**s to read the value in two points at choice of the graph. Pressing the CURSOR key once, the first cursor is activated, pressing the second time, the second cursor is activated while pressing the CURSOR key the third time, both cursors are activated in tracking mode. To place the cursors in the desired points, the arrow keys next to the CURSOR key can be used.

Using the **HOLD** key, the graph updating is paused, allowing a comfortable reading of the measured values. Press again the HOLD key to return to real time visualization.

The sampling time of the graph can be selected from 1s up to 1 hour per point.

The parameter selected for this screen is the same used for the statistical analysis (see PROBABILITY and PERCENTILES screens) with a 1s sampling interval.

The visualized measurement parameters can be modified without entering the menu of the instrument. **Pressing the ENTER key while the instrument is in STOP mode, the directly changeable parameters can be scrolled in sequence. When the selected parameter blinks, it is possible to modify it using the UP and DOWN arrows.**

The editable parameters are:

- The **acceleration measurement parameter** (Menu >> Parameters >> Vibration Analyzer >> Profile). Pressing the UP and DOWN arrows, it is possible to scroll in sequence all the measurement parameters available.
- The **sampling interval** of the measurement parameter (Menu >> Parameters >> Instrument >> Measurement >> Sampling Profile). It can be set from 1s up to 1 hour.
- The **integration interval** (Menu >> Parameters >> Instrument >> Measurement >> Integration Interval). It can be set from 1s to 99 hours (when it is set to 0, the integration is continuous).
- The **frequency weighting** (Menu >> Parameters >> Instrument >> Measurement >> Wh. Ch-x with  $x=1,..,4$ ). The parameter is associated with the measure channel visualized. To modify it, use the UP and DOWN arrows.

## SPECTRUM SCREEN

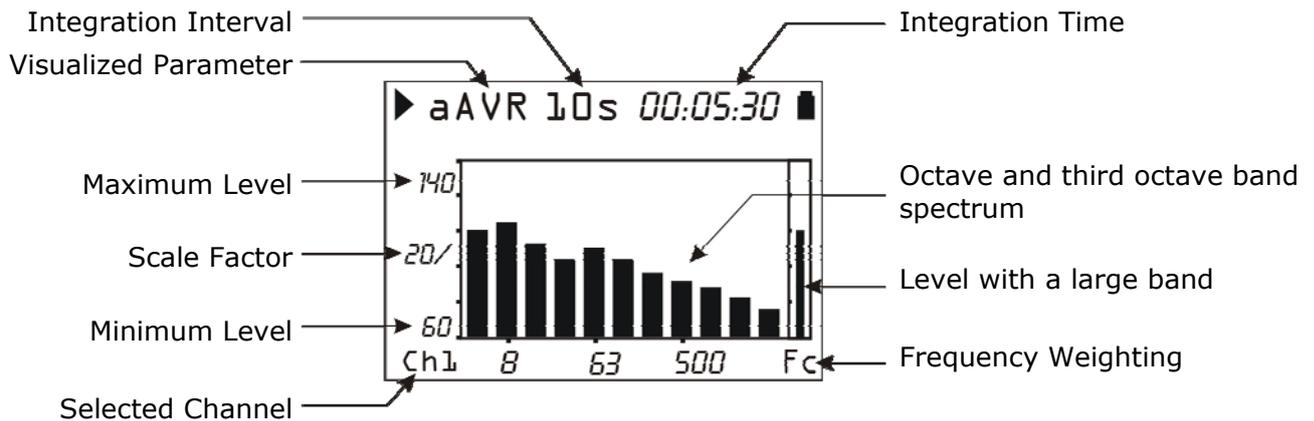

The SPECTRUM screen presents in graphic form the octave or third-octave bands spectrum related to each of the 4 measurement channels. The order of the visualized spectrum, in octave or third-octave bands, is set entering the Menu >> Parameters >> Spectrum Analyzer >> Order.

The values can be visualized in dB or in  $m/s^2$ .

**The CHN key allows to change the visualized channel.**

**With the LEFT and RIGHT arrow keys it is possible to change the vertical scale of the graph while with the UP and DOWN arrow keys it is possible to choose the reference value of the vertical scale.**

The spectral analysis is made both in **multi-spectrum mode (MLT)**, where a spectrum every second is visualized, and in **average spectrum mode (AVR)**, where the spectrum integrated in all the measurement time is visualized.

It's possible to associate with the octave or third-octave bands spectrum, the value of the frequency weighted acceleration, calculated from the spectrum.

## CURSORS OPERATION

It is possible to activate **two cursors** to read the value of the visualized bands. Pressing the **CURSOR** key once, the first cursor is activated, pressing the second time, the second cursor is activated while pressing the CURSOR key the third time, both cursors are activated in tracking mode. To place the cursors in the desired points, the arrow keys next to the CURSOR key can be used.

When the cursors function is not active, it is possible to pass from the visualization of the acceleration for each band to the **speed** or **displacement** visualization, pressing in sequence the left and right cursor keys.

Using the **HOLD** key, the graph updating is paused, simplifying the reading of the measured values. Press again the HOLD key to return to the real time visualization.

**Keeping pressed the cursors activation key, the limit acceleration curve is visualized.** This curve is based on the acceleration value in the band selected with the cursor L1 and presents for each band the limit value of the acceleration corresponding to a displacement equal to that of the selected band.

For example, it is possible to choose as reference band with the cursor L1 the band corresponding to the dominant frequency of the spectrum and, supposing that the displacement component at this frequency is also dominant, visualize the maximum acceleration levels on the other bands of the spectrum that cause displacement values equal to or lower than the one of the selected band. Eventual phenomena of DC-shift happen with acceleration values at low frequencies with unreal associated displacements and so can be easily localized because they

will be associated with values of acceleration at low frequencies greater than the visualized limit.

**To disable the limit acceleration curve keep pressed the CURSOR key.**

**The visualized measurement parameters can be modified without entering the menu of the instrument.** Pressing the ENTER key while the instrument is in STOP mode, the directly changeable parameters can be scrolled in sequence. When the selected parameter blinks, it is possible to modify it using the UP and DOWN arrows.

The changeable parameters are:

- The **integration interval** (Menu >> Parameters >> Instrument >> Measure >> Integration Interval). It can be set from 1s to 99 hours (when it is set to 0, the integration is continuous)
- The **frequency weighting** of the acceleration value associated with the spectrum (Menu >> Parameters >> Spectrum Analyzer >> Auxiliary weight). This parameter is changeable also in measuring mode.
- **The type of the visualized spectrum MLT or AVR** (Menu >> Parameters >> Spectrum Analyzer >> Mode). This parameter is changeable also in measuring mode.

## DISTRIBUTION OF PROBABILITY SCREEN

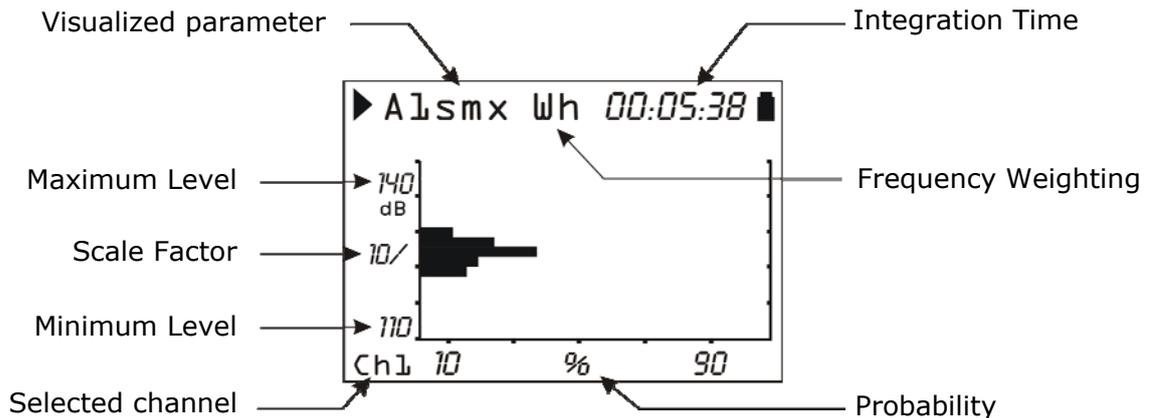

The PROBABILITY screen presents in graphic form the probability distribution of the values of the parameter visualized in the PROFILE screen for each of the 4 channels.

The values can be visualized in dB or in  $m/s^2$ .

**The CHN key allows to change the visualized channel.**

**With the LEFT and RIGHT arrow keys it is possible to change the vertical scale of the graph while with the UP and DOWN arrow keys it is possible to choose the reference value of the vertical scale.**

### CURSORS WORKING

It is possible to activate **two cursors** to read the probability in two points at choice in the graph or, when they are both selected, to calculate the probability to have a value between the two cursors. Pressing the CURSOR key once, the first cursor is activated, pressing the second time, the second cursor is activated while pressing the CURSOR key the third time, both cursors are activated in tracking mode. To place the cursors in the desired points, the arrow keys next to the CURSOR key can be used.

The statistical analysis is done in 1dB classes, sampling the value of the parameter selected for the PROFILE screen once per second for each of the 4 channels.

**The visualized measurement parameters can be modified without entering the menu of the instrument.** Pressing the ENTER key while the instrument is in STOP mode, the changeable parameters can be scrolled in sequence. When the selected parameter blinks, it is possible to modify it using the UP and DOWN arrows.

The editable parameters are:

- The **acceleration measurement parameter** (Menu >> Parameters >> Vibration Analyzer >> Profile).
- The **frequency weighting** (Menu >> Parameters >> Instrument >> Measurement >> Wh. Ch-x with  $x=1,..,4$ ). The parameter is associated with the visualized measurement channel. To modify it, use the UP and DOWN arrows.

## PERCENTILES SCREEN

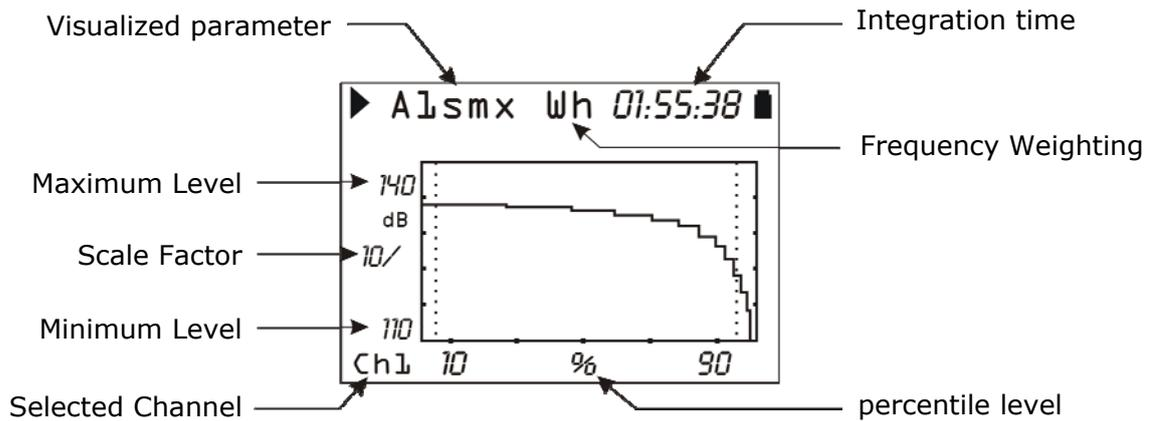

Percentile screen presents in graphic form the percentile levels from  $L_1$  to  $L_{99}$  associated with the parameter visualized in the PROFILE screen for each of the 4 channels.

The values can be visualized in dB or  $m/s^2$ .

**CHN** key allows to change the visualized channel.

With **LEFT** and **RIGHT** arrow keys you can change the vertical scale of the graphic while with **UP** and **DOWN** arrow keys you can chose the value in reference with the vertical scale.

### CURSORS FUNCTIONS

It is possible to activate a cursor to examine the graph. Pressing the **CURSOR** key, the cursor is activated; in order to place the cursor in the desired point, the arrow keys next to the **CURSOR** key can be used.

To facilitate the graph viewing, two dashed vertical bars are displayed in correspondance of 5 and 95%.

**The visualized measurement parameters can be modified without entering the menu of the instrument.** Pressing the **ENTER** key while the instrument is in **STOP** mode, the changeable parameters can be scrolled in sequence. When the selected parameter blinks, it is possible to modify it using the **UP** and **DOWN** arrows.

Can be modified:

- The **acceleration measurement parameter** (Menu >> Parameters >> Vibration Analyzer >> Profile).
- The **frequency weighting** (Menu >> Parameters >> Instrument >> Measurement >> Wh. Ch-x with  $x=1,..,4$ ). The parameter is associated with the visualized measurement channel. To modify it, use the **UP** and **DOWN** arrows.

## APPLICATIONS

The HD2030 analyzer can measure vibrations in three different applications selectable with the parameter Menu >> Parameters >> Instrument >> Measurement >> Application:

- **Hand Arm (HA)** for the measurements of vibrations transmitted to the hand-arm system, for example by tools through the grip.
- **Whole Body (WB)** for the measurements of vibrations transmitted to the whole body, for example to a driver through the seat.
- **Building Vibration (BV)** for the measurement of vibrations transmitted to the whole body by buildings.

In general, different applications require specific accelerometers which differ mainly for the sensitivity, frequency response, weight and mounting characteristics.

The accelerometers suitable for the HD2030 may be triaxial or mono-axial type with integrated electronics (IEPE or equivalent) and sensitivity from 1 mV/g to 1V/g.

These accelerometers are current-supplied by the analyzer with a bias voltage of 25V and a maximum current equal to 2mA.

Since the dynamic range of the accelerometer- analyzer chain is limited to about 100dB, in order to perform all types of vibration measurements (hand-arm and whole body vibration or buildings), accelerometers with different sensitivities are required. In fact, while for the measurement of vibration transmitted to the hand-arm can be used an accelerometer with a sensitivity from 1 mV/g to 10 mV/g, capable of measuring peak accelerations up to  $5000 \div 50000 \text{ m/s}^2$ , for the measurement of accelerations in buildings it is necessary to use accelerometers with a sensitivity of 1 V/g, in order to measure accelerations starting from  $1 \text{ mm/s}^2$ .

### HAND ARM

Many tools operated or gripped by hands generate vibrations. In some of these tools the vibration levels can be very high: for example, saws, hammers, grinders, drills, cleaners, vibrating plates, mowers, hammers, etc.. The vibration is transmitted to the operator's hands (and arms) through physical contact with the utensil. In some cases vibration is transmitted directly by gripping the part to be machined (such as on a column grinder).

The procedures for measuring and assessing exposure of workers to hand-arm vibration are defined by ISO 5349-1 and ISO 5349-2. For measurements are used accelerometers with a sensitivity from 1 mV/g to 10 mV/g, reduced size and weight, capable to measure weighted accelerations of about  $1 \text{ m/s}^2$  while, at the same time, very high peak accelerations even higher than  $10000 \text{ m/s}^2$ . In most practical situations will be used a miniature triaxial accelerometer, with a sensitivity of 10mV/g and resonant frequency greater than 10kHz. When the peak accelerations exceed 1000g repeatedly, it is necessary to use a *shock accelerometer* with 1mV/g sensitivity and resonant frequency greater than 50kHz. In this case also a mono-axial accelerometer is enough, taking care to orientate it so as to measure the accelerations along the dominant axis. For exposure assessment should be considered vibrations being transmitted to

the center of the operator's hand during the tool's grip and use. Since normally it is not possible to fix the accelerometer in that position, while this would constitute an obstacle to the operator, the accelerometer is fixed at the closest position to the one occupied by the hand (so that it would not constitute a disturbance to the use of the machine itself). The picture shows the position in which, according to ISO 5349-2, the accelerometer is attached to the handle of hammers and chipping hammers. In some cases, for the particular shape of the handles or the overall dimensions of the control lever, it is not possible to fix the accelerometer in accordance with the standard's guidance.

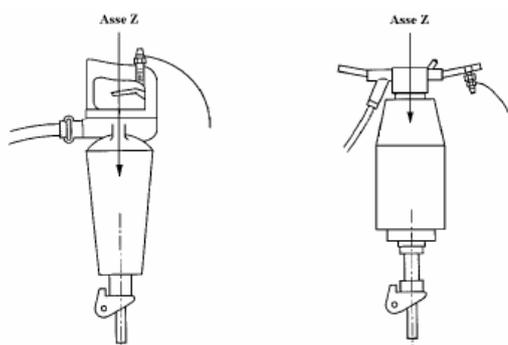

In this case an alternate location in the closest possible location to the operator's hand will be found. The demolition hammers have two handles, one of which cannot be used to fix

the accelerometer because it's entire length it occupied by the operating lever: the transducer must be necessarily mounted on the handle without the lever.



These pictures show the possibility to mount the sensor for two different handles categories. The ISO standard 5349-1 specifies the orientation of the reference system according to which are to be collected the three acceleration's vector components;



nevertheless, for each specific category of portable machine tool, ISO 8662 gives the definition of the specific coordinates to be adopted.

The standard defines the coordinate system:

- **Z direction:** the direction parallel to percussion direction; in ISO 5349-1 this axis takes the direction of the third metacarpal bone of the operator's hand;
- **Y-direction:** the direction in the plane including the handle and the Z axis; orthogonal with the Z axis.
- **X -direction:** direction perpendicular to Y and Z directions.

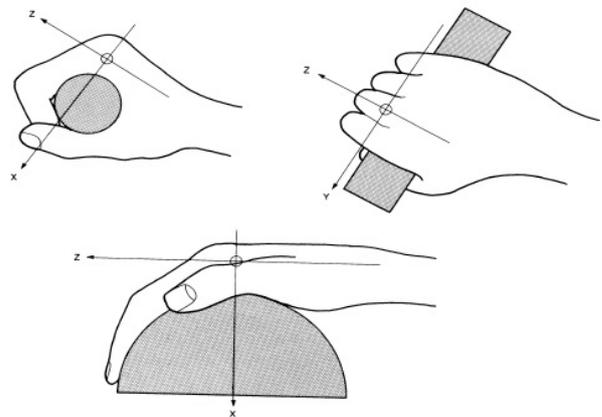

Since the ISO 5349-1 introduced as evaluation parameter the accelerations vector sum, the orientation of the coordinate system, purely conventional, does not affect the evaluation procedure; it is therefore independent of the reference system adopted.

Selecting the application Menu >> Parameters >> Instrument >> Measurement >> Application: HA, the HD2030 analyzer performs measurements in accordance with ISO 5349. The weighted acceleration (to simulate the the hand-arm system sensitivity), is calculated applying the filter named Wh on all measurement axes. Alternatively are available the band-pass filters Fz and Fc, respectively, 1 Hz ÷ 3.5 kHz and 6.3 Hz ÷ 1250 Hz and the analyzer measures the accelerometer's signals spectrum by octave bands from 4Hz to 2 kHz or third octave from 3.15 Hz to 3.15 kHz.

In the vibrations transmitted to hand-arm system, transducer's mounting is the most delicate operation. The accelerometer weight should be less than 10% the weight of the tool and typically less than 30g including the weight of the mounting adapter. The accelerometer must be fixed to the handle so as to follow the oscillations, therefore allowing acquisition of vibrations effectively transmitted to the operator's hand.

### HD2030AC1



The HD2030AC1 is a compact cube adaptor that is fixed with a plastic or metal strip to the handle of the tool to analyze. The position must be chosen as close as possible to that occupied by the hand according to the indications of ISO 5349-2. Light alloy built, it is suitable for measurements on lightweight tools where it is necessary to contain the weight of the measuring system. It can be used with accelerometers with a threaded hole (10-32 UNF or UNC 5-40); the accelerometer is secured by a screw on the adapter. This support ensures easy and quick mounting and optimum adaptation to different types of handles. The accelerometer, equipped with a threaded hole (10-32 UNF 5-40 or UNC), is secured to the adapter via a tightening screw which, passing through a hole on the

upper surface of the adapter, is screwed to the accelerometer base. The vibrations produced by percussive machine tools movement, are characterized by very high frequency and intensity acceleration's spectral components. With this loads, the piezoelectric crystal, which implements acceleration's transduction into electrical signal, is subjected to stress and generates a continuous spurious signal very high for a long time, even after the physical load has ended; the spurious signal overlaps the detected signal adding distortion to the measurement.



To avoid this phenomenon, called "**DC shift**", it is necessary to reduce the accelerometer's loads at higher frequencies. Normally, the presence of dumping material on the handle or the interposition of a thin rubber layer (1-2 mm) between the support of the accelerometer and the handle, are sufficient to prevent the phenomenon (1 in the picture). The resilient material must be compressed to the maximum tightening of the clamp mounting of the support. To avoid damaging the resilient material while tightening, it is sufficient to interpose a alloy ring with a thickness of 1-2 mm between such material and the clamp (2 in the picture). The vibrations transmitted from the tool to the hand-arm will be properly represented only under certain conditions by the measurement made by fixing the accelerometer to the handle as previously described. In fact, by the tightening of the adapter to the handle depends the fraction of vibrational energy transmitted to the sensor and therefore measured. It's evident that tightening the clamp to the maximum will be obtained a high mechanical coupling and therefore the measured acceleration will be maximum. However, not always by tightening the clamp to the maximum, it will be achieved a representative measure of the

true stress the operator's hand is subjected to. Normally the operator tightening the handle exerts a variable grip strength, depending on the particular processing step and in any case a compromise between operational effectiveness and comfort. To detect the vibrations really transmitted by the tool to the operator it is sometimes convenient to use supports with specific shapes to be interposed between the hand and the handle.

#### HD2030AC2



HD2030AC2 and HD2030AC3 adapters must be gripped between the hand and the handle. As the accelerometer is fixed in a lateral position, the measurement must be repeated by placing the accelerometer on both sides of the hand.

These adapters are suitable for large cylindrical handles coated with resilient material.

#### HD2030AC3



The HD2030AC2 is made of light alloy and fitted with accelerometers using a threaded hole (10-32 UNF or UNC 5-40); accelerometer is secured by a screw on the adapter.

The HD2030AC3 is steel made and has to be used with accelerometers having integrated screw (10-32 UNF); accelerometer is fixed to the

adapter using the threaded hole.

#### HD2030AC4



The HD2030AC4 is an adapter to be held between the hand and the handle. The accelerometer is placed in central position between the middle finger and the ring finger or between the index and the middle fingers. Light alloy made, it is suitable for anatomical shape, non-cylindrical and/or small dimension handles.

It must be uses with accelerometers fitted with a threaded hole (10-32 UNF or UNC 5-40); accelerometer is secured by a screw on the adapter.

The spectral analysis is performed in the range 3.15Hz to 3150Hz. In the measurements of the vibrations transmitted to the hand-arm system, it is useful the visualization of the limit acceleration available in the SPEC-

TRUM screen.

In case of doubt, it is possible to enable the direct recording of the signal provided by the accelerometers (only with storage in memory card). The DC-shift phenomena can be easily detected analyzing the signal of the accelerometers with the Noise Studio software supplied.

## WHOLE BODY

The reference standard for assessing exposure to whole-body vibration is there-ISO 2631-1:1997. It defines standardized methods for measuring whole-body vibration and provides some guidelines for the assessment of health effects. The Vibration's transmission can be through the feet of a person standing or sitting on a seat, through the buttocks and the back if the person is sitting, or through the support area for a person in a supine position.

The standard defines the coordinate systems for the measurement of acceleration; x, y and z axes are always directed in the same direction but with different origins, depending on the position of the operator is sitting, standing or lying down. In whole body vibrations the z axis, which is directed in the spinal column direction, is the higher risk organ to vibrations exposure.

The recorded magnitude is the r.m.s. weighted acceleration value (Root mean square value) in the frequency range from 0.5 Hz to 80 Hz. Below 0.5Hz the body, as a single mass, homogeneously follows the displacement of the vibrating surface with which it is in contact to. Higher frequencies than 80Hz involve only the surface of the body where the contact is; deeper layers of the epidermis leads to a rapid attenuation of vibrations not reaching internal structures of human body.

Procedures to measure and assess worker's exposure to whole-body vibrations are defined in

ISO 2631-1 and ISO 2631-2. For whole body vibration measurement is used an accelerometer with a typical sensitivity of 100mV/g. The accelerometer may be fixed directly to the surface transmitting vibrations to the human body using a screw or using glue. Alternatively, if the surface is metallic, it is possible to fix the accelerometer using a magnetic support. The magnetic base can also be used for non-magnetic surfaces; a metal disk can be glued to the surface, then the accelerometer (mounted on the magnetic base) fixed on it.

If the surface is not sufficiently planar, it is possible to use a mobile support where the accelerometer is fixed; the weight of the support must be sufficient to ensure acceleration

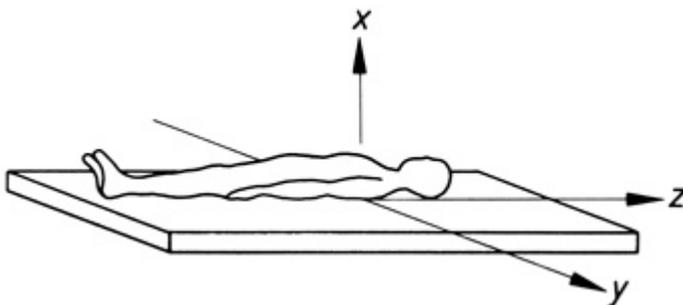
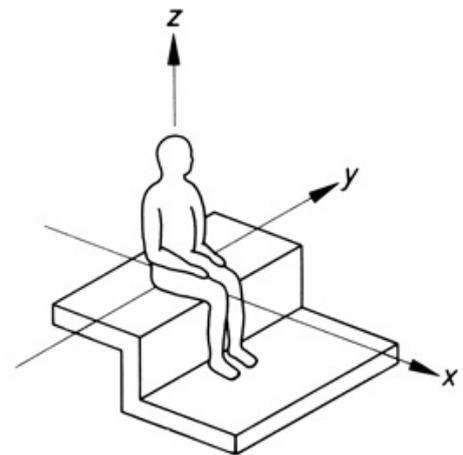
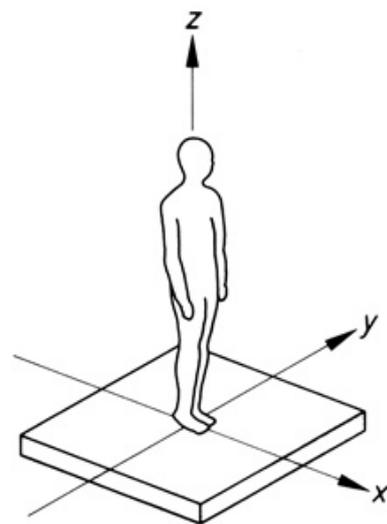

measurement up to at least  $1\text{m/s}^2$ .

## HD2030AC5



Support suitable for vibration measurements on floors and other surfaces.

Provides three different fixing points:

- in the hollow seat placed on the support's lower face
- on the upper face with a threaded hole,
- on the adaptor cube fixed on upper face.

To access the hollow seat, unscrew the three screws used to close the back. The cavity has been sized for hosting a triaxial accelerometer with a central hole.

The accelerometer's connecting cable passes through the side hole (see picture). To help analysis of acquired signals, we recommend that you

reproduce, on the upper face, the same axial directions of the sensor.

On the upper face is present a threaded hole for mounting a triaxial or monoaxial accelerometer.

Usually the accelerometer's sensitivity should be about 100 mV/g for working environment measurement and 1V/g for building vibrations annoyance measurements.

With the support is provided a cube adapter to be fixed on the upper face; this is for connection of three high sensitivity mono-axial accelerometers. To connect the three accelerometers to HD2030 analyzer is requested HD2030.CAB13 cable.

The support is provided with three support feet and a spirit level: if necessary, adjust the two mobile feet to adapt the horizontal position of the support using the spirit level as a reference.

To measure vibrations transmitted from seats and backs, the accelerometer is normally inserted in a rubber pad, made according to the requirements of EN 30326-1. This pad is positioned on the seat or fixed on the backrest with a tape so that is interposed between the seat itself and the body part submitted to vibrations.

Unlike the measurement of hand-arm vibrations, where the modulus of the acceleration vector is compared to the legal limits, to the extent of whole-body vibration it is the comparison with the dominant component, namely the one along the axis having the greatest strain. It's therefore necessary to accurately orient the accelerometer's axes according to the reference system established by ISO 2631-1 in order to avoid recalculating x, y and z acceleration components. Selecting the Menu >> Parameters >> Instrument >> Measurements >> Application: WB, the HD2030 analyzer performs measurements in accordance with ISO 2631-1.

The acceleration (frequency weighted to simulate the human body sensitivity to vibration) is calculated by applying the filters Wb, Wc, Wd, We, Wj, Wk to the measurement axes, as a function of the body's part subjected to vibrations and the type of assessment needed: person's health, comfort or perception. Alternatively are available Fz and Fa band-pass filters respectively 0.2 Hz ... 3.5 kHz and 0.4 Hz ... 100 Hz

The analyzer can calculate the accelerations spectra in octave bands from 1 Hz to 250 Hz or in third octave from 0.5 Hz to 315 Hz

## BUILDING VIBRATION

With this application, the HD2030 analyzer performs the measures in accordance with ISO 2631-2. For the evaluation of annoyance due to vibrations transmitted by the building structure, accelerometers are used with high sensitivity (typically from 1V/g) and resonance frequency greater than 1000Hz. The accelerometer is typically mounted on a heavy block to be placed on the floor, like HD2030AC5 (see description in the previous paragraph).

Selecting the Menu >> Parameters >> Instrument >> Measurements >> Application: **BV**, the HD2030 analyzer performs the measurements according to ISO 2631-2.

The acceleration signal, weighted to simulate the human body sensitivity to vibration, is filtered with Wm weighting on all measurement axes. Alternatively Fz and Fm band-pass filters are available respectively 0.2 Hz ... 3.5 kHz and 0.8 Hz ... 100 Hz

The analyzer can calculate the accelerometer signal spectrum in octave bands from 1 Hz to 250 Hz or third octave from 0.5 Hz to 315 Hz

## MEASUREMENT MODES

The HD2030 analyzer is able to measure in two different modes, selectable with the parameter Menu >> Parameters>> Instrument >> Measurement >> Integration Mode:

- **Single Integration (SING)** with measurement time programmable from 1s to 99 hours, and the possibility of manual stop.
- **Multiple Integration (MULT)** with manual stop of the measurement. The measurement time is divided in time intervals programmable from 10s to 1 hour.

**The measurement starts pressing the START/STOP key.**

At the beginning, the measurements are affected by the settling time of the accelerometers signals. To minimize the effect, after starting the measurement pressing the START/STOP key, the instrument keeps zeroed the instant and integrated parameters until it is elapsed the delay time, that can be set with the parameter "Menu>> Parameters>> Instrument >> Measurement >> Integration Delay", from a minimum of 1 second to a maximum of 99 seconds.

### SINGLE INTEGRATION

**In this mode, the instrument calculates the integrated parameters, like the average time of acceleration for example, in the set measurement time Tint.**

The measurement time is programmable from a minimum of 1 second to a maximum of 99 hours with the Menu>> Parameters>> Instrument >> Measurement >> Int. Integration.

It is possible to pause the measurement by pressing the PAUSE key, and restart the measurement by pressing the same key. While the instrument is paused it is possible to reset all the integrated parameters by pressing the START/STOP key.

**The measurement ends automatically when the set integration time expires, or manually by pressing the START/STOP key.**

At the end of the measurement, the integrated parameters indicate the value calculated in all the measuring period, excluding the pause intervals.

The spectral analysis, if performed in AVERAGE mode (Menu>> Parameters>> spectrum analyzer>> Mode: AVERAGE), and the statistical analysis provide respectively the average spectrum, the probabilities and percentiles levels calculated in the measurement time.

### MULTIPLE INTEGRATION

**In this mode the instrument calculates the integrated parameters, like the average acceleration for example, at regular time intervals with a set duration.**

The duration Tint of each interval is set through the Menu>> Parameters>> Instrument >> Measurement>> Int. Integration, from a minimum of 10 seconds to a maximum of 1 hour.

**The measure ends pressing the START/STOP key.**

It is possible to pause the measurement pressing the PAUSE key, to start again the measurement press the same key.

While the instrument is paused, it is possible to reset all the integrated parameters by pressing the START/STOP key.

At the end of *each interval*, the integrated parameters, the statistical analysis and the spectrum, when done in AVERAGE mode (Menu>> Parameters >> Spectrum analyzer>> Mode: AVERAGE), are automatically reset.

This mode of integration can be used for purposes of monitoring, for example when it is necessary to detect the average value of acceleration every minute.

## USE OF THE EXTERNAL MEMORY CARD

The HD2030 has an interface that handles an external memory card for storing the data, the configuration parameters of the instrument and sensors.

The memory card, supplied with the instrument, has Delta Ohm code HD2030MC. If cards not supplied by Delta Ohm are used, make sure they have the same read / write speed performances.

The card must be **SD**-type with a maximum capacity of **2GB**.

To use a *new* memory card, it is necessary:

1. to format it using the Noise Studio PC software.
2. to initialize it using the HD2030: the initialization function creates the folder where the measurement files will be placed and copy the calibration log file (see the description of the calibration program).

The formatting operation requires a PC equipped with a memory card reader (not supplied with the instrument). Normally all the latest laptop and desktop PC are provided with it. If not, it is possible to use an external memory card reader connectable to a USB port.

### To format a SD card, proceed as follows:

- If the PC is without reader, connect an external SD cards reader to a PC USB port.
- Start the Noise Studio software.
- Press the instrument management key in Noise Studio: press the Format Memory Card key.
- Select the path of the card to be formatted and press ENTER.
- In the next screen make sure it is selected the parameter "File System = FAT" and press START: the card is formatted.
- When it appears the message "Formatting completed", press OK to confirm and CLOSE to exit.
- Close the Noise Studio software.
- The formatting procedure is complete.

### To initialize a card, proceed as follows:

Two methods are provided:

- Use of the "Initialization MC" function in the programs menu of the instrument (see the details in the description of the programs): this feature erases the eventual data already existing in the card.
- If the card is new and already formatted, turn on the instrument after inserting the card into the front slot of the instrument: the initialization procedure starts automatically. At the end of the operation, it appears the message "MC installed and ready to use."

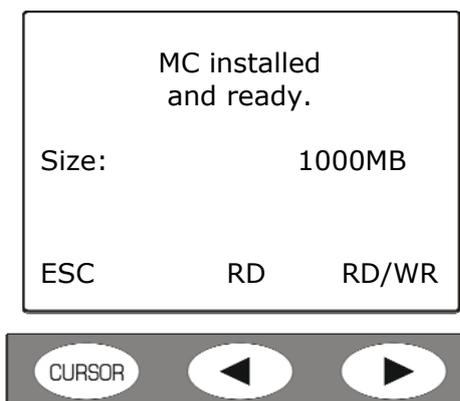

Press **RD/WR** to enable all the reading and writing functions.

Press **RD** alone to read the content of a card. The recording of new data is disabled: in this way it is avoided to overwrite the files already stored in the card.

The card is ready to be used.

Note: the HD2030's *"Initializing MC"* function also checks the read/wright speed of installed card. If the SD card fails this test for the first time, initialization function is repeated: may it happen more than three times, replace the card with a faster one. Do the same if the message *"Error reading memory"* appears during initialization procedure.

## RECORDING MODES

The HD2030 is able to perform three different types of storage:

- **Single Record**, it can be manual or automatic.
- **Single Profile** with a recording interval programmable from 1s to 1 hour. It can be manual or automatic.
- **Continuous Multi Profile**, with 1s recording interval or at intervals programmable from 10s to 1 hour.

The recordings are saved, for all the active channels, in the internal FLASH memory of the analyzer or in the SD memory card, following the setting of the parameter Menu >> Parameters>> Instrument >> Input/Output >> Memory.

Each recording is preceded by a summary screen reporting:

- the memory where the data are going to be saved (memory card or internal Flash memory);
- the sequential number that identifies the block of data;
- date and time;
- size of the file and memory space available.

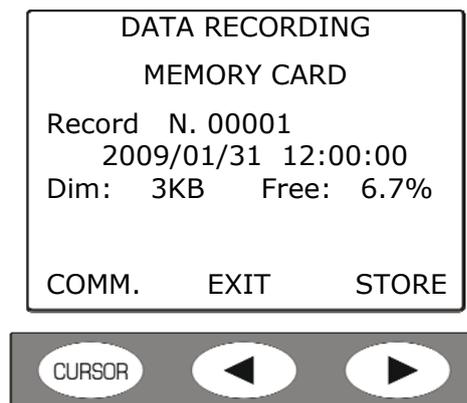

Pressing the **STORE** key (right arrow on the keypad), the data are saved.

Pressing the **EXIT** key (left arrow of the keypad), the instrument exits without saving and returns to measure mode.

Pressing the **COMM.** key (CURSOR key on the keypad), it is possible to save the data file adding a voice comment by connecting a microphone to the appropriate input on the front of the instrument.

Setting the parameter Menu >> Parameters >> Data Logger >> Profiles >> ADC Channels, in parallel with the storage of measurement parameters in the HD2030 analyzer's memory, it is also possible to store the accelerometers row signals. The parameter allows to select among the storage of all the channels of the analyzer, only one of the four channels or the first three channels (RIGHT input). The direct recording of the ADC channels can be activated only in the memory card and it is not available for the internal FLASH memory of the analyzer.

The **Auto-Store** function allows to **automatically store the global parameters**, i.e. integrated in all the measurement time.

To activate the recording of the global parameters, it is used the parameter Menu >> Parameters >> Data Logger >> Global >> Auto-Store.

Stored parameters are defined in the menu: Menu >> Setting >> Data Logger >> Global. Together with the global parameters are also recorded the average spectrum and the statistics.

## SINGLE RECORD

In this mode it is possible to memorize **in a single record**, the values visualized in the VLM, SPECTRUM, PROBABILITY and PERCENTILES screens.

### Manual Recording "Single record"

**Data are saved manually pressing the REC key for at least two seconds. This operation is allowed when the instrument is in STOP mode.**

Are stored:

- two VLM\_1 and VLM\_2 screens, whose measurement parameters are defined in Menu >> Parameters>> Vibration Analyzer.
- the average spectrum in octave or third octave bands, according to parameter Menu >> Parameters >> Spectrum Analyzer>> Order: ....integrated on the measurement time;
- probability distribution of chosen parameter in the profile screen (Menu >> Parameters >> Vibration Analyzer >> Profile:);
- percentile levels from L1 to L99 of chosen parameter in the profile screen.

### Automatic Recording "Single record"

To activate the automatic recording, enable from the menu the *Auto-Store* parameter: Menu >> Parameters >> Data Logger >> Global>> Auto-Store = ON.

The display shows the activation of the Auto-Store function with the alternated blinking of the REC and STOP symbols.

They will be recorded the two screens VLM\_3 and VLM\_4 (whose measurement parameters are defined in Menu >> Parameters >> Data Logger >> Global), the spectral analysis and the statistics.

The data are automatically recorded at the end of the set integration interval  $T_{int}$  or, before the  $T_{int}$  interval is elapsed, pressing the STOP key.

## SINGLE PROFILE

This mode allows the **storage of the time profile of the measurement parameter selected for the PROFILE screen**. The parameter is memorized at intervals programmable from 1s to 1 hour.

To make a **manual recording of a Single Profile** set:

- The single integration mode: Menu >>Parameters >> Instrument >> Measurement>> Integration Mode: SING
- The sampling interval of the time profile: Menu >> Parameters >> Instrument >> Measurement >> Profile Step: from 1 second to 1 hour.
- The measurement time: Menu >>Parameters >> Instrument >> Measurement >> Integration time: from 1 second to a maximum of 99 hours.
- The recording mode: Menu >>Parameters >> Data Logger >> Profiles >> Mode: PROFILE
- The parameter whose time profile has to be acquired: Menu >>Parameters >> Vibration Analyzer >> profile, choosing among those available.

**The recording starts pressing at the same time REC and START/STOP keys, and stops when the set measurement time  $T_{int}$  expires or pressing the START/STOP key.**

During the acquisition it is possible to temporarily **pause** the instrument pressing the PAUSE/CONTINUE key and start again the recording pressing a second time the same key.

In the recording it is also possible to add **markers** that will be saved together with the profile and that can be visualized with the Noise Studio software.

There are 9 available markers, each of them with maximum 15 characters.

To insert a marker, press the **REC** key during the recording: with the UP and DOWN arrows choose one of the 9 markers and confirm with the REC key. Press the **ESC** key to exit without memorizing the marker.

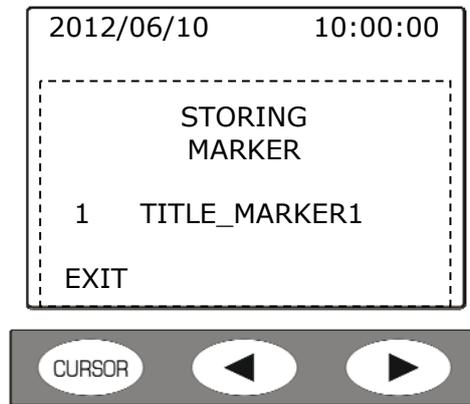

It is possible to assign a name to a marker from the instrument menu (see "Menu >> Parameters>> Data Logger >> Profiles" in "DESCRIPTION OF THE MENU FUNCTIONS" chapter) or by using the Noise Studio software.

#### **Automatic recording of a single profile**

If the **Auto- Store** function is enabled (Menu >> Parameters>> Data Logger >> Global >> Auto-Store = ON), at the end of chosen parameter's time profile storage, a single record is recorded containing:

- two screens VLM\_3 and VLM\_4 whose measurement descriptors are defined in Menu >> Parameters >> Data Logger >> Global;
- the average spectrum, integrated on the measurement time, in octave or third octave bands, according to the setting Menu >> Parameters >> Spectrum Analyzer >> Order;
- probability distribution of the chosen parameter in the profile screen (Menu >> Parameters >> Vibration Analyser >> Profile);
- percentile levels from L1 to L99 of the chosen parameter in the profile screen.

## **MULTI PROFILE**

**This mode allows to memorize the time profile of several parameters.**

Two recording modes are provided: one continuous and one at intervals, corresponding respectively to the setting of the single and multiple integration mode (parameter Menu >> Parameters >> Instrument >> Measurement >> Integration Mode).

**To perform a Multi Profile recording, set the following parameters:**

- The integration mode: Menu >>Parameters >> Instrument >> Measurement >> Integration Mode: SING o MULT.
- Recording mode: Menu >>Parameters >> Data Logger >> Profiles >> Mode: FULL

The measurement parameters that are memorized are indicated in the following table.

Parameter	MULTI PROFILE	
	<i>Single Integration</i>	<i>Multiple Integration</i>
VLM_1 and VLM_2 screens: - 3 parameters single axis - 3 parameters for sum and maximum value vectors	<b>X</b>	<b>X</b>
SPECTRUM screen: octave or third-octave band spectrum	<b>X</b>	<b>X</b>
STATISTIC and PERCENTILES screens: statistical analysis in 1dB classes with 1 second sampling frequency	---	<b>X</b>
Integration interval and calculation	1 second	Programmable from 10s to 1 hour (Instrument >> Measurement >> Int. Integration) with automatic reset of the parameters at the beginning of each interval.

The Multi Profile recording with **single integration** allows to memorize every second:

- The 3 instant or integrated parameters of the VLM\_1 screen calculated for all the measurement channels
- The 3 parameters of the VLM\_2 screen calculated on the vector formed by the first three channels (RIGHT input)
- The spectrum, in octave or third-octave bands.

The Multi Profile mode with **multiple integration** records, at intervals equal to the set integration time  $T_{int}$  (from 10 seconds to 1 hour):

- The 3 instant or integrated parameters of the VLM\_1 screen calculated for all the measurement channels
- The 3 parameters of the VLM\_2 screen calculated on the vector formed by the first three channels (RIGHT input)
- The spectrum, in octave or third-octave bands
- The statistical analysis in classes of 1dB with 1 second sampling interval.

All the measurement parameters, the spectra and the statistics are automatically reset at the beginning of each interval.

**The continuous recording starts pressing simultaneously the REC and START/STOP keys.**

**In the single integration mode, the acquisition stops when the set integration time  $T_{int}$  is elapsed (Menu >> Parameters>> Instrument > Measures > Int. Integration) or pressing the START/STOP key.**

**In the multiple integration mode, the recording must be ended manually pressing the START/STOP key.**

During the acquisition it is possible to temporarily **pause** the instrument pressing the PAUSE/CONTINUE key and start again the recording pressing a second time the same key.

In the recording it is also possible to add **markers** that will be saved together with the profile and that can be visualized with the Noise Studio software.

There are 9 available markers, each of them with maximum 15 characters.

To insert a marker, press the **REC** key during the recording: with the UP and DOWN arrows choose one of the 9 markers and confirm with the REC key. Press the **ESC** key to exit without memorizing the marker.

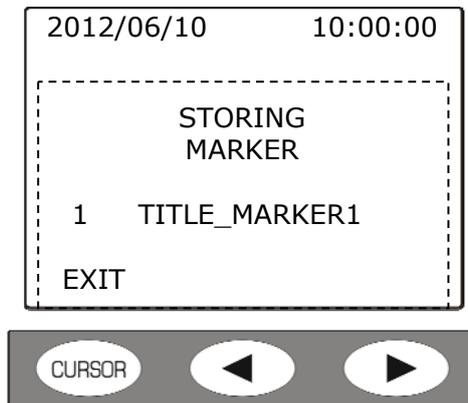

It is possible to assign a name to a marker through the instrument menu (see "Menu >> Parameters >> Data Logger >> Profiles" in "DESCRIPTION OF THE MENU FUNCTIONS" chapter) or by using the Noise Studio software.

If the **Auto-Store** mode is enabled (Menu >> Parameters >> Data Logger >> Global >> Auto-Store = ON) at the end of the Multi Profile storage, a single record is stored containing:

- two screens VLM\_3 and VLM\_4 whose measurement parameters are defined in Menu >> Parameters >> Data Logger >> Global;
- the octave or third octave average spectrum, calculated on the measurement time, according to the setting Menu >> Parameters >> Spectrum Analyzer >> Order;
- the probability distribution of the chosen descriptor in the profile screen (Menu >> Parameters >> Vibration Analyser >> Profile);
- percentile levels from L1 to L99 of the parameter chosen in the profile screen.

#### RECORDING OF VOICE COMMENTS

The HD2030 can be used as an audio recorder connecting an external microphone (code HD2030AM) at the MIC input. The recording can be saved as single audio file or it can be associated with a data file as vocal commentary.

**To record audio only**, keep the REC key pressed for at least two seconds when the instrument is in STOP mode. The following screen appears:

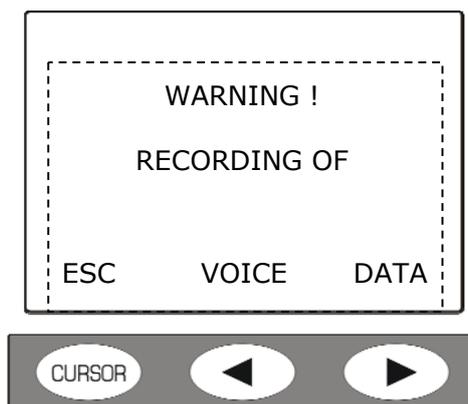

Press the VOICE key. The recording starts. To finish the operation, press the STOP key.

**To add a voice comment to a data file**, connect a microphone to the appropriate MIC input on the instrument front and, when you are going to save, press the COMM (comment) key.

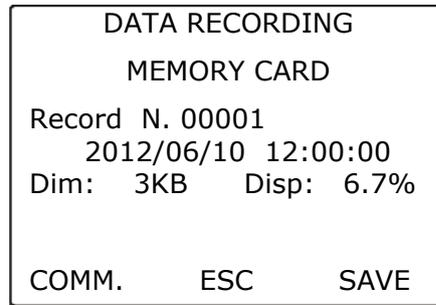

To end the audio comment recording and save the data file, press the STOP key.

The recordings can be listened directly from the instrument equipped with headphones or through the Noise Studio software.

See the details in the Memory Navigator Program description at paragraph "4) To listen vocal commentaries").

## PROGRAMS DESCRIPTION

The HD2030 analyzer has several programs that are accessed by Menu>> Programs. To start a program, select it with the UP and DOWN arrow keys and press ENTER.

The programs available are:

- **Memory Navigator:** it allows to examine what it is stored in the internal FLASH memory of the instrument and in the memory card. It is also possible to listen to the audio recordings and the vocal commentaries associated with the data files using the headphones.
- **Setup Management:** it allows to save or load the analyzer settings. To facilitate the choice, each setup has a title.
- **Calibration:** it sets the sensitivity of the accelerometers connected to the instrument, both through manual insertion of the calibration values and through the measurement of the acceleration produced by a vibrations generator.
- **Diagnostic Check:** it checks the main functions of the instrument.
- **Sensors Config.:** insertion and modification of the parameters of the sensors that can be connected to the analyzer.
- **Initialize MC:** it deletes the data in the memory card and set it for the use with the HD2030.

### MEMORY NAVIGATOR PROGRAM

The Memory Navigator Program allows to operate in the internal FLASH memory and in the external Memory card.

To enter the Memory Navigator Program, press the MENU key: Menu >> Programs >> Memory Navigator.

If the Memory card is present, the following screen appears:

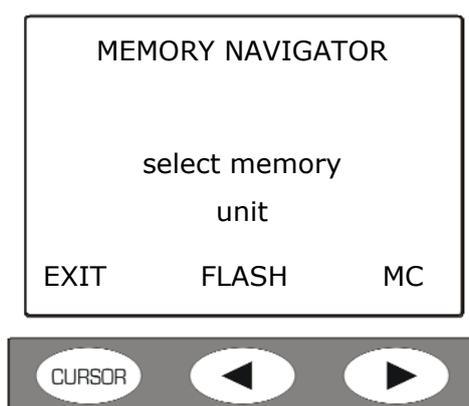

Press the **FLASH** or **MC** keys to respectively manage the internal memory of the instrument or the memory card.

If there is *no* Memory Card, the following screen appears:

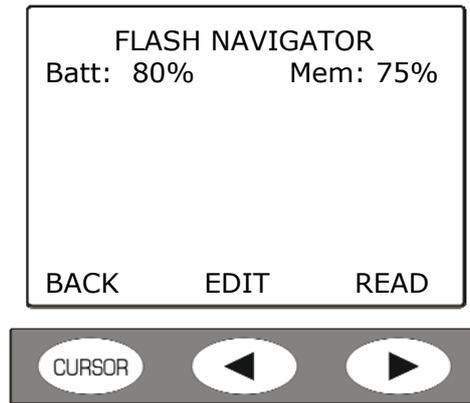

In the **internal FLASH memory** it is possible:

- to review the memorized files.
- to copy the single recording or all the files from the internal memory to the memory card.
- to erase all the memory content. **It is not provided the possibility to erase the single files in the internal memory.**

In the **Memory Card** it is possible:

- to review the memorized files.
- to listen to the vocal recordings.
- to erase single files contained in the Memory Card. To erase all the Memory Card content, run the program "Menu >> Programs >> Initialize MC", as described below.

Note: the deleted files in the Memory Card are still in the card memory, even if new recordings are added; this allows an eventual recovery through the Noise Studio software supplied with the analyzer.

To clear the Memory Card it is always possible to use the program "Format Memory Card" in the Noise Studio software. See the chapter "USE OF THE EXTERNAL MEMORY CARD".

### 1) To review a file saved in the internal Flash memory

From measure mode, press in sequence the buttons: Menu>> Programs>> Memory Navigator and select the internal Flash memory.

The following screen appears:

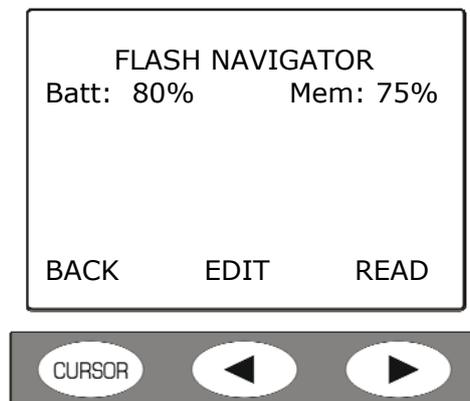

Press the **READ** key: the display shows the characteristics of the first file in memory.

To scroll the memory and display the properties of the other files, press the **RIGHT** arrow key. After the last file is visualized, the display returns to the starting screen. The properties of a file in the memory appear like in the following example:

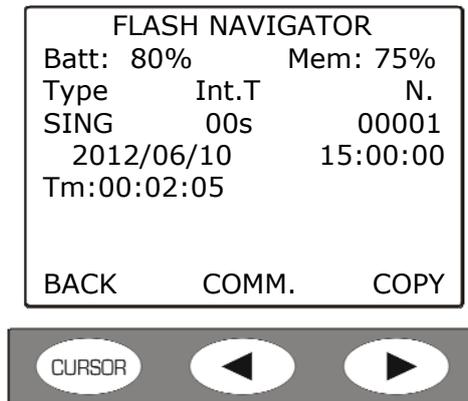

For each file are indicated:

- **Type** indicates the file type: single report (SING), single profile (PROF) or multi profile (REP).
- **Int.T** is the integration interval.
- **N** is the sequential number that identifies the file.
- **Tm** represents the total recording time.

**To visualize the current file content, press the ENTER key:** the STOP symbol alternates with the R letter (Replay).

During the replay it is possible to use the **MODE** key to display the different measure modes: VLM, PROFILE, SPECTRUM, PROBABILITY, PERCENTILES.

In the same way, with the **CHN** key it is possible to scroll the different measurement channels.

To stop or start again the review, use the PAUSE/CONTINUE key.

While the replay is paused, it is possible to visualize the next data pressing the START key.

If the START key is hold pressed in pause mode, the fast replay mode is entered.

At the end the instrument enters the STOP status.

**To exit from REPLAY mode, press the MENU key.**

**The review operation mode depends on the memorized file type** (see the chapter "RECORDING MODE"):

- **"Manual single record" Recording**  
The file is "Single Report" type: when the ENTER key is pressed, the parameters of the VLM\_1 and VLM\_2 screens are automatically loaded and displayed.
- **"Automatic single record" Recording**  
For the recording the Auto-Store function has been enabled, the file is "Single Report" type: When the ENTER key is pressed, the global parameters of the VLM\_3 and VLM\_4 screens are automatically loaded and displayed.
- **"Manual Single profile" Recording**  
The time profile of a single parameter has been memorized. Pressing the ENTER key, the display shows the Profile screen with the timer at 0.

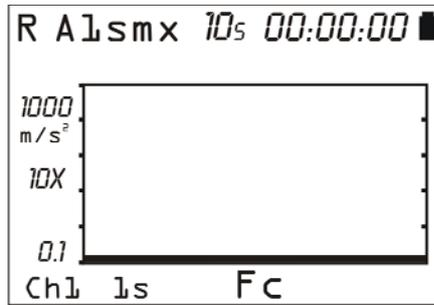

When the START key is pressed, the profile is reviewed automatically. It is possible to switch from a measurement channel to another one with the CHN key but there are no other active screens because this mode records only the time profile of the four channels.

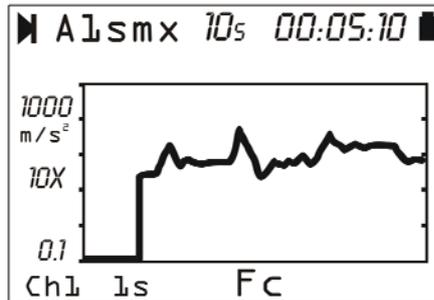

- **“Automatic Single Profile with Auto-Store” Recording**

A single profile recording enabling the Auto-Store function was done. When the ENTER key is pressed, the global parameters of the VLM\_3 and VLM\_4 screens are automatically loaded and displayed: the GLOBAL indication appears at the top of the display. With the MODE key it is possible to scroll the spectrum, probability and percentiles screens calculated on the global parameters:.

Pressing the START key, the profile is reviewed automatically. It is possible to switch from a measurement channel to another one with the CHN key.

- **“Multi profile with single integration” Recording**

A multi profile recording with single integration mode was done. The data file includes the VLM\_1 and VLM\_2 screens and the spectrum. When the ENTER key is pressed, the instrument goes into VLM\_1 screen: at the top it appears the indication “PROFILE”.

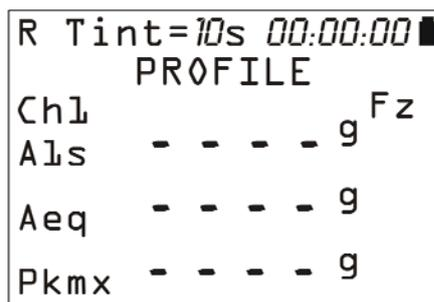

Pressing the START/STOP key, the data replay starts. With the MODE key it is possible to switch from a screen to another one, with the CHN key from a measurement channel to another one.

- **“Multi profile with multiple integration” Recording**

A multi profile recording with multiple integration mode was done. The data file includes the VLM\_1 and VLM\_2 screens, the spectrum and the statistics.

When the ENTER key is pressed, the instrument goes into VLM\_1 screen: at the top appears the indication “REPORT”.

```

R>Tint=10s 00:00:00 █
REPORT
Ch1      Fz
Als      - - - - g
Aeq      - - - - g
Pkmx     - - - - g

```

The "Tint=" tag blinks to signal that the integration is multiple. When the START/STOP key is pressed, the instrument displays the data related to the first integration interval and enters the pause mode. With the MODE key it is possible to switch from a screen to another one, with the CHN key from a measurement channel to another one. While the replay is paused, it is possible to display the following data pressing the START key. Holding pressed the START key while in pause mode, the fast replay mode is entered. Pressing the PAUSE/CONTINUE key, the review proceeds up to the end.

- **"Multi Profile with single or multiple integration with Auto Store" Recording**

The two previous modes can be integrated during the recording phase with the addition of the Auto-Store function: in this case, when the ENTER key is pressed, the global parameters of the VLM\_3 and VLM\_4 screens are automatically loaded and displayed; the GLOBAL indication appears at the top of the display. With the MODE key it is possible to switch from spectrum, probability and percentiles screens.

Pressing the START key, the parameters are reviewed as described in the previous two points.

## 2) To review a file saved in the Memory Card

From measure mode, press in sequence the keys: Menu >> Programs >> Memory Navigator.

If a Memory Card is present, it appears the screen to select the memory to review: press **MC** to select the Memory Card.

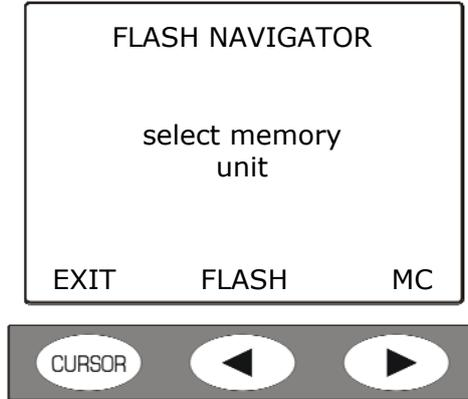

The following screen with the file list appears:

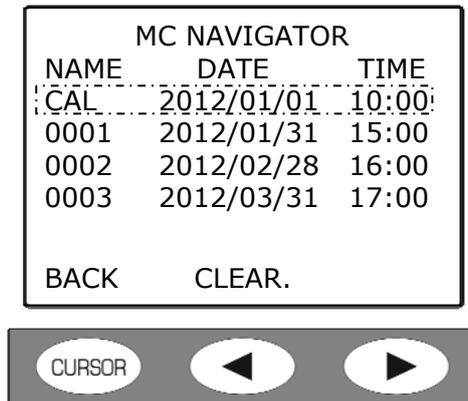

Note: the first file of the list called "CAL" is the file of sensors calibration. It is a read/write protected file, no operations are allowed on this file.

With the UP and DOWN arrow keys, select the file to be visualized and press ENTER.

The properties of the selected file are indicated:

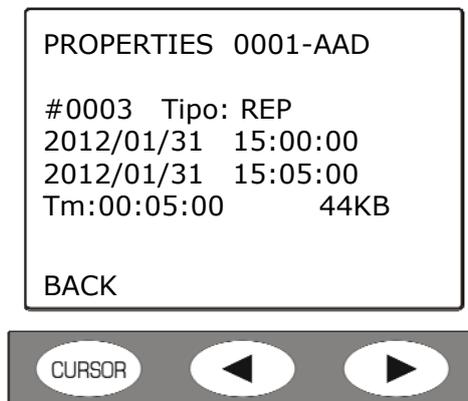

For each file are indicated:

- The sequential number in the browser file list ("0001" in the example, next to "Properties").
- three characters code ("AAD" in the example) with the following meaning:

- The first character identifies the *recording type*:
  - **S** *Single* type recording
  - **A** *Autostore* type recording
  - **M** *Multi* type recording
  - **R** *Report* type recording
  - **V** *Audio* file recording. In this case the second character is **A**.
- The second character, if present, can be **A** only; it identifies a vocal recording or a file with an audio comment attached.
- The third character, if present, can be **D** only; it identifies a file that includes the ADC channels data.
- **#** is the sequential number given to a specific file and identifying it.
- **Type** indicates the file type: if single report (SING), single profile (PROF) or multi profile (REP). If there is also an audio comment, the "+AUDIO" indication appears.
- **Date and time** of file opening.
- **Date and time** of file closing.
- **Tm** represents the total recording time. On the side it is indicated the file dimension.

**To display the content of the current file, press the ENTER key:** the STOP symbol alternates with the R letter (Replay).

During the replay it is possible to use the **MODE** key to visualize the different measurement modes: VLM, PROFILE, SPECTRUM, PROBABILITY, PERCENTILES.

In the same way, with the CHN key it is possible to scroll the different measurement channels.

For the details on how to proceed to visualize the memorized data, see the detailed description reported in the previous point.

**To exit from REPLAY mode, press the MENU key.**

### 3) File management in the internal Flash memory

The allowed operations on the files stored in the internal memory are the copy of a file or of the entire internal memory into the Memory Card, and the memory clear. It is not possible to delete single files in the internal memory.

Press in sequence the keys: Menu >> Programs >> Memory Navigator.

It appears the screen:

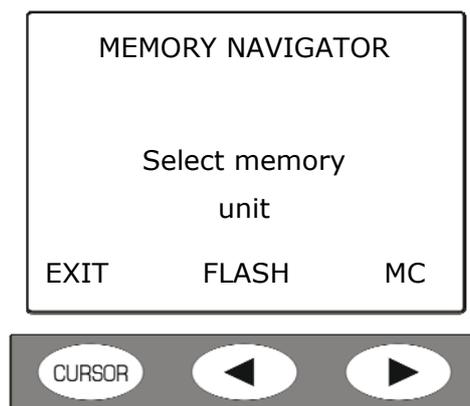

Press the **FLASH** key to access to the internal memory of the instrument.

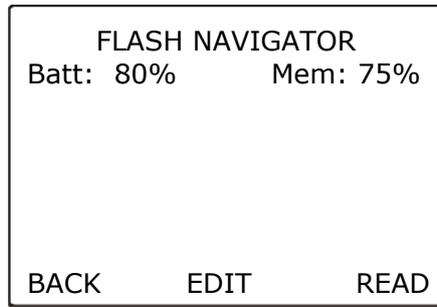

Press the **EDIT** key to enter the submenu for the management of the memorized files.

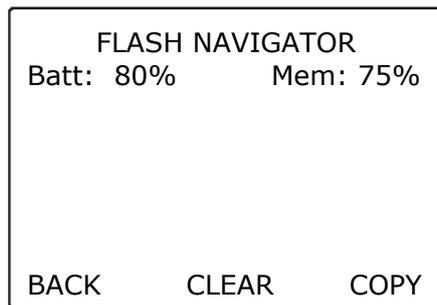

**With the CLEAR. Key all the FLASH memory content is deleted.**

**With the COPY key all the FLASH memory content is copied into the Memory Card.**

When one of the two keys is pressed, the instrument asks to confirm the selected operation, pressing YES.

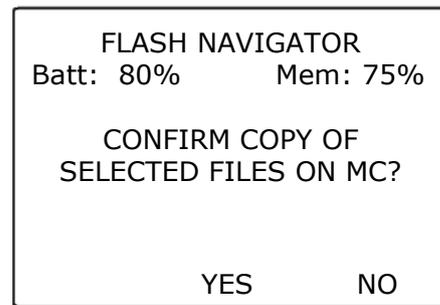
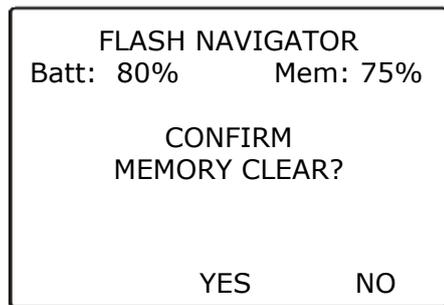

**To copy a single file from the internal memory into the Memory Card, select in sequence the keys: Menu >> Programs >> Memory Navigator.**

It appears the screen:

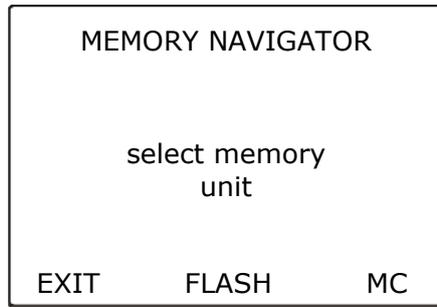

Press the **FLASH** key to access to the internal memory of the instrument.

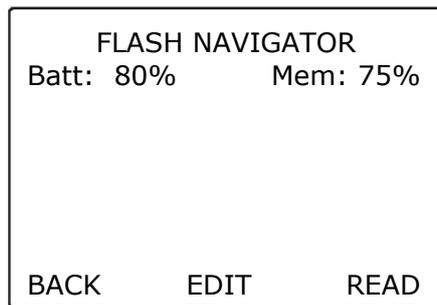

Press READ and with the UP and DOWN arrow keys select the file to copy.

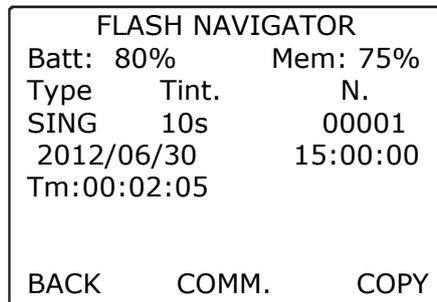

Press the COPY key and confirm the operation in the next screen.

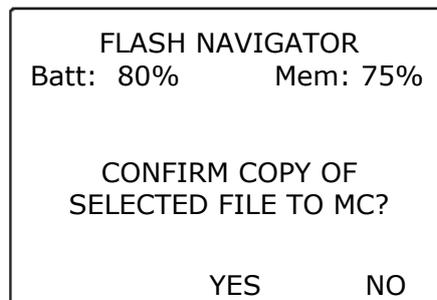

Press YES to copy, NO to go back to the previous screen without copying.

#### **4) To listen to the voice comments**

The voice comments can be listened again through Noise Studio Software or directly from the HD2030 if equipped with headphones (code HD2030AM).

- Connect the headphones to the appropriate connector on the front of the instrument.
- Select in sequence the keys: Menu >> Programs >> Memory Navigator.
- Select the internal memory bank (FLASH) or the external Memory Card (MC).
- Select with the UP and DOWN arrow keys the file with the comment and press ENTER to load it.
- Press the COMM key to listen to the vocal comment.
- With the << and >> arrows of the keypad it is possible to adjust the volume of the headphones.
- Press STOP to finish in advance the listening of the comment.
- Press BACK to go back to the main screen of the Browser.

End of the procedure.

## SETUP MANAGEMENT PROGRAM

This program allows to choose one of the 10 reference setups stored in the HD2030 analyzer. To rapidly identify the desired one, to each setup is associated with a title.

The PC software Noise Studio allows to edit the setups, to save them into the PC memory and to load into the instrument memory the ones you want to use.

Each setup is associated with a configuration for the sensors to be connected to the RIGHT and LEFT inputs (see the Sensor Configuration Program).

Once the setup is loaded in the instrument, it is possible to manually modify the settings, including the sensors configuration: once edited the setup can be stored inside any of the 10 reference setups.

Note: to proceed with the creation of a new setup to load in the instrument, it is necessary to have installed in the PC the Noise Studio software.

### 1) How create a new setup with Noise Studio Software

Proceed in the following way:

- Connect the analyzer to the PC with the serial or USB cable.
- Start the Noise Studio software.
- Press *Instrument management* key in Noise Studio: start the connection with the *Connect* key (for details on how to connect, see the software manual).
- Press the *Instrument configuration* tool in Noise Studio: the software downloads the current settings of the analyzer.
- Modify the *General, Channels and Sensors* screens in Noise Studio according to your needs:
  - In the *General* screen the system, input/output and measure parameters can be set.
  - In the *Channels* screen the measurement variables for the different screens (VLM, profile, spectra, global parameters), the recording modes and the trigger can be selected.
  - In the *Sensors* screen the accelerometers to use during the test can be configured. Insert all the parameters and save the configurations pressing the *Save Config. Key*, assigning to each configuration a number from 1 to 9 (see in the following of this chapter the specific program *Sensors Configuration*).
- Select the *Predefined* screen and press *Save Current Settings*: insert a name and a description (optional) to identify the setup.
- Press the "Copy custom settings in the predefined setups of the instrument" key. In this way the just created setup is added to the setups list in the memory of the instrument and can be selected directly from the instrument menu, without the need to connect instrument to a PC.
- To make the current setup active, push *Apply All* key in Noise Studio.

The setup is loaded into the instrument memory, ready to be used.

### 2) How to load a new setup

To apply a setup previously stored in the instrument's memory, press the following sequence of keys: MENU >> Programs>> Setup Management.

- With the UP and DOWN arrows select the setup to apply: press ENTER to confirm.
- In the following screen, press the LOAD key to apply the settings of the new setup.

```

SETUP MANAGEMENT
2012/05/30      12:00:00

      SETUP N.01
TEST_001
2012/05/01      10:00:00

BACK      STORE      LOAD

```



- The next screen visualizes the setup features of the sensor for the RIGHT input:

```

CONFIG RIGHT. #02
PROD:  DELTA OHM
MOD:   ACC_TRI
S.N.:  123456
TYPE:  ACC TRI
SENS:  10mV/g  CAL
RANGE: 500 gpk

SEL.      PREV.      NEXT

```



- Press **SEL** to confirm, **PREV** or **NEXT** to scroll the list of the sensors that are in the memory. Following are the setup features of the sensor for the LEFT input.

```

CONFIG LEFT . #02
PROD:  DELTA OHM
MOD.:  ACC_MONO
S.N.:  654321
TYPE:  ACC MON
SENS:  100mV/g  CAL
RANGE: 100 gpk

SEL.      PREV.      NEXT

```



- Press **SEL** to confirm, **PREV** or **NEXT** to scroll the sensors list of the sensors that are in the memory.

Now the instrument is ready to perform a new measurement.

### 3) How to save an instrument configuration in a setup

A special configuration of the instrument can be saved in one of the ten setups available in the memory to be recalled at a second time.

Proceed as follows:

- Select through the menu the different instrument parameters, the sensors configuration, the measurement and recording modes.
- It is possible to start from an already memorized setup, loading it in the memory as described in the previous paragraph.

- Press in sequence the keys: MENU >> Programs >> Setup Management.
- With the UP and DOWN arrows, select the setup number to be assigned to the new configuration: the current configuration will be overwritten by the new one so do not select a setup you want to keep. Press ENTER to confirm.
- It appears the screen with the name of the current setup that will be overwritten by new one.

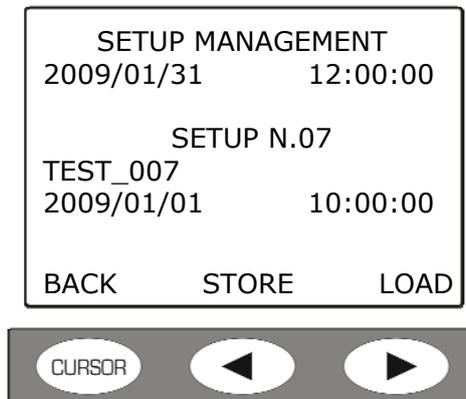

- Press the STORE key.
- The screen for the insertion of the title to apply to the new setup appears:

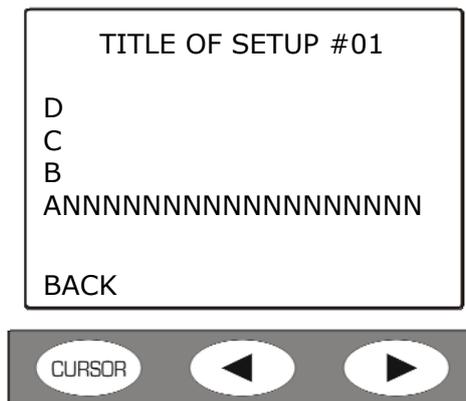

- With the UP and DOWN arrows, select the first character and confirm it with ENTER.
- The cursor skips to the second character.
- Repeat the selection with the UP and DOWN arrows and confirm with ENTER. Proceed in the same way for the other characters of the title.
- Inserting a SPACE (blank) the remaining characters of the title are cancelled.
- Press RET to save.
- Press ESC to exit from the Setup Management program

#### 4) How to modify a setup in the memory

The setups in the memory can be changed directly through the menu of the instrument (for the change of a setup through the Noise Studio Software, see point 1 of this paragraph).

Proceed in the following way:

- Start the setup management program pressing in sequence the keys: MENU >> Programs >> Setup Management.
- Load the setup to modify following the steps indicated in point 2 of this paragraph.
- Modify the instrument configuration as desired (for example: displayed units, parameters of the menu, recording mode,...).
- Go back to the setup management program pressing in sequence the keys MENU >> Programs >> Setup Management. With the UP and DOWN arrows select again the setup previously loaded and confirm with ENTER.

- In the following screen, press the STORE key.

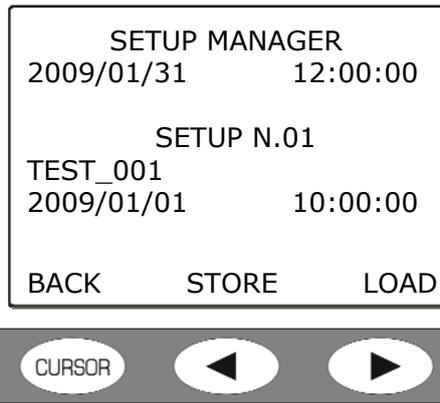

- The new settings are saved in the place of the previous ones.
- It appears the screen for the insertion of the title to apply to the updated setup:

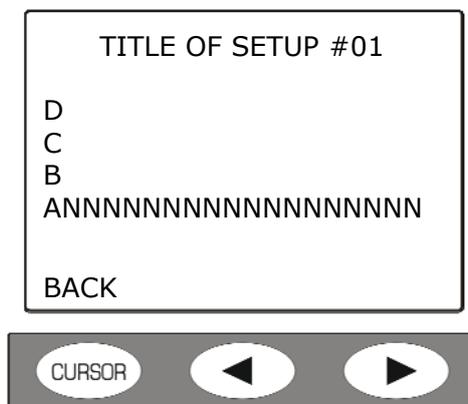

- If it is desired to maintain the name of the previous setup, press RET and then ESC to exit from Setup management, otherwise, with the UP and DOWN arrows, select the first character and confirm it with ENTER.
- The cursor skips to the second character.
- Repeat the selection with the UP and DOWN arrows and confirm with ENTER. Proceed in the same way for the other characters of the title.
- Inserting a SPACE (blank) the remaining characters of the title are cancelled.
- Press RET to save.
- Press ESC to exit from the Setup Management program.

The setup modification procedure is completed.

## CALIBRATION PROGRAM

This program calibrates the sensors connected to the HD2030 analyzer.

It is possible to manually insert the calibration parameters of the accelerometers using the values indicated on the certificates or calibration sheets, or using a vibrations generator specific for the calibration of the accelerometers.

The calibration parameters are saved in a specific log file where the last 120 calibrations performed are stored. When the instrument is connected to the PC through the Noise Studio software, this file is automatically downloaded and saved in the PC as a reference for the documentation of the measurements performed with the instrument.

Any measurement made with the HD2030 analyzer, therefore, will be associated with a calibration according to the date.

## 1) Calibration of a sensor through the direct input of parameters

If the calibration data of the sensor are available, proceed in the following way:

- Start the calibration program of the sensors pressing in sequence the keys: MENU >> Programs >> Calibration.
- The main screen appears:



The indicated date refers to the last saving of the log file. On the left side are reported the manufacturer and the name assigned to the monoaxial sensor, and on the right side the correspondent information for the triaxial one.

- Press the *LEFT* Key to select the monoaxial sensor, *RIGHT* for the triaxial one. The screen that resumes the current data of the selected sensor appears:
  - manufacturer,
  - type,
  - name,
  - serial number,
  - sensitivity expressed in mV/g.



- To insert manually the sensitivity, press the SENS key.
- If *the sensor is triaxial type*, a sensitivity for each axis must be inserted: with the UP and DOWN arrows select the first axis and confirm with ENTER.

```

CALIBRATION
DELTA OHM  ACC_TRI
ACC_T      123456
Axis: 3
SENS:  10mV/g  Axis: 1

Calibration Type
EXIT      SENS.  MEAS.

```



- The following screen appears:

```

CALIBRATION
DELTA OHM  ACC_TRI
ACC_T      123456
Axis: 3
10.15mV/g
Sensitivity +-
BACK

```



- With the UP and DOWN arrows modify the proposed value and press ENTER. At the following request of confirmation, press again ENTER.

```

CALIBRATION
DELTA OHM  ACC_TRI
ACC_T      123456
Axis: 1
SENS:  10mV/g  Axis: 1

Calibration Type
BACK

```



- Select the other axes and proceed in the same way. Press BACK To go back to main screen.
- If the sensor is monoaxial, the sensitivity is unique: only one value must be inserted.

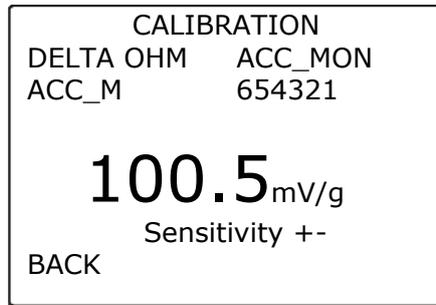

- With the UP and DOWN arrows change the proposed value and press ENTER. At the following request of confirmation, press again ENTER. Press BACK key to go back to main screen
- From the main screen, press ESC to exit from the calibration program.

## 2) Calibration of a sensor through the vibrations generator

If a calibrator is available, proceed in the following way:

- Set the acceleration level of the calibrator through the item Menu> Parameters > Calibration.
- Start the sensors calibration program pressing in sequence the keys: MENU >> Programs >> Calibration.
- The main screen appears:

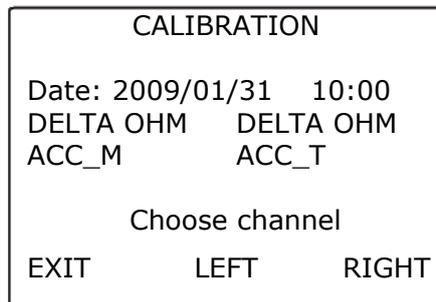

The indicated date refers to the last saving of the log file. On the left side are reported the manufacturer and the name assigned to the monoaxial sensor, and on the right side the correspondent information for the triaxial one.

- Press *LEFT* Key to select the monoaxial sensor, *RIGHT* for the triaxial one. The screen that resumes the current data of the selected sensor appears:
  - manufacturer,
  - accelerometer type,
  - name,
  - serial number,
  - sensitivity expressed in mV/g.

```

CALIBRATION
DELTA OHM  ACC_TRI
ACC_T      123456
SENS:     10mV/g

          Calibration Type
EXIT      SENS.  MEAS.

```



- Apply the transducer to the calibrator and press the MEASURE key: the level that appears is the calibrator nominal value.  
With the RIGHT and LEFT arrows the measure unit can be changed between  $g$  and  $m/s^2$ .
- *If the sensor is triaxial type*, the three axes have to be calibrated separately: with the UP and DOWN arrows select the first axis and confirm with ENTER.

```

CALIBRATION

Level      10.00 m/s2
          Axis: 1

          Select axis

BACK.

```



- The following screen appears:

```

CALIBRATION

Level      10.00 m/s2

A1s  Fz  - - - -  m/s2
          Turn On
          calibrator
          NEXT      EXIT

```



- Switch on the calibrator and press FORWARD.

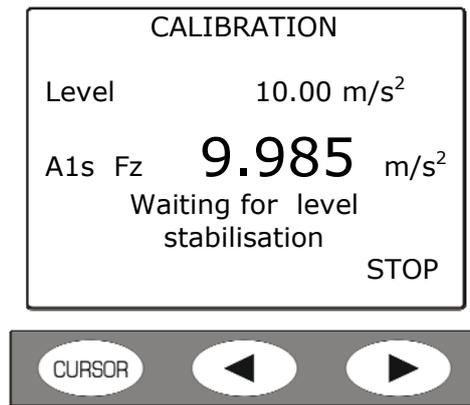

- The instrument verifies that the signal level is stable and then asks to confirm the measured value.

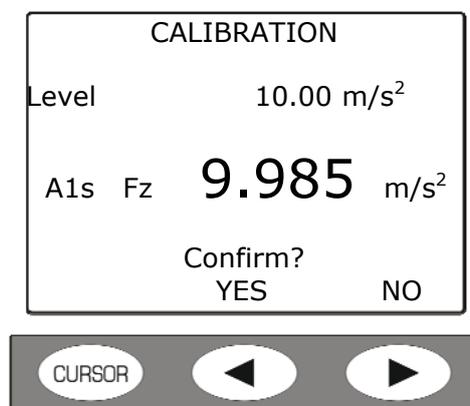

- Pressing YES the current value is memorized.
- If the sensor is triaxial, the procedure has to be repeated selecting the other two axes: repeat the operation from the beginning.
- From the main screen, press ESC to exit from the calibration program.

## DIAGNOSTIC CHECK PROGRAM

This program perform a check of the main functions of the HD2030 analyzer.

The following functional parameters are checked, in automatic sequence:

- *Power Supply*: it checks that the voltage supplied to the instrument allows the measurements execution. If this point fails, replace the batteries and repeat the test.
- *IEPE Power Supply*: it checks that the power supply of the accelerometers is within the technical specifications.
- *Accelerometers Polarization*: it checks that the polarization voltage of the connected accelerometers is within the technical specifications.
- *DSP Working*: it checks that the analog to digital conversion and the DSPs are able to transmit the measures to the microprocessor.
- *Environmental Parameters*: it checks that the environment temperature is within the working specifications of the analyzer.

When one of the checks fails, it is displayed the list of the checks done and the steps that failed.

In this case it is always suggested to repeat the diagnostic check and, in case of confirmation, contact the technical service.

In case of failure of the power supply test, replace the batteries before repeating the diagnostic check.

To perform the diagnostic test, proceed as follows:

- Connect the accelerometers to the appropriate inputs and switch on the instrument.
- Start the diagnostic test pressing in sequence the keys: MENU >> Programs >> Diagnostic check.
- The test program starts and the different steps are executed:

<b>HD 2030</b>	
DIAGNOSTIC TEST	
2011/10/01 10:00:00	
Power supply	OK
IEPE power supply	OK
Accelerometer Pol	TEST
	EXIT



- At the end it is displayed the test report; if at least one of the steps failed, the message "FAULT IN DIAGNOSTIC CHECK!" appears. The passed steps are marked with **OK**, the failed steps are marked with **NO**.

Power Supply	OK
IEPE power supply	OK
Accelerometer Pol.	<b>NO</b>
DSP engine	OK
Amb.Parameters	OK
Diagnostic error	
	EXIT



- If all the steps have been completed without faults, it appears the message "DIAGNOSTIC CHECK DONE".

<b>HD2030</b>	
DIAGNOSTIC TEST	
2011/10/01 15:30:00	
Diagnostic check done	
	EXIT



- Press ESC to exit. To repeat the test, enter the menu again as described above.

The test procedure is completed.

## SENSORS CONFIGURATION PROGRAM

This program allows to configure the sensors that will be used for the measurements with the HD2030 analyzer.

It is possible to memorize up to 9 different sensors for the right input and 9 for the left input. The sensors related to the right input are **triaxial** type while the ones related to the left input are **monoaxial** type.

The parameters of the sensors are saved in a specific file in the internal memory of the analyzer and, if present, they are also saved in the Memory Card.

The requested parameters are:

- **Manufacturer**
- **Model**
- **Serial Number**
- **Type:** triaxial or monoaxial accelerometers for the right input and monoaxial for the left input.
- **Nominal Sensitivity:** Sensitivity nominal factor of the accelerometer (mV/g)
- **Range:** the maximum acceleration value measurable (g pk)

At startup the instrument load the file with the parameters of the sensors and it is requested to select a configuration for each of the two sensors. With the PREV. and NEXT. keys of the keypad it is possible to scroll the different sensors, and with the CURSOR key a sensor for each input can be selected.

The blinking warning "NO CAL" next to the nominal sensitivity value indicates that, for that sensor, the calibration data are missing: in this case the nominal sensitivity is used.

The same process is used when a complete setup is loaded (see the Setup Management program description): the instrument verifies the existence of the calibration file for the two accelerometers included in the selected setup. If the sensors have been calibrated, the sensitivity parameters are loaded automatically, otherwise it will be used the nominal sensitivity associated with the configuration.

**Note:** even if it is possible to operate directly on the instrument, the management of the sensors configuration can be more easily done with the PC software Noise Studio (see the details in the software manual).

To configure the sensors, proceed as follows:

- Connect the accelerometers to the appropriate inputs and switch on the instruments.
- Start the program pressing in sequence the keys: MENU >> Programs >> Sensors Config..

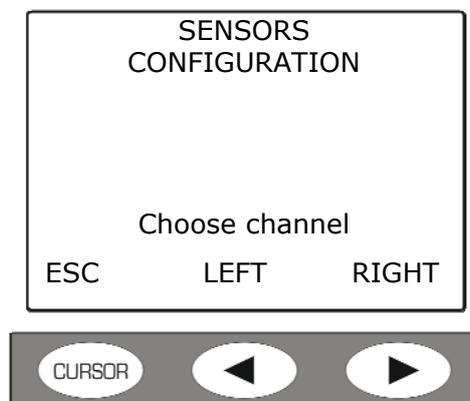

- Select the channel where it is connected the sensor to configure.
- A screen similar to the following appears:

CONFIG.	RIGHT. #01
PROD:	DELTA OHM
MOD:	ACC_ABC
SERIAL N.:	654321
TYPE:	ACC TRI
SENS:	10mV/g CAL
RANGE:	500 gpk
BACK.	



- With the right and left arrows, select the sensor among the nine available.
- With the UP and DOWN arrows, select the row to change.
- Press ENTER to go to the parameter of the selected row.
- With the UP and DOWN arrows, set the desired value.
- Press ENTER to confirm.
- Repeat for all the parameters.
- Press RET (CURSOR key) to go back to the initial screen and select the other input.
- Repeat the steps described above for the sensor connected to the second input.
- Press ESC to go back to measurement mode.

The configuration process is completed.

#### MC INITIALIZATION PROGRAM

This program prepare the memory card for the use with the HD2030 and erases the files previously stored in the card. For the details see the chapter dedicated to the memory card.

Proceed as follows:

- After inserting the card in the slot placed in the front of the analyzer, switch on the instrument.
- When the "MC installed and ready to use" message appears, press the **RD/WR** key to enable all read and wright functions.
- Start the program MENU >> Programs >> MC Initialization.

INITIALIZE MC	
Batt: 90%	Mem: 50%
CONFIRM MEMORY CLEAR?	
YES	NO



- Press YES to proceed, NO to cancel the operation.
- At the end the following screen appears:

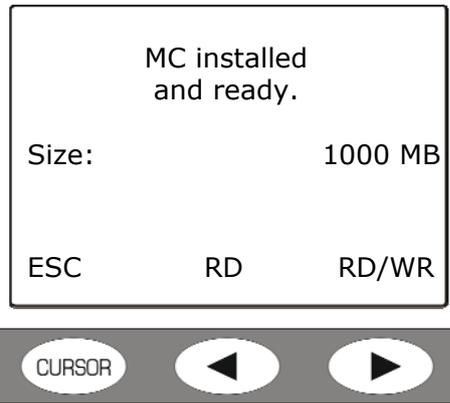

Press **RD/WR** to activate all the reading and writing functions.

The card is ready for the use.

## DESCRIPTION OF THE MENU FUNCTIONS

The menu provides all the functions to set the parameters for the instrument functioning. The menu is entered with Menu key> Parameters.

The access to the menu is allowed also with the instrument in measure mode, while for the modification of a parameter the instrument must be in stop mode, If not, it appears a message requesting to stop the current measurement: WARNING! Stop the measure to proceed".

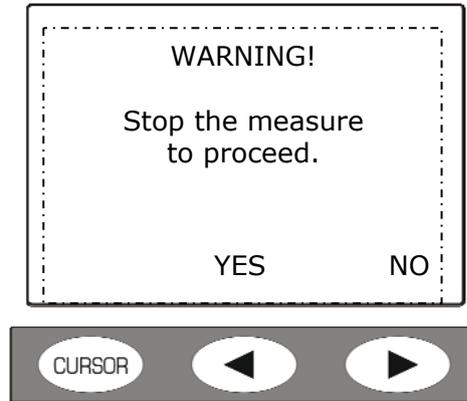

Pressing YES the instrument enters the STOP mode and it is possible to proceed with the modification of selected parameter.

Some of the parameters listed in the menu (for example the integration time Tint, VLM screen parameters,...) are editable directly from the measurement screens: see the chapter "DESCRIPTION OF THE SCREENS" dedicated to the different modes of visualization.

The menu has a multi-level structure: with main categories and submenus. To select a menu item use the UP and DOWN arrows: the selected item blinks.

If the parameter placed on the right of a menu item does not blink, it means that the item cannot be modified.

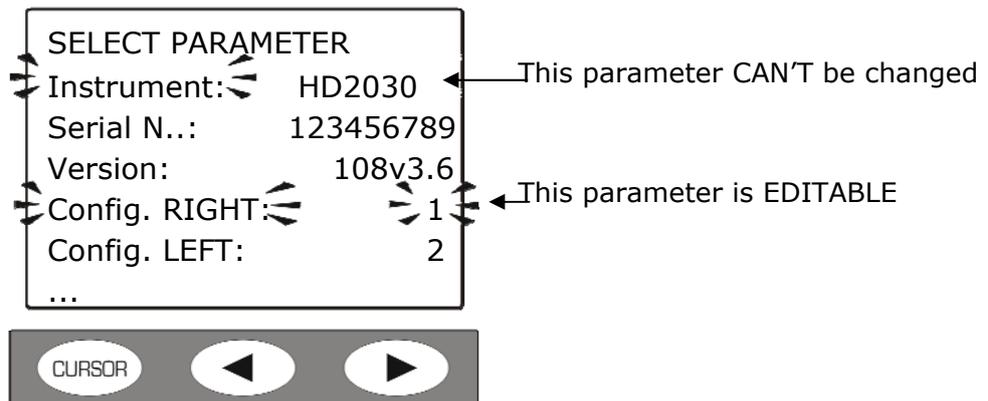

Use the ENTER key to access the selected submenu or to modify the selected parameter.

The selected blinking parameter can be modified with the UP and DOWN arrows: to confirm the new value, press the ENTER key, while to cancel the modifications press the MENU key.

To exit from a menu and go back to the upper level till returning to the measurement screen, use the MENU key.

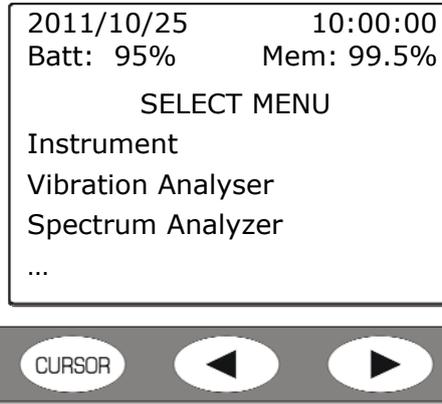

Entering the menus, it is visualized the current date and time and, in the next line, the remaining charge of the batteries and the memory space available. The memory space refers to the external card, if any, otherwise to the internal Flash memory.

The message "SELECT MENU" becomes "SELECT SUB MENU" when the meter is inside a sub menu.

The points at the end of a list indicate that there are other items following the visible ones: to display them, press the DOWN arrow key.

Pressing MENU once, it appears the screen that allows to choose to access the **Parameters** of the instrument or the **programs**.

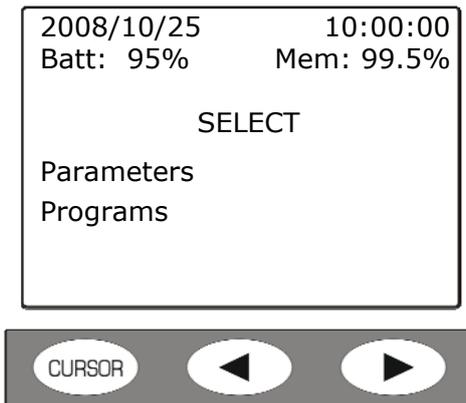

The following table lists the available menus for the instrument setting.

MENU	DESCRIPTION
<i>Instrument:</i> <ul style="list-style-type: none"> <li>• Identification</li> <li>• System</li> <li>• Input/Output</li> <li>• Measurements</li> </ul>	Identification of the instrument and configuration of the accelerometers. Date and time, type of batteries and display settings. Reading of the accelerometers polarization voltages. Menu language setting. Setting of the automatic printing. Check of the RS232, USB, Memory card interfaces. General measurement settings and definition of the filters and coefficients for the calculation of the sum vector.
<i>Vibration Analyzer</i>	Setting of the measurement parameters for the screens: VLM_1 (single axis), VLM_2 (vector), PROFILE, STATISTICS e PERCENTILES.

MENU	DESCRIPTION
<i>Spectrum Analyzer</i>	Setting of the measurement parameters of the spectrum.
<i>Data Logger:</i> <ul style="list-style-type: none"> <li>• Profiles</li> <li>• Global</li> </ul>	Setting of the Data Logger mode and makers. Setting of the global measurement parameters (VLM_3 and VLM_4 screens). Auto-Store recording function.
<i>Calibration</i>	Setting of the calibrator acceleration.

## INSTRUMENT

The Instrument menu contains all the data related to the instrument identification, some instrument and interfaces management parameters, the input and output settings and the global acquisition parameters. It is composed by four submenus that are described below:

### Identification

It contains the information that identifies the instrument and the accelerometers.

- **Instrument:** instrument model.
- **Serial number:** instrument serial number.
- **Version:** firmware version currently installed in the instrument.
- **RIGHT configuration:** number of the selected configuration for the RIGHT input. There are 9 configurations available. The parameter can be selected from 0 (deactivated channel) to 9.
- **LEFT configuration:** number of the selected configuration for the LEFT input. There are 9 configurations available. The parameter can be selected from 0 (deactivated channel) to 9.
- **RIGHT Channel:** it indicates OFF when the channel is deactivated, ON TRI when the input is connected to a triaxial accelerometer, ON MON when the input is connected to a monoaxial accelerator.
- **Manufacturer:** manufacturer of the accelerometer connected to the RIGHT input.
- **Model:** model of the accelerometer connected to the RIGHT input.
- **Serial Number:** serial number of the accelerometer connected to the RIGHT input.
- **Sensitivity:** nominal sensitivity (in mV/g) of the accelerometer connected to the RIGHT input.
- **LEFT Channel:** it indicates OFF when the channel is deactivated or ON MON when the input is connected to a monoaxial accelerator.
- **Manufacturer:** manufacturer of the accelerometer connected to the LEFT input.
- **Model:** model of the accelerometer connected to the LEFT input.
- **Serial Number:** serial number of the accelerometer connected to the LEFT input.
- **Sensitivity:** nominal sensitivity (in mV/g) of the accelerometer connected to the LEFT input.
- **Memory Size:** Size of the Memory Flash in the instrument. The standard size is 8Mbyte.
- **Options:** it indicates the installation of firmware options, if any.

### System

It allows to set some system parameters.

- **Hour:** current hour.
- **Date:** current date in the format year/month/day.
- **Vpol ch1:** it indicates the polarization voltage of the accelerometer connected to the RIGHT input channel n.1. The STOP indication, if displayed, indicates that the instrument is in stop mode or that the input is not connected to a sensor.
- **Vpol ch2:** it indicates the polarization voltage of the accelerometer connected to the RIGHT input channel n.2. The STOP indication, if displayed, indicates that the instrument is in stop mode or that the input is not connected to a sensor.
- **Vpol ch3:** it indicates the polarization voltage of the accelerometer connected to the RIGHT input channel n.3. The STOP indication, if displayed, indicates that the instrument is in stop mode or that the input is not connected to a sensor.
- **Vpol ch4:** it indicates the polarization voltage of the accelerometer connected to the LEFT input. The STOP indication, if displayed, indicates that the instrument is in stop mode or that the input is not connected to a sensor.
- **Battery:** it indicates the battery type installed in the instrument. It is possible to choose between ALKALINE (alkaline batteries) or NiMH (rechargeable Nickel-metal hydride batteries).
- **Display Lighting:** it indicates the activation of the of the display backlight. The backlight can also be activated or deactivated through the keyboard, holding pressed the CURSOR key while one of the VLM screens is visualized.
- **Display Contrast:** it allows to adjust the display contrast. When the ambient temperature changes, the display contrast has a small variation: it can be compensated inserting a higher value in order to increase the contrast or a smaller value to decrease it. The value can be set from 3 (minimum) to 9 (maximum).
- **Auto-Switching Off:** the instrument has a function to switch itself off automatically after 5 minutes if the instrument is in STOP mode and no keys are pressed in this time interval. Before switching itself off, the instrument emits a series of warning beeps: press a key to avoid the switching off of the instrument.
- **Language:** it allows to choose the instrument's menu language between Italian, English, French and Spanish.

## Input/Output

Submenu for the choice of the parameters related to the inputs and outputs of the instrument.

- **Type of print:** it activates the printing of the measured levels and it allows to choose which data to print. When the parameter is set to **OFF**, the printing is disabled. In the other cases data are automatically printed when the measurement ends. The possible settings are: **OFF** indicates printing disabled, **VLM** for printing the numerical parameters visualized in the VLM screen, **SPC** for the printing of the octave or third-octave bands levels and **VLM+SPC** for printing both. See the chapter "CONNECTION TO A PRINTER".
- **TRGOUT Source:** the TRGOUT output, if activated with TRGOUT=RUN, switches from the pause level to the active level when the instrument enters the acquisition mode (RUN). When the parameter is set to OFF, the TRGOUT output is deactivated.
- **TRGOUT Polarity:** the TRGOUT output can have a positive (POS) or negative (NEG) polarity, with low or high pause level respectively.
- **RS232 Baud Rate:** this parameter allows to select the data transfer speed for the RS232serial connection from a minimum of 300 to a maximum of 115200 baud. A higher value indicates a faster communication, so, **if there are no other contrary indications**, select the higher possible value to speed up the data transfer. If the instrument is connected to a printer with RS232 serial input or with serial/parallel converter, the value supplied by the printer manufacturer must be set.

**WARNING: when the serial interface is used, the communication between the instrument and the PC (or device with serial input) works only if the Baud Rate**

of the instrument and PC (or device) is the same. The supplied Noise Studio software sets automatically the serial port of the PC: on the instrument set "RS232 Baud Rate = 115200".

- **Memory:** it allows to select the memory device where the data will be recorded. It is possible to select between the internal memory (INT) or the SD memory card (CARD).
- **Serial Device:** it identifies the device connected to the serial interface. The connection possibilities are:
  - *RS232:* connection to a PC with COM ports or to a printer with RS232 serial interface (for example HD40.1).
  - *USB:* connection to a PC through USB port. The connection to the USB port of a PC requests the installation of the apposite driver included in the Noise Studio CD-ROM.

## Measurements

Under the item *MEASURES* there are the general acquisition parameters.

- **Application:** it is possible to choose the type of measure between the vibrations transmitted to the hand-arm system (**HA**), to the whole body (**WB**) or by buildings (**BV**).
- **Input Gain:** select the appropriate input gain among 0dB, 10dB or 20dB, according to the vibrations level to be measured (see the technical data).
- **Integration Delay:** It allows to start the measurement after a stabilization interval settable from a minimum of 2s to a maximum of 99s.
- **Integration Mode:** the instrument has two different integration modes: single (SING) and multiple (MULT). The **single mode** resets the integrated levels at the beginning of the measurement and integrates in the Tint time set in Menu>>Parameters >> Instrument >> Measurement >> Int. Integration. At the end, the instrument stops automatically the measure.

The **multiple integration mode** divides the measurement time in intervals equal to the Tint integration time set in Menu >> Parameters >> Instrument >> Measurement >> Int. Integration. At the beginning of each interval the integrated parameters are reset automatically. For a description of the modes, see the "MEASUREMENT MODES" chapter.

- **Profile Sampling:** sampling interval in the visualization of the time profile, settable from a minimum of 1s to a maximum of 1 hour.
- **Integration Interval:** in single integration mode, this parameter acts as a timer that stops the display updating (HOLD), settable from a minimum of 1s to a maximum of 99 hours. If set to 0s, the timer is deactivated and the integration can only be stopped manually with the START/STOP key. In the multiple integration mode, this parameter determines the duration of each integration interval from a minimum of 10s to a maximum of 1 hour.
- **Measure unit:** the instrument shows in the VLM screens the acceleration levels with one of the following measure units:  $m/s^2$ ,  $cm/s^2$ ,  $ft/s^2$ ,  $in/s^2$ , g and dB (referred to  $10^{-6} m/s^2$ ). When a measure unit different from dB is selected, the acceleration values in the other screens are visualized in  $m/s^2$ .
- **Pond. CH-1:** filter applied to the acceleration detected in channel 1 of the RIGHT input for the calculation of the vector acceleration.
- **Pond. CH-2:** filter applied to the acceleration detected in channel 2 of the RIGHT input for the calculation of the vector acceleration.
- **Pond. CH-3:** filter applied to the acceleration detected in channel 3 of the RIGHT input for the calculation of the vector acceleration.
- **Pond. CH-4:** filter applied to the acceleration detected in channel 4 of the LEFT input for the calculation of the vector acceleration.
- **Coefficient 1:** coefficient applied to the weighted acceleration related to channel 1 in the calculation of the vector acceleration.

- **Coefficient 2:** coefficient applied to the weighted acceleration related to channel 2 in the calculation of the vector acceleration.
- **Coefficient 3:** coefficient applied to the weighted acceleration related to channel 3 in the calculation of the vector acceleration.
- **High-Pass:** high-pass filter that cuts the frequencies lower than 0.6 Hz. It can be useful to decrease the settling time of the accelerometers signal and to improve the response to vibrations with frequent pulses.
- **Ch1-4 0=OFF 1=ON:** the function allows to disable one or more measurement channels that, for example, are not used. The status of each channel is described by a number: 0 (zero) indicates disabled channel, 1 enabled channel. The four channels are indicated in the sequence CH1, CH2, CH3, CH4: to have them all active, the menu item must be Ch1-4=1111. To disable for example the channel CH1, the menu item must be Ch1-4=0111. **It is not allowed to disable all the channels at the same time.**

## VIBRATION ANALYSER

Vibration Analyser Menu contains all the parameters related to the VLM\_1, VLM\_2 and PROFILE screens.

These items can be modified directly in the correspondent screens as described in "DESCRIPTION OF DISPLAY MODES" chapter.

- **Par. Axis. 1 ÷ Par. Axis. 3:** measurement parameters visualized in the VLM\_1 screen in relation with the measure of the acceleration values for a single axis.
- **Par. Vect. 1 ÷ Par. Vect. 3:** measurement parameters visualized in the VLM\_1 screen in relation with the measure of the vector acceleration values.
- **Profile:** measurement parameter visualized in the PROFILE screen.

## SPECTRUM ANALYZER

The Spectrum Analyzer menu contains the parameters related to the spectrum calculation and visualization modes. These items, excluded the parameter *Order*, can be modify directly in the Spectrum screen.

- **Auxiliary Pond:** the frequency weighting of the wide band channel associated with the spectrum and visualized with a vertical bar placed on the right of the display. The pondered level is calculated weighting, according to the selected filter, the octave or third-octave bands levels.
- **Mode:** the updating mode of the octave or third-octave bands spectrum. It can be Multi-Spectra (MULTISP), maximum (MAXIMUM), minimum (MINIMUM) or Integrated (AVERAGE). The multi-spectral mode provides a spectrum per second while the AVERAGE, MAXIMUM and MINIMUM modes respectively visualize the average, maximum and minimum spectrum integrated in the measurement time.
- **Order:** it allows to choice the order of the visualized spectrum: 1/1 for the octave bands spectrum and 1/3 for the third-octave bands spectrum.
- **Spectrum Integration:** this function of frequency integration allows to switch from the visualization of the accelerations spectrum (by selecting OFF that is "no integration") to the velocity spectrum (X1: single integration) or displacements (X2: double integration). The same setting can be obtained directly in measure mode through the arrow keys of the keypad.

## DATA LOGGER

In the recording menu are contained the parameters related to the storage of the measured data. It is composed by the two submenus **Profiles** and **Global** that are described below.

## Profiles

It contains the markers and the profile recordings settings.

- **Mark1 ... Mark9:** represent the available markers. During the recording it is possible to insert the markers to signal interesting events for the current measurement (for the details see the chapter ("RECORDING MODES"))

To assign a name to a marker:

- Use the UP and DOWN arrows to select one of the nine markers and confirm with ENTER.
- The first character of the marker is selected and it can be modified by pressing the UP and DOWN arrows.
- Press the right arrow to move to the second character, use the UP and DOWN arrows to modify the character.
- Repeat the previous two steps for all the characters that form the marker name.
- at the end press MENU to exit from the name editing mode.

Note: the markers can also be set by using the Noise Studio software.

- **Mode:** they are the two recording modes available *Profile* and *Full*.  
"Profile" allows to memorize the profile of a measurement parameter (PROFILE screen), with the sampling interval set in "Menu >> Parameters >> Instrument >> Measurement >> Profile step" from 1s to 1 hour.  
The second recording mode "Full", when the integration mode is single (Menu >> Parameters >> Instrument >> Measurement >> Integration Mode) allows the recording of the profiles of the parameters visualized in the VLM\_1 and VLM\_2 screens and the spectra every second. When the multiple integration mode is active, it is also recorded the statistical analysis together with the VLM\_1 and VLM\_2 parameters and the spectra. The recording interval is programmable from 10s to 1 hour (Menu >> Parameters >> Instrument >> Measure >> Integration Interval).

**ADC Channels:** it sets the direct recording of samples (row signals) supplied by the AD converters. Through the UP and DOWN arrows it is possible to choose to record all the four channels (1234), only one at choice (1---, -2--, ...) or the first three of the RIGHT input (123-). When "ADC Channels" is set on "OFF", the ADC samples are not stored.

Note 1: it is not possible to select an ADC channel if the corresponding measuring channel CH is disabled: enable the measuring channels selecting MENU >> Parameters >> Instrument >> Measurement >> Ch1-4.

Note 2: **storage of the ADC samples is possible only in the Memory card.**

## Global

It contains the settings related to the recording of the global measurement parameters.

- **Par. Axis. 1 ... Par. Sing. 3:** global parameters visualized in the VLM\_3 screen related to the measurement of the acceleration levels for a single axis.
- **Par. Vect. 1 ... Par. Vect. 3:** global parameters visualized in the VLM\_4 screen related to the measure of the vector acceleration levels.
- **Auto-Store:** it activates the automatic storage of global levels at the end of the measurement (for the details see the chapter "RECORDING MODES").

## CALIBRATION

- **Level:** the acceleration value produced by the device used for the calibration of the measurement chain. The acceptable values vary from 0.90m/s<sup>2</sup> to 110.00m/s<sup>2</sup> with a resolution of 0.01m/s<sup>2</sup>.

## **FIRMWARE UPDATE**

The firmware, the program that handles all the analyzer functions, can be updated transferring the file from a PC to the HD2030 through the serial port. In this way it is possible to update the instrument functionality. The updating files are available at the authorized dealers.

To proceed with the update, it is necessary to have installed in the PC the Noise Studio software.

Refer to the on line manual of the software for the operation details.

## REPORTING OF LOW BATTERIES AND REPLACEMENT OF THE BATTERIES

The battery symbol  placed in the upper right corner of the display constantly indicates the charge status of the batteries of the analyzer. As the batteries run down, the symbol is gradually "emptied"...



... when the battery voltage reaches the minimum value to operate correctly, the symbol blinks. In this condition change the batteries as soon as possible.

**Continuing to use the instrument, the battery voltage drops further, and the analyzer is no longer capable of providing a proper measure; any data recording is automatically stopped, finally the acquisition is also stopped and the instrument enters the STOP mode.**

**Below a certain level the instrument turns itself off automatically. The stored data remain. Below a certain level of batteries charge it will not be possible to turn on the instrument.**

The charge level of the batteries is available in the main screen of the menu, expressed as a percentage value. The item is accessed pressing the MENU key. When the level is 0%, it is necessary to replace the batteries.

The battery symbol is replaced by a mains plug when the external power supply is connected.

**Note:** the battery symbol blinks also when it is disabled the automatic auto-switch off (Auto Power OFF = OFF).

To replace the batteries, switch off the instrument and unscrew anti-clockwise the two closing screws of the battery compartment cover. After the replacement of the batteries (4 batteries type AA, 1.5 V alkaline or NiMH rechargeable), close the cover screwing the two screws clockwise. Check the date and time after the replacement of the batteries.

If the batteries replacement takes less than two minutes, it should not be necessary to adjust the clock.

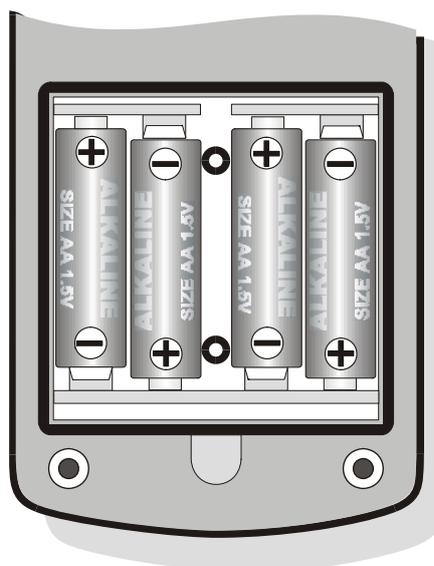

Instead of alkaline batteries, it is possible to use rechargeable batteries NiMH type.

To allow the analyzer to properly manage the charge level of the batteries, it must be selected in the menu the type of batteries used (MENU >> Parameters>> Instrument >> System>> Battery = Alkaline or NiMH).

**The external power supply does not charge the batteries:** rechargeable batteries must be charged separately with an external charger.

#### WARNING ON BATTERIES USE

- If the analyzer is not used for a long period of time, remove the batteries.
- If the batteries are discharged, replace them immediately.
- Avoid leakage from the batteries.
- Use watertight and good quality batteries, alkaline or NiMH.
- If the product does not turn on after the change of the batteries:
  - Remove the batteries
  - Wait at least 5 minutes to allow a complete discharge of the vibrations analyzer internal circuit
  - Insert the missing battery: with charged batteries, the instrument should switch itself on automatically.

## INSTRUMENT STORAGE

Storage conditions of the instrument:

- Temperature: -25 ... 70 ° C.
- Humidity: less than 90% R.H. not condensing.
- In the storage avoid places where:
  - The humidity is high.
  - The instrument is exposed to direct radiation of the sun.
  - The instrument is exposed to a source of high temperature.
  - There are strong vibrations.
  - There are steam, salt and/or corrosive gas.

The casing of the instrument is made of ABS plastic material and the protective band is made of rubber: do not use solvents to clean them.

## SERIAL INTERFACE

The instrument has a dual serial interface:RS232C and USB.

The RS232 port has an 8-pole Mini-Din connector and it can be connected to any COM port of a PC or to a printer (e.g. the HD40.1) using the proper connection cable HD2110CSNM.

The USB port allows the connection to a USB port of a PC through the supplied cable CP22 type A/B.

The interface selection is done through the menu item "MENU>> Parameters >> Instrument >> Input/Output >> Serial Dev.:

- **RS232:** connection through RS232 interface to a PC provided with a COM type port. For the connection it can be supplied on request the **HD2110CSNM** cable, *null-modem* type with female 9-pole subD connector. This cable is also usable for the connection to the HD40.1 portable printer.
- **USB:** connection through USB interface to a PC that has installed the appropriate driver VCOM. The drivers are included in the CD-ROM of the Noise Studio software. For the connection is supplied the cable **CP22**.

Unlike the RS232 connection that requires no special programs for its operation, the USB connection requires the prior installation in the PC of a special program (driver USB) provided in the CD that is supplied with the instrument.

In the MiniDin female 8-pole connector of the **instrument** there are the following signals:

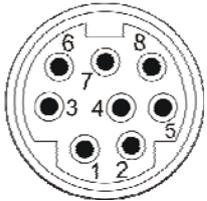
	Pin	Direction	Signal	Description
<b>External view</b>	1	Output	VDD	3.3V power supply
	2	Output	DTE	DTE ready
	3	Input	DCE - CD	DCE ready – Carrier detect
	4	Output	RTS	Request to send
	5	Output	TD	Channel data reception
	6	Input	RD	Channel data transmission
	7	-	GND	Reference ground
	8	Input	CTS	Clear to send

In the subD female 9-pole connector of the **HD2110CSNM** cable, there are the following signals:

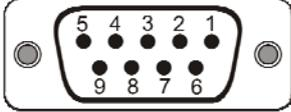
	Pin	Direction	Signal	Description
<b>External view</b>	1	DCE >> HD2030	DCE - CD	DCE ready – Carrier detect
	2	DCE >> HD2030	RD	Channel data reception
	3	HD2030>> DCE	TD	Channel data transmission
	4	HD2030>> DCE	DTE	DTE ready
	5	-	GND	Reference ground
	7	HD2030>> DCE	RTS	Request to send
	8	DCE >> HD2030	CTS	Clear to send
	9	HD2030>> DCE	VDD	3.3V power supply

**When the instrument is connected via a serial interface to an active terminal (DCE active, for example a PC), the auto-switch off is disabled and it is not possible to switch off the instrument.**

**If the analyzer is turned off, the connection to an active terminal (DCE active) will lead to the automatic switch on.**

The standard serial transmission parameters of the instrument are:

- Baud rate    115200 baud
- Parity        None
- N. bit        8
- Stop bit      1
- Protocol     Hardware.

It is possible to change the speed of the data transmission through the item "baudrate" in the menu (MENU >> Parameters >> Instrument >> Input/Output >> baudrate).

The available baud rates are: 115200, 57600, 38400, 19200, 9600, 4800, 2400, 1200, 600, 300. The other transmission parameters cannot be altered.

To enable the full control of the instrument through a PC, the HD2030 is equipped with a communication protocol with a complete set of commands described in detail in the appendix.

## MEASURE PARAMETERS

The parameters that can be displayed in the VLM and PROFILE screens are selectable among the ones of the following lists:

*VLM\_1 screen: Single axis parameters.*

### Parameter Description

- Pk** instant peak value of the frequency weighted acceleration.
- Pkmax** Max peak value of the frequency weighted acceleration.
- AeqS** Time average (linear) of the frequency weighted acceleration calculated in the last second ("running r.m.s."):

$$A_{eqS}(t) = \left( \int_{t-1s}^t a_w^2(\xi) d\xi \right)^{1/2}$$

Where:

$a_w(\xi)$  is the frequency weighted single axis instant acceleration.

- Aeq** Time average (linear) of the frequency weighted acceleration, calculated in the measurement time:

$$A_{eq} = \left( \frac{1}{T} \int_0^T a_w^2(\xi) d\xi \right)^{1/2}$$

where:

$a_w(\xi)$  is the frequency weighted single axis instant acceleration

T is the measurement time.

- A1s** Time average (exponential) of the frequency weighted acceleration with time constant of 1 second:

$$A_{1s}(t) = \left( \frac{1}{\tau} \int_{-\infty}^t a_w^2(\xi) \exp\left(\frac{\xi-t}{\tau}\right) d\xi \right)^{1/2}$$

Where:

$a_w(\xi)$  is the frequency weighted single axis instant acceleration

$\tau = 1s$  is the time constant of the exponential function.

- A8s** Time average (exponential) of the frequency weighted acceleration with a time constant of 8 seconds.

- A1smx** Maximum value of the timed average (exponential) of the frequency weighted acceleration with time constant of 1 second.

- A8smx** Maximum value of the timed average (exponential) of the frequency weighted acceleration with time constant of 8 seconds.

- A1smn** Minimum value of the timed average (exponential) of the frequency weighted acceleration with time constant of 1 second.

- A8smn** Minimum value of the timed average (exponential) of the frequency weighted acceleration with time constant of 8 seconds.

- A(1s)** Equivalent value of the frequency weighted acceleration in the measurement time referenced to 1 second:

$$A(1s) = \left( \frac{1}{T_0} \int_0^T a_w^2(\xi) d\xi \right)^{1/2}$$

where:

$a_w(\xi)$  is the frequency weighted single axis instant acceleration

T is the measurement time.

A(8) Equivalent value of the frequency weighted acceleration in the measurement time referenced to 8 hours:

$$A(8) = \left( \frac{1}{T_{8h}} \int_0^T a_w^2(\xi) d\xi \right)^{1/2}$$

where:

$a_w(\xi)$  is the frequency weighted single axis instant acceleration

$T_{8h} = 28800$  is the number of seconds in 8 hours.

VDV Vibrations Dose Value in the measurement time:

$$VDV = \left( \int_0^T a_w^4(\xi) d\xi \right)^{1/4}$$

where:

$a_w(\xi)$  is the frequency weighted single axis instant acceleration.

VDV,d Daily evaluation (8 hours) of the vibrations dose:

$$VDV,d = \left( \frac{T}{T_{8h}} \int_0^T a_w^4(\xi) d\xi \right)^{1/4}$$

where:

$a_w(\xi)$  is the frequency weighted single axis instant acceleration

T is the measurement time

$T_{8h} = 28800$  is the number of seconds in 8 hours.

MTVV Maximum value of the time average (linear) of the frequency weighted acceleration calculated in the last second.

CFeq Crest factor calculated as ratio between the maximum peak value and the time average of the frequency weighted acceleration:

$$CF_{eq} = \frac{Pk_{mx}}{\left( \frac{1}{T} \int_0^T a_w^2(\xi) d\xi \right)^{1/2}}$$

where:

$a_w(\xi)$  is the frequency weighted single axis instant acceleration

T is the measurement time.

CF Crest factor calculated as ratio between the instant peak value and the time average of the frequency weighted acceleration in the last second:

$$CF(t) = \frac{Pk(t)}{\left( \int_{t-1s}^t a_w^2(\xi) d\xi \right)^{1/2}}$$

where:

$a_w(\xi)$  is the frequency weighted single axis instant acceleration.

CFmx Maximum value of the Crest factor CF calculated as ratio between the instant peak value and the time average of the frequency weighted acceleration in the last second.

VDVr Ratio between the vibrations dose value (VDV) and the time average (linear) of the frequency weighted acceleration in the measurement time:

$$VDV_r = \frac{VDV}{\left( \frac{1}{T} \int_0^T a_w^2(\xi) d\xi \right)^{1/2}}$$

where:

$a_w(\xi)$  is the frequency weighted single axis instant acceleration

T is the measurement time.

MTVV<sub>r</sub> Ratio between the maximum value calculated in the last second (MTVV) and the time average (linear) of the frequency weighted acceleration calculated in the measurement time:

$$MTVV_r = \frac{MTVV}{\left(\frac{1}{T} \int_0^T a_w^2(\xi) d\xi\right)^{1/2}}$$

where:

$a_w(\xi)$  is the frequency weighted single axis instant acceleration  
T is the measurement time.

OL Percentage of time with "overload".

UR Percentage of time with "under-range"

*VLM\_2 screen: Parameters referred to the acceleration vector.*

### Parameter Description

Pk Instant peak value of the frequency weighted acceleration:

$$Pk(t) = \sqrt{c_1^2 Pk_1^2(t) + c_2^2 Pk_2^2(t) + c_3^2 Pk_3^2(t)}$$

where:

$Pk_{1,2,3}(t)$  are the instant peak values of the frequency weighted acceleration in each axis

$c_{1,2,3}$  are multiplying coefficients dependent on the specific application.

Pk<sub>mx</sub> Maximum peak value of the frequency weighted acceleration.

Aeq<sub>S</sub> Time average (linear) of the frequency weighted acceleration calculated in the last second ("running r.m.s."):

$$A_{eqS}(t) = \left( \int_{t-1s}^t (c_1^2 a_{1,w}^2(\xi) + c_2^2 a_{2,w}^2(\xi) + c_3^2 a_{3,w}^2(\xi)) d\xi \right)^{1/2}$$

where:

$a_{1,2,3,w}(\xi)$  are the instant frequency weighted accelerations in each axis

$c_{1,2,3}$  are multiplying coefficients dependent on the specific application.

Aeq Time average (linear) of the frequency weighted acceleration, calculated in the measurement time:

$$A_{eq} = \left( \frac{1}{T} \int_0^T (c_1^2 a_{1,w}^2(\xi) + c_2^2 a_{2,w}^2(\xi) + c_3^2 a_{3,w}^2(\xi)) d\xi \right)^{1/2}$$

where:

$a_{1,2,3,w}(\xi)$  are the instant frequency weighted accelerations in each axis

$c_{1,2,3}$  are multiplying coefficients dependent on the specific application

T is the measurement time.

A1s Time average (exponential) of the frequency weighted acceleration with time constant of 1 second:

$$A_{1s}(t) = \left( \frac{1}{\tau} \int_{-\infty}^t (c_1^2 a_{1,w}^2(\xi) + c_2^2 a_{2,w}^2(\xi) + c_3^2 a_{3,w}^2(\xi)) \exp\left(\frac{\xi-t}{\tau}\right) d\xi \right)^{1/2}$$

where:

$a_{1,2,3,w}(\xi)$  are the instant frequency weighted accelerations in each axis

$c_{1,2,3}$  are multiplying coefficients dependent on the specific application

$\tau = 1s$  is the time constant of the exponential equation.

A8s Time average (exponential) of the frequency weighted acceleration with a time constant of 8 seconds.

- A1smx Maximum value of the time average (exponential) of the frequency weighted acceleration with time constant of 1 second.
- A8smx Maximum value of the time average (exponential) of the frequency weighted acceleration with time constant of 8 seconds.
- A1smn Minimum value of the time average (exponential) of the frequency weighted acceleration with time constant of 1 second.
- A8smn Minimum value of the time average (exponential) of the frequency weighted acceleration with time constant of 8 seconds.
- A(1s) Equivalent value of the frequency weighted acceleration in the measurement time referenced to 1 second:

$$A(1s) = \left( \frac{1}{T_0} \int_0^T (c_1^2 a_{1,w}^2(\xi) + c_2^2 a_{2,w}^2(\xi) + c_3^2 a_{3,w}^2(\xi)) d\xi \right)^{1/2}$$

where:

$a_{1,2,3,w}(\xi)$  are the instant frequency weighted accelerations in each axis  
 $c_{1,2,3}$  are multiplying coefficients dependent on the specific application  
 $T$  is the measurement time.

- A(8) Equivalent value of the frequency weighted acceleration in the measurement time referenced to 8 hours:

$$A(8) = \left( \frac{1}{T_{8h}} \int_0^T (c_1^2 a_{1,w}^2(\xi) + c_2^2 a_{2,w}^2(\xi) + c_3^2 a_{3,w}^2(\xi)) d\xi \right)^{1/2}$$

where:

$a_{1,2,3,w}(\xi)$  are the instant frequency weighted accelerations in each axis  
 $c_{1,2,3}$  are multiplying coefficients dependent on the specific application  
 $T_{8h} = 28800$  is the number of seconds in 8 hours.

- MTVV Maximum value of the time average (linear) of the frequency weighted acceleration calculated in the last second.
- CFeq Crest factor calculated as ratio between the maximum peak value and the time average of the frequency weighted acceleration:

$$CF_{eq} = \frac{Pk_{mx}}{\left( \frac{1}{T} \int_0^T (c_1^2 a_{1,w}^2(\xi) + c_2^2 a_{2,w}^2(\xi) + c_3^2 a_{3,w}^2(\xi)) d\xi \right)^{1/2}}$$

where:

$Pk_{mx}$  is the maximum peak value of the frequency weighted acceleration vector  
 $a_{1,2,3,w}(\xi)$  are the instant frequency weighted accelerations in each axis  
 $c_{1,2,3}$  are multiplying coefficients dependent on the specific application  
 $T$  is the measurement time.

- CF Crest factor calculated as ratio between the instant peak value and the time average of the frequency weighted acceleration in the last second:

$$CF(t) = \frac{Pk(t)}{\left( \int_{t-1s}^t (c_1^2 a_{1,w}^2(\xi) + c_2^2 a_{2,w}^2(\xi) + c_3^2 a_{3,w}^2(\xi)) d\xi \right)^{1/2}}$$

where:

$Pk$  is the instant peak value of the frequency weighted acceleration vector  
 $a_{1,2,3,w}(\xi)$  are the instant frequency weighted acceleration in each axis  
 $c_{1,2,3}$  are multiplying coefficients dependent on the specific application.

- CFmx Maximum value of the Crest factor CF calculated as ratio between the instant peak value and the time average of the frequency weighted acceleration in the last second.

MTVV<sub>r</sub> Ratio between the maximum value calculated in the last second (MTVV) and the time average (linear) of the frequency weighted acceleration calculated in the measurement time:

$$MTVV_r = \frac{MTVV}{\left( \frac{1}{T} \int_0^T (c_1^2 a_{1,w}^2(\xi) + c_2^2 a_{2,w}^2(\xi) + c_3^2 a_{3,w}^2(\xi)) d\xi \right)^{1/2}}$$

where:

$a_{1,2,3,w}(\xi)$  are the instant frequency weighted accelerations in each axis  
 $c_{1,2,3}$  are multiplying coefficients dependent on the specific application  
 T is the measurement time.

### VLM\_3 Screen: Single axis global parameters.

#### Parameter Description

Pk<sub>mx</sub> Maximum peak value of the frequency weighted acceleration.

A<sub>eq</sub> Time average (linear) of the frequency weighted acceleration calculated in the measurement time:

$$A_{eq} = \left( \frac{1}{T} \int_0^T a_w^2(\xi) d\xi \right)^{1/2}$$

where:

$a_w(\xi)$  is the single axis frequency weighted instant acceleration  
 T is the measurement time.

A1<sub>smx</sub> Maximum value of the time average (exponential) of the frequency weighted acceleration with time constant of 1 second.

A8<sub>smx</sub> Maximum value of the time average (exponential) of the frequency weighted acceleration with time constant of 8 seconds.

A1<sub>smn</sub> Minimum value of the time average (exponential) of the frequency weighted acceleration with time constant of 1 second.

A8<sub>smn</sub> Minimum value of the time average (exponential) of the frequency weighted acceleration with time constant of 8 seconds.

A(1s) Equivalent value of the frequency weighted acceleration in the measurement time referenced to 1 second:

$$A(1s) = \left( \frac{1}{T} \int_0^T a_w^2(\xi) d\xi \right)^{1/2}$$

where:

$a_w(\xi)$  is the frequency weighted single axis instant acceleration  
 T is the measurement time.

A(8) Equivalent value of the frequency weighted acceleration in the measurement time referenced to 8 hours.

$$A(8) = \left( \frac{1}{T_{8h}} \int_0^T a_w^2(\xi) d\xi \right)^{1/2}$$

where:

$a_w(\xi)$  is the frequency weighted single axis instant acceleration  
 $T_{8h} = 28800$  is the number of seconds in 8 hours.

VDV Vibrations Dose Value in the measurement time:

$$VDV = \left( \int_0^T a_w^4(\xi) d\xi \right)^{1/4}$$

where:

$a_w(\xi)$  is the frequency weighted single axis instant acceleration.

VDV,d Daily evaluation (8 hours) of the vibrations dose:

$$VDV,d = \left( \frac{T}{T_{8h}} \int_0^T a_w^4(\xi) d\xi \right)^{1/4}$$

where:

$a_w(\xi)$  is the frequency weighted single axis instant acceleration  
T is the measurement time.

$T_{8h} = 28800$  is the number of seconds in 8 hours.

MTVV Maximum value of the time average (linear) of the frequency weighted acceleration calculated in the last second.

CFeq Crest factor calculated as ratio between the maximum peak value and the time average of the frequency weighted acceleration:

$$CF_{eq} = \frac{Pk_{mx}}{\left( \frac{1}{T} \int_0^T a_w^2(\xi) d\xi \right)^{1/2}}$$

where:

$a_w(\xi)$  is the frequency weighted single axis instant acceleration  
T is the measurement time.

CF Crest factor calculated as ratio between the instant peak value and the time average of the frequency weighted acceleration in the last second:

$$CF(t) = \frac{Pk(t)}{\left( \int_{t-1s}^t a_w^2(\xi) d\xi \right)^{1/2}}$$

where:

$a_w(\xi)$  is the frequency weighted single axis instant acceleration.

CFmx Maximum value of the Crest factor CF calculated as ratio between the instant peak value and the time average of the frequency weighted acceleration in the last second.

VDVr Ratio between the vibrations dose value (VDV) and the time average (linear) of the frequency weighted acceleration in the measurement time:

$$VDV_r = \frac{VDV}{\left( \frac{1}{T} \int_0^T a_w^2(\xi) d\xi \right)^{1/2}}$$

where:

$a_w(\xi)$  is the frequency weighted single axis instant acceleration  
T is the measurement time.

MTVvr Ratio between the maximum value calculated in the last second (MTVV) and the time average (linear) of the frequency weighted acceleration calculated in the measurement time:

$$MTVv_r = \frac{MTVV}{\left( \frac{1}{T} \int_0^T a_w^2(\xi) d\xi \right)^{1/2}}$$

where:

$a_w(\xi)$  is the frequency weighted single axis instant acceleration  
T is the measurement time.

OL Percentage of time with "overload".

UR Percentage of time with "under-range".

*VLM\_4 Screen: Acceleration vector global parameters.*

**Parameter Description**

**Pk<sub>mx</sub>** Maximum value of the frequency weighted acceleration.

**A<sub>eq</sub>** Time average (linear) of the frequency weighted acceleration calculated in the measurement time:

$$A_{eq} = \left( \frac{1}{T} \int_0^T (c_1^2 a_{1,w}^2(\xi) + c_2^2 a_{2,w}^2(\xi) + c_3^2 a_{3,w}^2(\xi)) d\xi \right)^{1/2}$$

where:

$a_{1,2,3,w}(\xi)$  are the instant frequency weighted accelerations in each axis  
 $c_{1,2,3}$  are multiplying coefficients dependent on the specific application  
 T is the measurement time.

**A1smx** Maximum value of the time average (exponential) of the frequency weighted acceleration with time constant of 1 second.

**A8smx** Maximum value of the time average (exponential) of the frequency weighted acceleration with time constant of 8 seconds.

**A1smn** Minimum value of the time average (exponential) of the frequency weighted acceleration with time constant of 1 second.

**A8smn** Minimum value of the time average (exponential) of the frequency weighted acceleration with time constant of 8 seconds.

**A(1s)** Equivalent value of the frequency weighted acceleration in the measurement time referenced to 1 second:

$$A(1s) = \left( \frac{1}{T_0} \int_0^T (c_1^2 a_{1,w}^2(\xi) + c_2^2 a_{2,w}^2(\xi) + c_3^2 a_{3,w}^2(\xi)) d\xi \right)^{1/2}$$

where:

$a_{1,2,3,w}(\xi)$  are the instant frequency weighted accelerations in each axis  
 $c_{1,2,3}$  are multiplying coefficients dependent on the specific application  
 T is the measurement time.

**A(8)** Equivalent value of the frequency weighted acceleration in the measurement time referenced to 8 hours:

$$A(8) = \left( \frac{1}{T_{8h}} \int_0^T (c_1^2 a_{1,w}^2(\xi) + c_2^2 a_{2,w}^2(\xi) + c_3^2 a_{3,w}^2(\xi)) d\xi \right)^{1/2}$$

where:

$a_{1,2,3,w}(\xi)$  are the instant frequency weighted accelerations in each axis  
 $c_{1,2,3}$  are multiplying coefficients  
 $T_{8h} = 28800$  is the number of seconds in 8 hours.

**MTVV** Maximum value of the time average (linear) of the frequency weighted acceleration calculated in the last second.

**CF<sub>eq</sub>** Crest factor calculated as ratio between the maximum peak value and the time average of the frequency weighted acceleration:

$$CF_{eq} = \frac{Pk_{mx}}{\left( \frac{1}{T} \int_0^T (c_1^2 a_{1,w}^2(\xi) + c_2^2 a_{2,w}^2(\xi) + c_3^2 a_{3,w}^2(\xi)) d\xi \right)^{1/2}}$$

where:

$Pk_{mx}$  is the maximum peak value of the frequency weighted acceleration vector  
 $a_{1,2,3,w}(\xi)$  are the instant frequency weighted accelerations in each axis  
 $c_{1,2,3}$  are multiplying coefficients dependent on the specific application  
 T is the measurement time.

CFmx Maximum value of the Crest factor CF calculated as ratio between the instant peak value and the time average of the frequency weighted acceleration in the last second.

MTVVr Ratio between the maximum value calculated in the last second (MTVV) and the time average (linear) of the frequency weighted acceleration calculated in the measurement time:

$$MTVV_r = \frac{MTVV}{\left( \frac{1}{T} \int_0^T (c_1^2 a_{1,w}^2(\xi) + c_2^2 a_{2,w}^2(\xi) + c_3^2 a_{3,w}^2(\xi)) d\xi \right)^{1/2}}$$

where:

$a_{1,2,3,w}(\xi)$  are the instant frequency weighted accelerations in each axis

$c_{1,2,3}$  are multiplying coefficients dependent on the specific application

T is the measurement time.

*PROFILE Screen page (only single axis parameters):*

**Parameter Description**

Pkmx Maximum peak value of the frequency weighted acceleration.

Aeq Time average (linear) of the frequency weighted acceleration calculated in the measurement time:

$$A_{eq} = \left( \frac{1}{T} \int_0^T a_w^2(\xi) d\xi \right)^{1/2}$$

where:

$a_w(\xi)$  is the single axis frequency weighted instant acceleration

T is the measurement time.

A1smx Maximum value of the time average (exponential) of the frequency weighted acceleration with time constant of 1 second.

A8smx Maximum value of the time average (exponential) of the frequency weighted acceleration with time constant of 8 seconds.

A1smn Minimum value of the time average (exponential) of the frequency weighted acceleration with time constant of 1 second.

A8smn Minimum value of the time average (exponential) of the frequency weighted acceleration with time constant of 8 seconds.

The parameter selected in the PROFILE mode is used for the statistical analysis.

The attribute of the parameters that can be displayed in the VLM and PROFILE modes indicates the related frequency weighting.

APPLICATION	FREQUENCY WEIGHS
Hand-Arm (HA)	Fz, Fc, Wh
Whole Body (WB)	Fz, Fa, Wb, Wc, Wd, We, Wj, Wk
Building Vibrations (BV)	Fz, Fm, Wm

Fz: Flat weighting on the entire frequency range

Fa: Band limitation filter for whole body measurements: 0.4Hz ... 100Hz

Fc: Band limitation filter for Hand-Arm system measurements: 6.3Hz ... 1250Hz

Fm: Band limitation filter for vibrations transmitted by buildings measurements: 0.8Hz ... 100Hz

Wb: filter for the measurement of the whole body vertical acceleration (z axis) for standing, sitting or supine people (ISO 2631-4)

Wc: filter for the measurement of the whole body horizontal acceleration (x axis) transmitted from back to sitting people (ISO 2631-1)

- Wd: filter for the measurement of the whole body horizontal acceleration (x or y axis), for standing, sitting or supine people (ISO 2631-1)
- We: filter for the measurement of the whole body angular acceleration (all directions) for sitting people (ISO 2631-1)
- Wh: filter for the measurement of the acceleration transmitted to the hand-arm system (all directions) (ISO 5349-1)
- Wj: filter for the measurement of the head vertical acceleration (x axis) for supine people (ISO 2631-1)
- Wk: filter for the measurement of the whole body vertical acceleration (z axis) for standing, sitting or supine people (ISO 2631-1)
- Wm: filter for the measurement of the buildings transmitted acceleration (all directions) (ISO 2631-2)

Frequency Weighting graphs are shown in appendix on page 128

The acceleration values can be displayed also as acceleration level in decibel using the relation:

$$L_w = 20 \log \frac{a_w}{a_0}$$

where:

$a_w$  is the frequency weighted acceleration

$a_0$  is the reference acceleration equal to  $10^{-6}$  m/s<sup>2</sup> (ISO 1683).

The measurement parameters can be displayed with different units.

MEASURE PARAMETER		MEASURE UNIT	
SYMBOL	DESCRIPTION		
Pk	Instant peak	m/s <sup>2</sup> , cm/s <sup>2</sup> , ft/s <sup>2</sup> , in/s <sup>2</sup> , g, dB	
Pk <sub>mx</sub>	Maximum peak value in the measurement time		
A <sub>eqS</sub>	Average acceleration value calculated every second with linear integration		
A <sub>eq</sub>	Average acceleration value linearly integrated in the measurement time		
A <sub>1s</sub>	Average acceleration value calculated every second with a time constant equal to 1 second		
A <sub>8s</sub>	Average acceleration value calculated every second with a time constant equal to 8 seconds		
A <sub>1smx</sub>	Maximum value of the average acceleration calculated every second with 1s time constant		
A <sub>8smx</sub>	Maximum value of the average acceleration calculated every second with 8s time constant		
A <sub>1smn</sub>	Minimum value of the average acceleration calculated every second with 1s time constant		
A <sub>8smn</sub>	Minimum value of the average acceleration calculated every second with 8s time constant		
A(1s)	Value referenced to 1 second of the acceleration linearly integrated in the measurement time		
A(8)	Value referenced to 8 hours of the acceleration linearly integrated in the measurement time		
MTVV	Maximum value of the average acceleration linearly integrated every second		
VDV	Vibrations dose value linearly integrated in the measurement time		m/s <sup>1.75</sup>
VDV,d	Value referenced to 8 hours of the vibrations dose linearly integrated in the measurement time		

<b>MEASURE PARAMETER</b>		<b>MEASURE UNIT</b>
<b><i>SYMBOL</i></b>	<b><i>DESCRIPTION</i></b>	
CFeq	Crest factor calculated as ratio between the maximum peak and the average of the acceleration. It is calculated in the measurement time	without dimension
CF	Instant crest factor calculated as ratio between peak and average value of the acceleration in 1 second	
CFmx	Maximum instant crest factor value calculated as ratio between peak and average value of the acceleration in 1 second. It is calculated in the measurement time	
VDVr	Ratio between vibrations dose and the average value of the acceleration linearly integrated in the measurement time	
MTVr	Ratio between the maximum value of average acceleration integrated every second and the average acceleration integrated in the measurement time. The acceleration integration is linear.	
OL	Overload time percentage during measurement	%
UR	Under-range time percentage during measurement	

## DIRECT PRINTER CONNECTION

The HD2030 analyzer can print the visualized levels in a format compatible with that of a portable printer with 24 columns like the *HD40.1* printer.

The printer has to be connected to the serial port of the instrument.

**Printer and vibrations analyzer must be properly configured.**

### HD2030 configuration

1. Set the parameter MENU >> Parameters >> Instrument >> Input/Output >> RS232 Baud Rate: 38.4k.
2. Set the parameter MENU >> Parameters >> Instrument >> Input/Output >> Serial Dev.: RS232.



### Printer configuration

1. The communication speed of the printer (Baud Rate) **must be equal** to the one set in the analyzer (38400 baud).  
This is the only parameter requested for the HD40.1 printer.

The other connection parameters for printers different from the HD40.1 are:

2. Data bits: 8.
3. Parity: none.
4. Stop bit: 1.
5. Flow control (Handshaking): Hardware.
6. Automatic paper advance (Autofeed): enable.

Connect the HD2030 to the printer using the **HD2110CSNM** cable.

### To proceed with the data printing:

- Switch on the instrument.
- Enter the MENU >> Parameters >> Instrument >> Input/Output and set the item:
  - **Printout** =
    - **VLM** for printing the numerical parameters visualized in the VLM screen,
    - **SPC** for printing the octave or third-octave bands levels,
    - **VLM+SPC** for printing both.
- Start the measurement: when the instrument enter the stop mode, the data are automatically printed.
- To disable the printing, set the menu item **Printout** = **OFF**.

## CONNECTION TO A PC WITH USB INTERFACE

The HD2030 can be connected to the USB port of a PC using the CP22 cable.

The connection through the USB port requires the installation of a driver supplied with the Noise Studio Software.

**Before connecting the instrument to the USB port of the PC, install the Noise Studio software.**

**With Windows 7 operating systems you need to start your PC by disabling *driver signature*, as explained in the USB drivers installation guide contained in the installation CDROM of Noise Studio software**

*Proceed as follows:*

1. **Set the instrument menu item "MENU >> Parameters >> Instrument >> Input/Output >> Serial Device" to "USB". Confirm and exit from the menu".**
2. **Do not connect the instrument to USB port until requested from the wizard**
3. Insert **Noise Studio** installation CD-ROM and wait for AutoPlay window to appear. In Windows Vista and Windows 7 operating systems it's shown the window below; select "autorun.exe execution" (see "note 1" in the next paragraph)

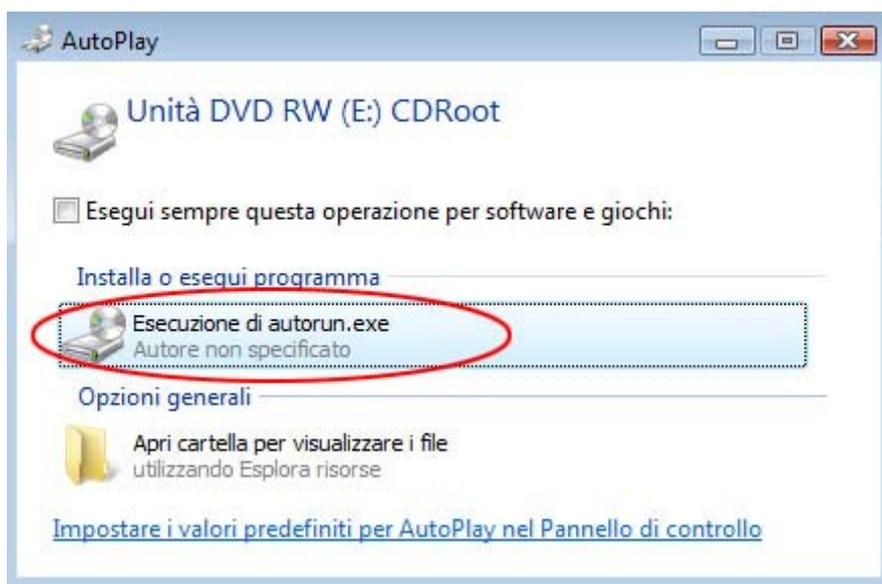

4. The starting screen of Noise Studio will be opened: if the operating system prevents software to start, please see "note 1" in the next paragraph.
5. From starting window of Noise Studio click on "USB drive installation" to start the driver installation procedure.
6. The program checks the Windows® operating system version and copies related drivers in a temporary folder.
7. At the end a message appears asking to plug the vibration meter connection cable to PC USB port: press OK and close **Noise Studio** software pressing EXIT key.
8. **Connect the vibration meter to USB port and turn it ON:** when Windows recognise the instrument, it appears a message " *a new device has been detected*".
9. Wait some seconds until the message "new hardware is installed and ready to work" appears.
10. Driver installation procedure is ended: whenever the instrument will be connected it will be automatically recognized.

## Installation Notes

### Note 1: for Windows Vista and Windows 7 operating systems..

1. For software installation is requested Administrator permission
2. If the operating system prevents the software to open, boot the PC as **administrator user**, insert installation CD-ROM and, when the following window appears, select "open folder to view files"

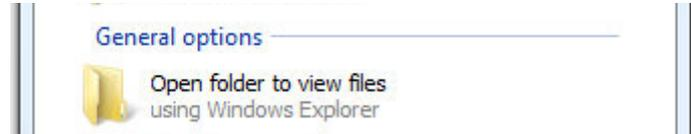

3. In the following screen, click with right mouse key on file "Autorun" and select "Execute as administrator":
4. Continue from point 5 of previous paragraph.

**Note 2:** if the vibration meter has been connected to USB port **before USB driver installation**, in Windows 2000 and XP operating systems it appears the window "new hardware installation". In Windows Vista and Windows 7 it appears an installation error under "device manager": in both cases, cancel operation, disconnect instrument and restart the complete procedure starting from the beginning of this guide.

## Verification of proper driver installation

To verify the proper installation procedure, proceed as follows.

On Windows 2000 and XP operating systems:

Select "START >> Settings >> Control Panel", double click on SYSTEM icon. Select "Hardware >> Device Manager"

On Windows Vista and Windows 7 operating systems:

Select "START >> Control panel", then click on "Device Manager" icon.

Connect instrument to USB port.

The following items should appear:

- "Port (COM and LPT) >> USB Serial Port (COM#)". **The value # is the number assigned to virtual serial port**
- "Controller USB (Universal serial bus) >> USB serial converter"

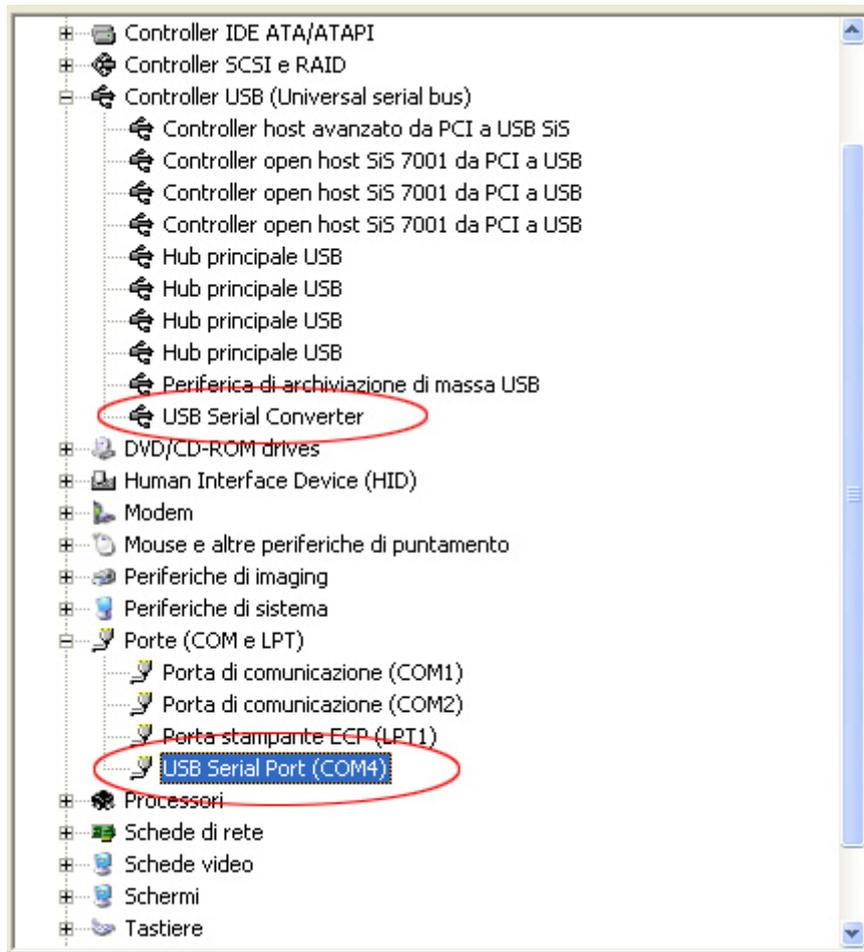

When USB cable is unplugged, the above items will disappear and they will appear again as soon as the instrument is plugged to USB port.

In the documentation supplied with the **Noise Studio** CD-ROM, it's available a detailed version, including pictures, of the USB driver management guide. Procedure to remove USB driver is also reported.

## CONNECTORS DESCRIPTION

### Front panel connectors

The following figure indicates the connectors in the HD2030 front panel.

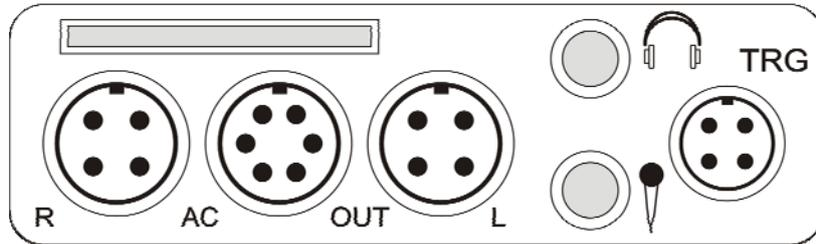

### Right connector

Identified with **R** letter, it is a male connector with 4 poles LEMO-B type for the connection of a triaxial or monoaxial accelerometer with integrated electronics (IEPE type or compatible). The pin numbering is seen from outside.

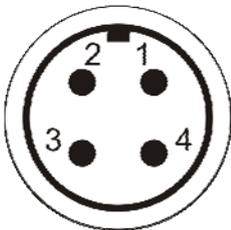

PIN	DESCRIPTION
1	Ground
2	Accelerometer channel #3
3	Accelerometer channel #2
4	Accelerometer channel #1

### LINE connector

Identified with **AC\_OUT** indication, it is a 6 poles connector LEMO-B type for the analog outputs (**LINE**) of the 4 input channels.

The pin numbering is seen from outside

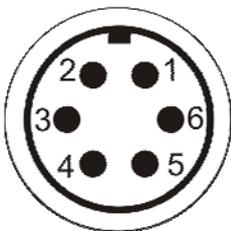

PIN	DESCRIPTION
1	Ground
2	Line Output #1
3	Line Output #2
4	Line Output #3
5	Line Output #4
6	Audio output

### Left connector

Identified with **L** letter, it is a male connector with 4 poles LEMO-B type for the connection of a monoaxial accelerometer with integrated electronics (IEPE type or compatible).

The pin numbering is seen from outside

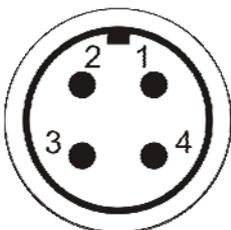

PIN	DESCRIPTION
1	Ground
2	Accelerometer channel #4
3	Not connected
4	Not connected

### Trigger Connector

Male connector with 4 poles LEMO-00 type for the trigger function, it is identified with **TRG** indication. The trigger input is differential type.

The pin numbering is seen from outside.

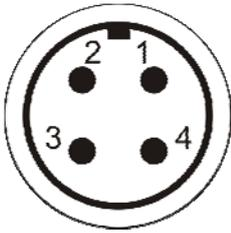

PIN	DESCRIPTION
1	Negative input of trigger
2	Trigger output
3	Ground
4	Positive input of trigger

### Headphones jack

Jack (Ø3.5mm) type output for the connection of the headphones.

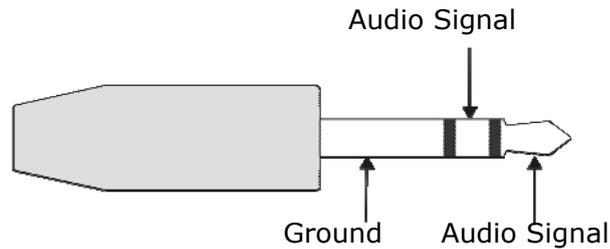

### Microphone jack

Jack (Ø3.5mm) type input pin for the microphone.

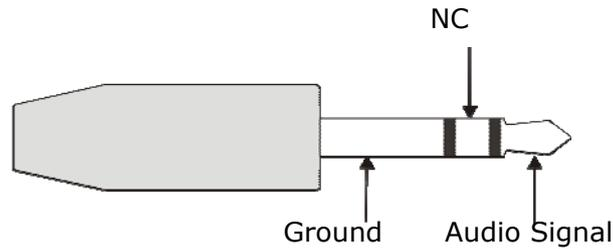

### Bottom panel connectors

Following is the description of the connectors present in the bottom panel of the HD2030.

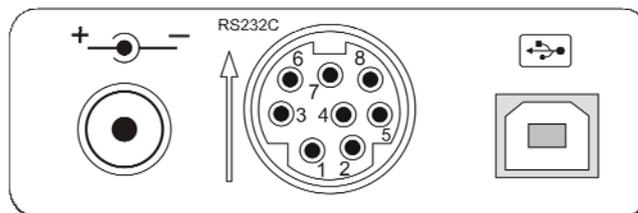

### Power supply connector

Male connector for **external power supply** ( $\varnothing$  5.5mm-2.1mm pin).

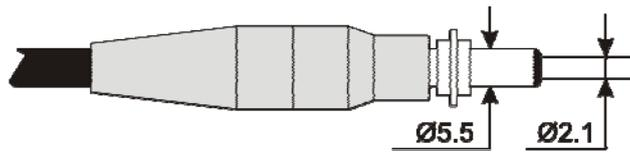

It requires a 9...12Vdc/300mA power supply.

The positive of the power supply is supplied to central pin.



### MiniDin 8 poles connector

**MiniDin** 8 poles connector for RS232C serial port. For the connection use the null-modem dedicated serial cable (HD2110CSNM code), provided with a subD 9 poles connector.

**Note:** inserting the connector, be sure that the arrow printed on surface is upwards.

The connector description is indicated in the "SERIAL INTERFACE" chapter.

### USB Connector

**USB** connector type B for the connection of the vibration analyzer to the USB port of a PC with CP22 code cable.

The pin numbering is seen from outside.

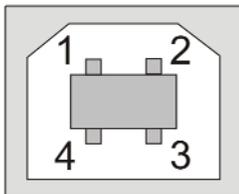

PIN	DESCRIPTION
1	+5Vdc
2	Data -
3	Data +
4	Ground

## TECHNICAL SPECIFICATIONS

The HD2030 vibrations analyzer is able to detect the accelerations in four axis.

The sensors that can be connected are IEPE type with amplifying integrated electronics, triaxial or monoaxial type.

Three axes are grouped in the right channel that supports triaxial or monoaxial type accelerometers; the fourth axis is associated with the left channel that supports monoaxial accelerometers. The instrument analyzes the signal provided by the accelerometers and elaborates the four axes data at the same time. The instrument perform octave or third-octave bands spectrum analysis and statistical analysis.

### ***The HD2030 vibrations analyzer complies with the following Rules:***

- ISO 8041:2005 "Human response to vibration – Measuring instrumentation"
- ISO 5349-1:2001 " Mechanical vibration – Measurement and evaluation of human exposure to hand-transmitted vibration – General requirements"
- ISO 5349-2:2001 " Mechanical vibration – Measurement and evaluation of human exposure to hand-transmitted vibration – Practical guidance for measurement at the workplace"
- ISO 2631-1:1997 "Mechanical vibration and shock – Evaluation of human exposure to whole body vibration – General requirements"
- ISO 2631-2:1989 "Evaluation of human exposure to whole body vibration – Continuous and shock-induced vibrations in buildings (1 to 80 Hz)"
- ISO 2631-4:2001 "Evaluation of human exposure to whole body vibration – Guidelines for the evaluation of the effects of vibration and rotational motion on passenger and crew comfort in fixed-guideway transport systems"
- ISO 2631-5:2004 "Evaluation of human exposure to whole body vibration – Method for evaluation of vibration containing multiple shocks"
- IEC 61260:1995 "Electroacoustics – Octave band and fractional-octave band filters"
- ISO 6954:2000 "Mechanical vibration - Guidelines for the measurement, reporting and evaluation of vibration with regard to habitability on passenger and merchant ships".

### ***Accelerometers models***

It is possible to connect triaxial or monoaxial accelerometers with integrated electronics (IEPE type or equal). The accelerometers are current supplied with a polarization voltage of 25V and a maximum current of 2mA. With the HD2030 analyzer can be supplied the following accelerometers:

### ***Accessories***

The following accessories are supplied on request:

- **HD6188:** tube of hydro-repellent silicone grease and electrically insulating.
- **HD6273:** tray with bonding wax.
- **080A90:** glue for quick fastening.
- **081B05:** double threaded screw 10-32 UNF.
- **081A90:** double threaded screw 5-40 UNC and 10-32 UNF.
- **M081B05:** double threaded screw 10-32 UNF and M6 X 0.75.
- **M081A27:** double threaded screw 10-32 UNF and M3 X 0.5".
- **081A27:** double threaded screw 5-40 UNC.
- **HD6239:** accelerometer push-rod.
- **HD6286:** adhesive metallic plate for assembly through magnet. Used to magnetically couple the accelerometer on non-metal surfaces.
- **HD6284:** insulated magnetic base with 10-32 UNF threaded hole.
- **HD6196:** magnetic base with integrated 10-32 UNF screw.
- **HD6226:** adhesive mounting base with threaded through hole (10-32 UNF).
- **HD6245:** adhesive mounting insulated base with integrated screw 10-32 UNF.
- **HD6220:** insulated base with integrated mounting 10-32 UNF screw and threaded hole 10-32 UNF for accelerometer mounting.

## METROLOGICAL SPECIFICATIONS

The HD2030 vibrations analyzer can perform measurement on the hand-arm system, the whole body or vibrations transmitted by the buildings. The weighting filters and the frequency range of the filters with constant percentage octave or third-octave band depend on the chosen analysis mode.

### **Frequency Weighting for RMS measurements:**

- Fz, Fc e Wh for the measurement on the hand-arm system
- Fz, Fa, Wb, Wc, Wd, We, Wj, Wk for the whole body measurements
- Fz, Fm e Wm for the measurements of whole body transmitted by the buildings vibrations.

The Fz weighting is flat on all the frequency range with the following features:

<b>Fz High-pass OFF Attenuation [dB]</b>	<b>Frequency range [Hz]</b>
< 0.1	1.25 ÷ 1600
< 1	0.4 ÷ 3200
< 3	0.2 ÷ 3700

Activating the High Pass filter (Menu >>Parameters >> Instrument >> Measurement >> High-Pass filter) the Fz weighting have the following features:

<b>Fz High-pass ON Attenuation [dB]</b>	<b>Frequency range [Hz]</b>
< 0.1	4 ÷ 1600
< 1	1.25 ÷ 3200
< 3	0.7 ÷ 3700

The Fa, Fm and Fc weightings are band-pass filters with the following features (High-Pass OFF):

<b>Filter</b>	<b>Band Limits (to -3dB) [Hz]</b>
Fa	0.4 ÷ 100
Fm	0.8 ÷ 100
Fc	6.3 ÷ 1250

The Wb, Wc, Wd, We, Wj, Wk and Wm filters respect ISO 8041:2005 standard.

### **Octave or third-octave bands spectral Analysis**

The constant percentage band filters comply with the rule IEC 61260. The range of the central frequencies depends on the selected application as reported in the following table.

<b>Application</b>	<b>Central frequencies range</b>	
	<b>Octave bands</b>	<b>Third-octave bands</b>
	<b>[Hz]</b>	
Hand-Arm	4 ÷ 2000	3.15 ÷ 3150
Whole body	0.5 ÷ 250	0.315 ÷ 315
Building vibration	0.5 ÷ 250	0.315 ÷ 315

**Self-generated noise**

The intrinsic noise, for the different frequency weightings and for constant percentage bands, both in octave and third-octave, is measured short-circuiting the input channels. For the Hand-Arm measurements, the detected values are indicated in the following tables:

HAND ARM			
Weightings	Fz	Fc	Wh
[ $\mu V$ ]	17	10	7

Center frequency octave bands [Hz]	4	8	16	32	63	125	250	500	1000	2000
[ $\mu V$ ]	4	4	3	3	4	4	4	5	6	7

Center frequency third-octave bands [Hz]	3.2	4	5	6.3	8	10	12.5	16	20	25
[ $\mu V$ ]	2	2	2	2	2	2	2	2	2	2

Center frequency third-octave bands [Hz]	32	40	50	63	80	100	125	160	200	250	315
[ $\mu V$ ]	2	2	2	2	2	2	2	2	2	3	3

Center frequency third-octave bands [Hz]	400	500	630	800	1k	1.3k	1.6k	2k	2.5k	3.2k
[ $\mu V$ ]	3	3	3	3	3	4	4	5	5	5

For Whole-Body measurements, the detected values are indicated in the following tables:

WHOLE BODY								
Weightings	Fz	Fa	Wb	Wc	Wd	We	Wj	Wk
[ $\mu V$ ]	21	14	8	13	13	11	10	9

Central Frequency octave bands [Hz]	0.5	1	2	4	8	16	32	63	125	250
Self-generated Noise [ $\mu V$ ]	8	6	5	3	5	2	2	3	3	3

Central Frequency third-octave bands [Hz]	0.32	0.4	0.5	0.63	0.8	1	1.25	1.6	2	2.5
Self-generated Noise [ $\mu V$ ]	5	5	4	4	4	4	3	3	3	2

Central Frequency third-octave bands [Hz]	3.2	4	5	6.3	8	10	12.5	16	20	25
Self-generated Noise [ $\mu V$ ]	2	2	2	2	2	2	1	1	1	1

Central Frequency third-octave bands [Hz]	32	40	50	63	80	100	125	160	200	250	315
Self-generated Noise [ $\mu V$ ]	1	1	1	2	2	2	2	2	2	2	2

For building vibrations measurements, the values are indicated in the following tables:

BUILDING VIBRATIONS			
Weightings	Fz	Fm	Wm
[uV]	21	13	10

For the Buildings Vibration measurements, the detected values of the octave and third-octave bands noise is the same detected for the Whole Body measurements.

#### Linearity range

The linearity range is independent from the frequency and it is equal to **80dB**. The maximum measurable level depends on the gain of the input amplifier as indicated in the following table:

Gain [dB]	Lower Limit [mVrms]	Upper Limit [Vrms]
0	0.7	7
10	0.22	2.24
20	0.07	0.7

As an example, following are indicated the linear ranges for two different sensitivity of the accelerometer.

Gain [dB]	Linear range with accelerometer			
	Sensitivity 10mV/g ~ 1mV/m/s <sup>2</sup>		Sensitivity 1V/g ~ 100mV/m/s <sup>2</sup>	
0	0.7 ÷ 7000 m/s <sup>2</sup>	117 ÷ 197 dB	0.7 cm/s <sup>2</sup> ÷ 70 m/s <sup>2</sup>	77 ÷ 157 dB
10	0.22 ÷ 2240 m/s <sup>2</sup>	107 ÷ 187 dB	0.22 cm/s <sup>2</sup> ÷ 22.4 m/s <sup>2</sup>	67 ÷ 147 dB
20	0.07 ÷ 700 m/s <sup>2</sup>	97 ÷ 177 dB	0.07 cm/s <sup>2</sup> ÷ 7 m/s <sup>2</sup>	57 ÷ 137 dB

#### Integration Time

The integration time can be set from a minimum of 1s to a maximum of 99 hours.

#### Crosstalk

The crosstalk between channels is <100dB@1kHz.

#### Reference conditions

- The measure range is the one with input gain equal to 10dB.
- The level is equal to 10mV corresponding to 140dB or 10m/s<sup>2</sup> for an accelerometer with a sensitivity equal to 10mV/g.

#### Operating conditions

- Storage temperature: -25 ÷ 70°C.
- Working temperature: -10 ÷ 50°C.
- Protection Degree: IP64.

#### Drift

- Temperature: ± 0.3dB over the range -10 ÷ 50°C.

## ELECTRICAL FEATURES

#### Pre-heating time

Less than 1 minute.

#### Power supply

- Internal batteries: 4 x 1.5 V alkaline or NiMH rechargeable batteries type AA. The instrument does not charge the batteries.

- Autonomy: > 10 hours in acquisition (RUN) mode with good quality alkaline batteries.
- External batteries: it is possible to connect an external battery pack to the instrument through the male connector for external power supply (Ø 5.5mm-2.1mm pin). The positive pole has to be connected to the central pin. The battery has to supply 9÷12V with at least 300mA/h. The maximum limit for external supply is 15V.
- Mains: mains adaptor with 9÷12Vdc/300mA direct voltage.
- Switching off: automatic, it can be disabled.

When the batteries voltage is less than 3.8V, the instrument is not able to measure. However, it is still possible to view and download the memorized data. Under 3.5V the instrument switches itself off automatically. The memorized data, the configuration and the calibration parameters are kept also without power supply.

### ***Maximum input levels***

The input signal must be in the range 0V÷25V.

### ***LINE outputs***

- Multi-pole circular connector (LEMO)
- Pre-amplified signal not pondered with an gain equal to 0.1V/V.
- Linearity: 110dB with maximum output level equal to 1.5Vrms.
- Series impedance: 1kΩ
- Typical load: 100kΩ

### ***TRGOUT output***

- Jack stereo socket Ø 3.5mm
- Digital output 0 ÷ 3.3V short-circuit protected
- Pull-up impedance : 1kΩ
- Pull-down impedance: 30Ω

### ***TRGIN input (Advanced Analyzer option)***

- Jack stereo socket Ø 3.5mm
- Current input: threshold 0.5mA max 20mA
- Voltage input: threshold 2V max 10V
- Series impedance: 470 Ω

### ***RS232 Serial Interface:***

- Socket: MiniDin 8 poles.
- Type: RS232C (EIA/TIA574) not isolated
- Baud rate: from 300 to 115200baud
- Data bit: 8
- Parity: None
- Stop Bit: 1
- Flow Control: Hardware
- Cable length: max 15m

### ***USB Serial Interface:***

- Socket: USB-B
- Type: USB 1.1 o 2.0 with 500mA

## STATISTICAL ANALYSIS

Statistical analysis is calculated on the chosen profile screen descriptor (Menu >> Parameters >> Vibration Analyzer >> Profile). Analysis is made with:

- 1s sampling.
- 1dB classes.

### ***Calculation and display of the statistical graphs.***

Graph of the levels probability distribution.

Graph of the percentile levels from  $L_1$  to  $L_{99}$ .

## SPECTRAL ANALYSIS

Acceleration signals spectral analysis is calculated in parallel with other calculations on all the four 4 channels

- Sampling: 8 kHz
- Resolution: 25bit

### ***Average spectrum or Multi-spectrum with 1 second sampling period.***

Octave bands from 4 Hz to 2kHz for hand-arm measurements and from 0.5Hz to 250Hz for whole body or buildings measurements.

Third-octave bands from 3.2Hz to 3.2kHz or from 0.32Hz to 315Hz

Ratio of the center frequencies: base 2

## VISUALIZATION

### ***Graphic Display***

128x64 pixel with 56x38mm wide backlit.

### ***Mode:***

- VLM\_1 and VLM\_3 (vibration level meter) screens, each one with 3 parameters at choice for acceleration measurements related to the single channel.
- VLM\_2 and VLM\_4 (vibration level meter) screens, each one with 3 parameters at choice for acceleration measurements related to the vector formed by 1,2 and 3 channels.
- time profile of a parameter at choice with sampling time from 1s to 1 hour.
- Octave or third-octave spectrum.
- probability distribution of levels in 1dB classes.
- Graph of the percentile levels from  $L_1$  to  $L_{99}$ .

## MEASUREMENTS STORAGE

8MB permanent internal memory FLASH type

Card slot for SD memory type up to 2GByte

### ***Safety of memorized data***

Independent from the condition of the batteries charge.

## OTHER FEATURES

### **Print**

It is possible to activate the automatic printing of the acquired parameters at the end of the measurement. The printer must be connected to the RS232 interface.

### **Vocal comments**

It's possible to add a vocal comment to every measurement stored on the flash internal memory or on the memory card. Stored vocal comments can be listened using the "Navigator" program. For recording and listening vocal comments it's necessary to connect a microphone and headphones on the dedicated connector placed on the frontal panel.

### **Digital recording**

On the SD memory card, it's possible to record raw digital samples coming from accelerometer's signals, in parallel with the standard recording functions. Signals digitization has the following properties:

- Sampling frequency: 8 ksmp/s
- Resolution: 0.05%
- Dynamic: 100dB

By setting the parameter Menu >> Parameters >> Data Logger >> Profiles >> ADC Channels the digital recording function can be activated. The user can activate one single channel chosen from the four available, only the first three or all simultaneously.

### **Slot**

- Dimensions (Length x Width x Height): 245x100x50mm,
- Weight: 740g (complete with batteries)
- Materials: ABS, rubber

### **Time:**

- Date and time: clock and calendar updated in real time
- Maximum deviation: 1min/month

## ACCELEROMETERS TECHNICAL SPECIFICATIONS

The HD2030 analyzer can be supplied with the following monoaxial accelerometers:

### HDD3200B5T Model

<b>Type:</b>	Dytran production accelerometer with integrated electronics (LIVM™). This sensor is usually used for hand-arm measurements when extremely high vibration levels at high frequency need to be measured or for shock measurements.
<b>Sensitivity:</b>	1mV/g
<b>Measure range:</b>	±50000 m/s <sup>2</sup>
<b>Frequency response:</b>	0.5Hz ÷ 40kHz
<b>Resonance frequency:</b>	130kHz
<b>Linearity:</b>	1% F.S.
<b>Transverse sensitivity:</b>	3% max
<b>Maximum Shock:</b>	50000gpk
<b>Working Temperature:</b>	-50°C ÷ 120°C
<b>Polarization Voltage:</b>	8.5Vdc
<b>Mechanical features:</b>	
• Weight:	6gr
• Dimensions:	(hex-diameter x height) 12.7mm x 23.1mm
• Mounting:	integrated screw 10-32 UNF-2A
• Connector:	upper micro coaxial 10-32
• Material:	stainless steel
• Isolation:	>10Mohm between the enclosure and the ground terminal
<b>Cable (not included):</b>	HD2030.CAB13 + HD2030CAB1B to connect to the analyzer's triaxial input and HD2030.CAB1-xM (3m, 5m e 10m) to connect the monoaxial input

### HDD3019A1 model

<b>Type:</b>	Dytran production accelerometer with integrated electronics (LIVM™). This sensor is normally used for hand-arm measurements.
<b>Sensitivity:</b>	10 mV/g
<b>Measure range:</b>	±5000 m/s <sup>2</sup>
<b>Frequency response (±5%):</b>	1 Hz ÷ 10 kHz
<b>Resonance frequency:</b>	50 kHz
<b>Linearity:</b>	2% F.S.
<b>Transverse sensitivity:</b>	5% max
<b>Maximum Shock:</b>	3000 gpk
<b>Working Temperature:</b>	-50 °C ÷ 150 °C
<b>Polarization Voltage:</b>	10 Vdc
<b>Mechanical features:</b>	
• Weight:	8 gr
• Dimensions:	(hex-diameter x height) 9.6 mm x 18.6 mm
• Mounting:	integrated screw 10-32 UNF
• Connector:	upper micro coaxial 10-32
• Material:	stainless steel
• Isolation:	enclosure connected to ground terminal
<b>Cable (not included):</b>	HD2030.CAB13 + HD2030CAB1B to connect to the analyzer's triaxial input and HD2030.CAB1-xM (3m, 5m e 10m) to connect the monoaxial input.

### **Modello HDP352C34**

<b>Type:</b>	PCB Piezotronics production accelerometer with integrated electronics (ICP™). This sensor is normally used for whole body measurements.
<b>Sensitivity:</b>	100 mV/g
<b>Measure range:</b>	±500 m/s <sup>2</sup>
<b>Frequency response (±5%):</b>	0.5 Hz ÷ 10 kHz
<b>Resonance frequency:</b>	50 kHz
<b>Linearity:</b>	1% F.S.
<b>Transverse sensitivity:</b>	5% max
<b>Maximum Shock:</b>	5000 gpk
<b>Working Temperature:</b>	-54 °C ÷ 93 °C
<b>Polarization Voltage:</b>	10 Vdc
<b>Mechanical features:</b>	
• Weight:	5.8 gr
• Dimensions:	(hex-diameter x height) 11.2 mm x 22.4 mm
• Mounting:	threaded hole 10-32 UNF
• Connector:	upper micro coaxial 10-32
• Material:	titanium
• Isolation:	>10Mohm between the enclosure and the ground terminal
<b>Included accessories:</b>	
• Screw:	double thread 10-32 UNF copper-beryllium alloy (081B05)
• Screw:	double thread 10-32 UNF and M6 copper-beryllium alloy (M081B05)
<b>Cable (not included):</b>	HD2030.CAB13 + HD2030CAB1B to connect to the analyzer's triaxial input and HD2030.CAB1-xM (3m, 5m e 10m) to connect the monoaxial input.

### **Modello HDD3056B2**

<b>Type:</b>	Dytran production accelerometer with integrated electronics (LIVM™). This sensor is normally used for whole body measurements.
<b>Sensitivity:</b>	100 mV/g
<b>Measure range:</b>	±500 m/s <sup>2</sup>
<b>Frequency response (±5%):</b>	1 Hz ÷ 10 kHz
<b>Resonance frequency:</b>	32 kHz
<b>Linearity:</b>	2% F.S.
<b>Transverse sensitivity:</b>	5% max
<b>Maximum Shock:</b>	2000 gpk
<b>Working Temperature:</b>	-51 °C ÷ 120 °C
<b>Polarization Voltage:</b>	11 Vdc
<b>Mechanical features:</b>	
• Weight:	10 gr
• Dimensions:	(hex-diameter x height) 12.7 mm x 23.2 mm
• Mounting:	threaded hole 10-32 UNF
• Connector:	upper micro coaxial 10-32
• Material:	titanium
• Isolation:	>10Mohm between the enclosure and the ground terminal
<b>Included accessories:</b>	
• Screw:	double thread 10-32 UNF copper-beryllium alloy (081B05)
<b>Cable (not included):</b>	HD2030.CAB13 + HD2030CAB1B to connect to the analyzer's triaxial input and HD2030.CAB1-xM (3m, 5m e 10m) to connect the monoaxial input.

<b>Type:</b>	Accelerometer with integrated electronics (LIVM™). This sensor is suitable for general use.
<b>Sensitivity:</b>	100mV/g
<b>Measure range:</b>	±50g
<b>Frequency response:</b>	1Hz ÷ 10kHz (±5%)
<b>Resonance frequency:</b>	32kHz
<b>Linearity:</b>	2% F.S.
<b>Transverse sensitivity:</b>	5% max
<b>Maximum Shock:</b>	2000g
<b>Working Temperature:</b>	-50°C ÷ 120°C
<b>Thermal Drift:</b>	0.12%/°C
<b>Polarization Voltage:</b>	9Vdc ÷ 12Vdc
<b>Mechanical features:</b>	
• Weight:	10gr
• Dim.(mm):	(Hex-diameter x height) 12.7mm x 23.1mm
• Mounting:	Threaded hole on the base with a depth of 3.8mm for 10-32 UNF-2A screw (supplied)
• Connector:	upper micro coaxial 10-32
• Material:	titanium steel
• Isolation:	>10Mohm between the enclosure and the ground terminal

**The HD2030 analyzer can be supplied with the following triaxial accelerometers:**

**HDP356B20 type**

<b>Type:</b>	PCB Piezotronics production triaxial accelerometer with integrated electronics (ICP™). This sensor is normally used for hand-arm measurements.
<b>Sensitivity:</b>	1 mV/g
<b>Measure range:</b>	±50000 m/s <sup>2</sup>
<b>Frequency response (±5%):</b>	2 Hz ÷ 10 kHz (Y and Z axes) , 2 Hz ÷ 7 kHz (X axis)
<b>Resonance frequency:</b>	55 kHz
<b>Linearity:</b>	2.5% F.S.
<b>Transverse sensitivity:</b>	5% max
<b>Maximum Shock:</b>	7000 gpk
<b>Working Temperature:</b>	-55 °C ÷ 121 °C
<b>Polarization Voltage:</b>	9 Vdc
<b>Mechanical features:</b>	
• Weight:	4 gr
• Dimensions:	(height x width x depth) 10.2 mm x 10.2 mm x 10.2 mm
• Mounting:	2 threaded holes 5-40 UNC aligned with Y and Z axes
• Connector:	side 8-36 4 pin
• Material:	titanium
• Isolation:	connector coupled with the ground terminal
<b>Included accessories:</b>	
• Screw:	thread 5-40 UNC stainless steel to fix, using hexagonal wrench, to handle mounting adapters HD2030AC1-2-4
• Screw:	double thread 5-40 UNC and 10-32 UNF in copper-beryllium alloy (081A27)
• Screw:	double thread 5-40 UNC and 10-32 UNF in copper-beryllium alloy (081A90)
• Screw:	double thread 5-40 UNC and M3 in copper-beryllium alloy (M081A27)
<b>Cable (not included):</b>	HD2030.CAB3S-xM (3m, 5m e 10m) to connect accelerometer to analyzer.

### **HDD3023A2 Model**

<b>Type:</b>	Triaxial miniature accelerometer with integrated electronics (LIVM™). This sensor is usually used for hand-arm measurement.
<b>Sensitivity:</b>	10mV/g
<b>Measure range:</b>	±5000 m/s <sup>2</sup>
<b>Frequency response:</b>	1.5Hz ÷ 10kHz (-5% / +15%)
<b>Resonance frequency:</b>	40kHz
<b>Linearity:</b>	1% F.S.
<b>Transverse sensitivity:</b>	5% max
<b>Maximum Shock:</b>	5000g
<b>Working Temperature:</b>	-50°C ÷ 120°C
<b>Thermal Drift:</b>	0.06%/°C
<b>Polarization Voltage:</b>	10Vdc
<b>Mechanical features:</b>	
• Weight:	4gr
• Dims. (mm):	(height x width x depth) 12.5x9.15x9.15
• Mounting:	hole at the base for screw 10-32 UNF-2A (supplied)
• Connector:	side ¼-28 4 pin
• Material:	titanium steel
• Isolation:	enclosure connected to the ground terminal
<b>Included accessories:</b>	
• Screw:	double thread 10-32 UNF in copper-beryllium alloy (HD6200)
<b>Cable (not included):</b>	HD2030.CAB3S-xM (3m, 5m e 10m) to connect accelerometer to analyzer.

### **HDP356A02 type**

<b>Type:</b>	PCB Piezotronics production triaxial accelerometer with integrated electronics (ICP™). This sensor is normally used for hand-arm measurements.
<b>Sensitivity:</b>	10 mV/g
<b>Measure range:</b>	±5000 m/s <sup>2</sup>
<b>Frequency response (±5%):</b>	1 Hz ÷ 5 kHz
<b>Resonance frequency:</b>	25 kHz
<b>Linearity:</b>	2% F.S.
<b>Transverse sensitivity:</b>	5% max
<b>Maximum Shock:</b>	7000 gpk
<b>Working Temperature:</b>	-54 °C ÷ 121 °C
<b>Polarization Voltage:</b>	10 Vdc
<b>Mechanical features:</b>	
• Weight:	10.5 gr
• Dimensions:	(height x width x depth) 14 mm x 20.3 mm x 14 mm
• Mounting:	threaded hole 10-32 UNF aligned with Z axis
• Connector:	side ¼-28 4 pin
• Material:	titanium
• Isolation:	connector coupled with the ground terminal
<b>Included accessories:</b>	
• Screw:	double thread 10-32 UNF in copper-beryllium alloy (081B05)
• Screw:	double thread 10-32 UNF and M6 in copper-beryllium alloy (M081B05)
<b>Cable (not included):</b>	HD2030.CAB3S-xM (3m, 5m e 10m) to connect accelerometer to analyzer.

## HDP356B21 type

<b>Type:</b>	PCB Piezotronics production miniature triaxial accelerometer with integrated electronics (ICP™). This sensor is normally used for hand-arm measurements.
<b>Sensitivity:</b>	10 mV/g
<b>Measure range:</b>	±5000 m/s <sup>2</sup>
<b>Frequency response (±5%):</b>	2 Hz ÷ 10 kHz for Y and Z axes, 2 Hz ÷ 7 kHz for X axis
<b>Resonance frequency:</b>	55 kHz
<b>Linearity:</b>	1% F.S.
<b>Transverse sensitivity:</b>	5% max
<b>Maximum Shock:</b>	10000 gpk
<b>Working Temperature:</b>	-54 °C ÷ 121 °C
<b>Polarization Voltage:</b>	9 Vdc
<b>Mechanical features:</b>	
• Weight:	4 gr
• Dimensions:	(height x width x depth) 10.2 mm x 10.2 mm x 10.2 mm
• Mounting:	two threaded holes 5-40 UNC aligned with Y and Z axes
• Connector:	side 8-36 4 pin
• Material:	titanium
• Isolation:	connector coupled with the ground terminal
<b>Included accessories:</b>	
• Screw:	thread 5-40 UNC stainless steel to fix, using hexagonal wrench, to handle mounting adapters HD2030AC1-2-4
• Screw:	double thread 5-40 UNC in copper-beryllium alloy (081A27)
• Screw:	double thread 5-40 UNC and 10-32 UNF in copper-beryllium alloy (081A90)
• Screw:	double thread 5-40 UNC and M3 in copper-beryllium alloy (M081A27)
<b>Cable (not included):</b>	HD2030.CAB3S-xM (3m, 5m e 10m) to connect accelerometer to analyzer.

## HDP356A22 type

<b>Type:</b>	PCB Piezotronics production miniature triaxial accelerometer with integrated electronics (ICP™). This sensor is normally used for whole body measurements.
<b>Sensitivity:</b>	100 mV/g
<b>Measure range:</b>	±500 m/s <sup>2</sup>
<b>Frequency response (±5%):</b>	0.5 Hz ÷ 4 kHz
<b>Resonance frequency:</b>	25 kHz
<b>Linearity:</b>	1% F.S.
<b>Transverse sensitivity:</b>	5% max
<b>Maximum Shock:</b>	5000 gpk
<b>Working Temperature:</b>	-54 °C ÷ 77 °C
<b>Polarization Voltage:</b>	10 Vdc
<b>Mechanical features:</b>	
• Weight:	5.4 gr
• Dimensions:	(height x width x depth) 11.4 mm x 11.4 mm x 11.4 mm
• Mounting:	two threaded holes 5-40 UNC aligned with Y and Z axes
• Connector:	side 8-36 4 pin
• Material:	titanium
• Isolation:	connector coupled with the ground terminal
<b>Included accessories:</b>	
• Screw:	double thread 5-40 UNC in copper-beryllium alloy (081A27)
• Screw:	double thread 5-40 UNC and 10-32 UNF in copper-beryllium alloy (081A90)

- Screw: double thread 5-40 UNC and M3 in copper-beryllium alloy (M081A27)

**Cable (not included):** HD2030.CAB3S-xM (3m, 5m e 10m) to connect accelerometer to analyzer.

### **HDP356B41 type**

**Type:** PCB Piezotronics production low profile triaxial accelerometer with integrated electronics (ICP™) inserted in a rubber pad. This sensor is normally used for whole body measurements; while installed in the specific rubber pad it can be used to measure seat and seat-back transmitted vibrations.

**Sensitivity:** 100 mV/g  
**Measure range:** ±100 m/s<sup>2</sup>  
**Frequency response (±5%):** 0.5 Hz ÷ 1 kHz  
**Resonance frequency:** 27 kHz  
**Linearity:** 1% F.S.  
**Transverse sensitivity:** 5% max  
**Maximum Shock:** 2000 gpk  
**Working Temperature:** -10 °C ÷ 50 °C  
**Polarization Voltage:** 3.5 Vdc

**Mechanical features:**

- Weight: 10.8 gr (272 gr including the rubber pad)
- Dimensions: (height x width x depth) 9 mm x 32 mm x 21.5 mm
- Pad dimensions: (diameter x thickness) 200 mm x 12 mm
- Mounting: threaded through-hole 10-32 UNF aligned with Z axis
- Connector: side ¼-28 4 pin
- Material: titanium
- Isolation: connector coupled with the ground terminal

**Included accessories:**

- Cable: HD2030.CAB3-3M (3m) to connect accelerometer to analyzer.

### **HDP356B18 type**

**Type:** PCB Piezotronics production triaxial accelerometer with integrated electronics (ICP™). This sensor is normally used for whole body buildings transmitted vibration measurements.

**Sensitivity:** 1 V/g  
**Measure range:** ±50 m/s<sup>2</sup>  
**Frequency response (±5%):** 0.5 Hz ÷ 3 kHz  
**Resonance frequency:** 20 kHz  
**Linearity:** 1% F.S.  
**Transverse sensitivity:** 5% max  
**Maximum Shock:** 5000 gpk  
**Working Temperature:** -29 °C ÷ 77 °C  
**Polarization Voltage:** 10 Vdc

**Mechanical features:**

- Weight: 5.4 gr
- Dimensions: (height x width x depth) 20.6 mm x 26.1 mm x 20.3 mm
- Mounting: threaded holes 10-32 UNF aligned with Y and Z axes
- Connector: side ¼-28 4 pin
- Material: light alloy
- Isolation: connector coupled with the ground terminal

**Included accessories:**

- Screw: double thread 10-32 UNF in copper-beryllium alloy (081B05)

- Screw: Screw: double thread 10-32 UNF and M6 in copper-beryllium alloy (M081B05)
- Cable (not included):** HD2030.CAB3S-xM (3m, 5m e 10m) to connect accelerometer to analyzer.

### **HDD3233A type**

**Type:** Dytran production high sensitivity triaxial accelerometer with integrated electronics (LIVM™). This sensor is usually used for the measurement of the vibrations transmitted by the buildings.

**Sensitivity:** 1V/g  
**Measure range:** ±50 m/s<sup>2</sup>  
**Frequency response (±10%):** 0.4 Hz ÷ 6 kHz axis 3 and 0.4 Hz ÷ 3 kHz axes 1 and 2  
**Resonance frequency:** 20kHz  
**Linearity:** 1% F.S.  
**Transverse sensitivity:** 5% max  
**Maximum Shock:** 5000 gpk  
**Working Temperature:** -51 °C ÷ 93 °C  
**Polarization Voltage:** 12 Vdc

**Mechanical features:**

- Weight: 28gr
- Dimensions (mm): (height x width x depth) 13 mm x 33 mm x 25
- Mounting: central through hole (for M4 screw) aligned with axis 3
- Connector: side ¼-28 4 pin
- Material: titanium alloy
- Isolation: Body connected to the ground terminal and isolated from the mounting surface.

**Included accessories:**

- Screw: mounting screw

**Cable (not included):** HD2030.CAB3-xM (3m, 5m e 10m) to connect accelerometer to analyzer.

### **Accessories**

With the accelerometers, the following accessories are supplied as optionally:

- **HD6188:** tube of hydro-repellent silicone grease and electrically insulating.
- **HD6273:** tray with bonding wax.
- **O80A90:** glue for quick fastening.
- **O81B05:** double threaded screw 10-32 UNF.
- **O81A90:** double threaded screw 5-40 UNC and 10-32 UNF.
- **M081B05:** double threaded screw 10-32 UNF and M6 X 0.75.
- **M081A27:** double threaded screw 10-32 UNF and M3 X 0.5".
- **O81A27:** double threaded screw 5-40 UNC.
- **HD6239:** accelerometer push-rod.
- **HD6286:** adhesive metallic plate for assembly through magnet. Used to magnetically couple the accelerometer on non-metal surfaces.
- **HD6284:** insulated magnetic base with 10-32 UNF threaded hole.
- **HD6196:** magnetic base with integrated 10-32 UNF screw.
- **HD6226:** adhesive mounting base with threaded through hole (10-32 UNF).
- **HD6245:** adhesive mounting insulated base with integrated screw 10-32 UNF.
- **HD6220:** insulated base with integrated mounting 10-32 UNF screw and threaded hole 10-32 UNF for accelerometer mounting.

## REFERENCE STANDARDS

- **ISO 8041:2005** "Human response to vibration – Measuring instrumentation"
- **ISO 5349-1:2001** " Mechanical vibration – Measurement and evaluation of human exposure to hand-transmitted vibration – General requirements"
- **ISO 5349-2:2001** " Mechanical vibration – Measurement and evaluation of human exposure to hand-transmitted vibration – Practical guidance for measurement at the workplace"
- **ISO 2631-1:1997** "Mechanical vibration and shock – Evaluation of human exposure to whole body vibration – General requirements"
- **ISO 2631-2:1989** "Evaluation of human exposure to whole body vibration – Continuous and shock-induced vibrations in buildings (1 to 80 Hz)"
- **ISO 2631-4:2001** "Evaluation of human exposure to whole body vibration – Guidelines for the evaluation of the effects of vibration and rotational motion on passenger and crew comfort in fixed-guideway transport systems"
- **ISO 2631-5:2004** "Evaluation of human exposure to whole body vibration – Method for evaluation of vibration containing multiple shocks" **IEC 61260:1995** "Electroacoustics – Octave band and fractional-octave band filters"
- **ISO 6954:2000** "Mechanical vibration - Guidelines for the measurement, reporting and evaluation of vibration with regard to habitability on passenger and merchant ships".

## EMC STANDARDS

- |   |                        |
|---|------------------------|
| • Protection degree   | IP64                   |
| • Safety  | EN61010-1              |
| • Electromagnetic compatibility. Generic standard for immunity. Industrial environment.                                   | EN61000-6-2:2005       |
| • Electromagnetic compatibility. Generic standard for emission. Residential, commercial and light industry environments,. | EN61000-6-3:2007       |
| • Electrostatic discharge immunity  | EN61000-4-2 livello 3  |
| • Susceptibility to EMI   | EN61000-4-3 livello 3  |
| • Immunity to electrical fast transients  | EN61000-4-4 livello 3, |
| • Immunity to conducted disturbances  | EN61000-4-6            |
| • Electromagnetic Interference - Conducted Emissions  | EN55022:2007 classe B  |
| • Electromagnetic interference - Radiated Emissions   | IEC/CISPR 22 classe B  |

## ITALIAN STANDARDS

- Vibrations in the workplace: : D.Lgs 81/2005 and 2002-44-CE European Directive.

## ORDER CODES

- HD2030.K1:** **Kit vibration analyser, 4 channels, for IEPE accelerometers**  
It includes: HD2030 analyzer with four channels, user manual, suitcase, Noise Studio Software basic module, serial cable for USB (CP22) ports, 1GB memory card (HD2030MC), silicone grease (HD6188), wax tray for gluing (HD6273) and fast mounting wax (080A90). Calibration reports for HD2030 according to ISO8041 and for octave and third octave filters bank according to IEC61260.  
**At the time of order, specify the accelerometers, the connection cables and the accessories.**
- HD2030.Ha-Wb:** **Kit HD2030 for four-axial measurement of hand-arm transmitted vibrations and whole body transmitted vibrations using a rubber pad on the seat and seat back.** The kit is composed of four channels vibration analyzer including spectral and statistical analysis , two triaxial accelerometers and rubber pad for the seat. The kit includes adapters for hand-arm accelerometer mounting.  
Includes:
- HD2030.K1: 4-axis HD2030 vibration analyser, user manual, carrying case, Noise Studio basic software, serial cable for USB ports (CP22), 1GB SD memory card (HD2030MC), silicon grease (HD6188), tray with bonding wax (HD6273) and quick fastening glue (080A90). Calibration reports for vibration meter and filters according to ISO8041 and IEC61260.
  - IEPE tri-axial accelerometer with 10 mV/g sensitivity for the measurement of vibrations transmitted to the hand-arm. Includes mounting screw in copper-beryllium and HD2030.CAB3-3M connection cable to analyser. Sensor's manufacturer calibration chart and calibration report according to ISO 8041 of the measurement chain composed of the three axes and the analyser with Wh weighting filters.
  - IEPE triaxial accelerometer with 100mV/g sensitivity for the measurement of whole body transmitted vibrations; the accelerometer is mounted into a rubber pad for the measurement on seats and seat back. It includes HD2030.CAB3-3M connection cable to analyser. Sensor's manufacturer calibration chart and calibration report according to ISO 8041 of the measurement chain composed of the three axes and the analyser with Wd, Wd and Wk weighting filters for X, Y and Z axes respectively.
  - Adapters to fix the accelerometer to the handles of tools (HD2030.124). Are included: HD2030AC1 cubic adapter with metal clamp, HD2030AC2 adapter for cylindrical shape handles and HD2030AC4 adapter for small tools with anatomic handles
- HD2030.SL:** **Kit HD2030 "Safety in the Workplace" for the measurement of noise and vibration in the workplace.** The kit consists of HD2030 four-axes vibration analyzer with accelerometers to measure the vibration transmitted to the hand-arm and whole body and HD2010UC/A type 1 sound level meter and analyzer.  
includes:
- HD2030.HA-WB: Kit for hand-arm and whole-body four-axis vibration measurements including the four-channels HD2030 vibration analyzer, two triaxial accelerometers and hand-arm adapters.

- HD2010UC/A type 1 sound level meter, octave bands spectrum analyzer and statistical analyzer, user manual, carrying case, HD2010PNE2 detachable preamplifier and pre-polarized (electret) microphone, 5m extension cable (CPA/5), windshield and USB serial cable. Calibration report of sound level meter and filters.
- Noise Studio "Worker Protection" (NS1) application module with hardware key (CH20) and license of use, for noise and vibration analysis in the workplace according to UNI 9432/11 and ISO9612/11.

**HD2030.RV:**

**Kit HD2030 "Noise and Vibration" for the measurement of noise and vibration in the workplace and for the assessment of noise pollution and environmental noise in general.** The kit consists of HD2030 four-axes vibration analyzer with accelerometers to measure the vibration transmitted to the hand-arm and whole body and a HD2110L type 1 sound level meter and analyzer.

includes:

- HD2030.HA-WB: Kit for hand-arm and whole-body four-axis vibration measurements including the four-channels HD2030 vibration analyzer, two triaxial accelerometers and hand-arm adapters.
- HD2110L type 1 sound level meter with option HD2110.O1 "Third Octave": octave and third octave (with double filter bank for tonal components assessment) bands spectrum analyzer and statistical analyzer, user manual, carrying case, HD2110P preamplifier and high sensitivity detachable microphone, 5m extension cable (CPA/5), HD SAV windshield and USB serial cable. Calibration report of sound level meter and filters.
- Noise Studio **NSLA** package composed of hardware key (CH20) and license of use for:
  - Noise Studio NS1 "Workers Protection" application module for noise and vibration analysis in the workplace according to UNI 9432/11 and ISO9612/11.
  - Noise Studio NS5 "Environmental Noise" application module for assessment of environmental noise sources according to national and EU standards regarding environmental noise.

**For availability and delivery time of the following accelerometers please contact your local distributor.**

**HDD3200B5T:** accelerometer with integrated electronics (LIVM™) for hand-arm measurements in the presence of shock levels. *Sensitivity* 1mV/g, *range*  $\pm 50000$  m/s<sup>2</sup>, Integrated mounting screw. Can be connected to left (monoaxial) vibration analyzer input using HD2030.CAB1-xM cable or to right (triaxial) analyzer input using HD2030.CAB13 and HD2030CAB1B-xM (not included).

**HDD3019A1:** Dytran production accelerometer with integrated electronics (LIVM™) for hand-arm vibration measurements. Sensitivity 10 mV/g, measure range  $\pm 5000$  m/s<sup>2</sup>. Mounting screw included. Can be connected to left (monoaxial) vibration analyzer input using HD2030.CAB1-xM cable or to right (triaxial) analyzer input using HD2030.CAB13 and HD2030CAB1B-xM (not included).

**HDP352C34:** PCB Piezotronics production accelerometer with integrated electronics (ICP™) for whole body transmitted vibration measurements. Sensitivity 100 mV/g, range  $\pm 500$  m/s<sup>2</sup>. Mounting screws 10-32 UNF and M6 included. Can be connected to left (monoaxial) vibration analyzer input using HD2030.CAB1-xM cable or to right (triaxial) analyzer input using HD2030.CAB13 and HD2030CAB1B-xM (not included).

**HDD3056B2:** Dytran production accelerometer with integrated electronics (LIVM™) for whole body transmitted vibration measurements. Sensitivity 100 mV/g, measure range:  $\pm 500$  m/s<sup>2</sup>. Mounting screw 10-32 UNF included. Can be connected to left (monoaxial) vibration analyzer input using HD2030.CAB1-xM cable or to right (triaxial) analyzer input using HD2030.CAB13 and HD2030CAB1B-xM (not included).

### **Triaxial accelerometers**

**HDP356B20:** PCB Piezotronics production miniature triaxial accelerometer with integrated electronics (ICP™) for hand-arm vibration measurements in the presence of high peak levels. Sensitivity 1 mV/g, measure range  $\pm 50000$  m/s<sup>2</sup>. Mounting screws 5-40 UNC, 10-32 UNF and M3 included. Can be connected to the right (triaxial) analyzer's input using the HD2030.CAB3S-xM cable (not included).

**HDD3023A2:** Dytran production triaxial miniature accelerometer with integrated electronics (LIVM™) for hand-arm measurements. Sensitivity 10mV/g, measure range:  $\pm 5000$  m/s<sup>2</sup>. Mounting screw HD6200 is included. Can be connected to the right (triaxial) analyzer's input using the HD2030.CAB3S-xM cable (not included).

**HDP356A02:** PCB Piezotronics production triaxial accelerometer with integrated electronics (ICP™) for hand-arm vibration measurements. Sensitivity 10, mV/g, measure range  $\pm 5000$  m/s<sup>2</sup>. Mounting screws 10-32 UNF and M6 included. Can be connected to the right (triaxial) analyzer's input using the HD2030.CAB3S-xM cable (not included).

**HDP356B21:** PCB Piezotronics production miniature triaxial accelerometer with integrated electronics (ICP™) for hand-arm vibration measurements. Sensitivity 10 mV/g, measure range  $\pm 5000$  m/s<sup>2</sup>. Mounting screws 5-40 UNC, 10-32 UNF and M3 included. Can be connected to the right (triaxial) analyzer's input using the HD2030.CAB3S-xM cable (not included).

**HDP356A22** PCB Piezotronics production miniature triaxial accelerometer with integrated electronics (ICP™) for whole body transmitted vibration measurements. Sensitivity 100 mV/g, measure range  $\pm 500$  m/s<sup>2</sup>. Mounting screws 5-40 UNC, 10-32 UNF and M3 included. Can be connected to the right (triaxial) analyzer's input using the HD2030.CAB3S-xM cable (not included).

**HDP356B41:** PCB Piezotronics production triaxial accelerometer with integrated electronics (ICP™) for whole body transmitted vibration measurements. Sensitivity 100 mV/g, measure range  $\pm 100$  m/s<sup>2</sup>. Accelerometer is mounted into a rubber pad for the vibration measurements in seats and seat back. HD2030.CAB3-3M cable for connection to analyzer input included.

**HDP356B18:** PCB Piezotronics production triaxial accelerometer with integrated electronics (ICP™) for vibration measurements in buildings. Sensitivity 1 V/g, measure range  $\pm 50 \text{ m/s}^2$ . Mounting screws 10-32 UNF and M6 included. Can be connected to the right (triaxial) analyzer's input using the HD2030.CAB3S-xM cable (not included).

**HDD3233A:** Dytran production high sensitivity triaxial accelerometer with integrated electronics (LIVM™) for vibrations measurements in buildings. Sensitivity 1V/g, measure range  $\pm 50 \text{ m/s}^2$ . Mounting screw M4 included. Can be connected to the right (triaxial) analyzer's input using the HD2030.CAB3S-xM cable (not included).

### **Supports for hand-arm measurements**

**HD2030AC1:** Cubic support for the accelerometer mounting on grips through plastic or metal bands as close as possible to the hand. It is suitable for measurements on small tools where the weight of the measurement chain must be minimized. Material: light alloy.

It includes:

- hex socket screw 10-32UNF
- 4mm hexagonal key
- 10 plastic cable ties, 4.5mm width, 200 mm length
- 1 metallic clamp , width 9 mm

**HD2030AC2:** Adapter to be placed between the hand and the grip. The accelerometer is fixed in lateral position, at the left or right of the hand. It is suitable for large cylindrical grips. Material: light alloy.

It includes:

- hex socket screw 10-32UNF
- 4mm hexagonal key
- 10 plastic cable ties, 4.5mm width, 200 mm length
- 1 metallic clamp 9mm width
- 2 velcro straps, width 25mm, length 300mm (HD2030FV)

**HD2030AC3:** adapter to be placed between the hand and the grip The accelerometer is fixed in lateral position, at the left or right of the hand. It is suitable for cylindrical grips with large dimensions and for accelerometer with integrated screw. Material: inox.

It includes:

- 10 plastic cable ties, 4.5mm width, 200 mm length
- 2 velcro straps 24.5m width, length 300mm (HD2030FV)

**HD2030AC4:** adapter to be place between the hand and the grip The accelerometer is fixed in central position, between the middle-finger and ring-finger or between the forefinger and middle-finger. It is suitable for anatomic grips even if not cylindrical and with small dimensions.

Material: light alloy.

It includes:

- hex socket screw 10-32UNF
- 4mm hexagonal key
- 10 plastic cable ties, 4.5mm width, 200 mm length
- 2 velcro straps, width 25mm, length 300mm (HD2030FV)

**HD2030AC5:** Support for triaxial and monoaxial accelerometers suitable for the measurement of the vibrations transmitted by floors and vibrating surfaces in general. It is provided with a spirit level and three support feet, two with adjustable height. The support has a cavity for the installation of a triaxial accelerometer with central through hole for M4 screws. The upper surface has a 10-32 UNF threaded hole for the

mounting of an accelerometer. For the assembly of three monoaxial accelerometers it is supplied a cubic adapter to be mounted on the upper surface. Material: Nickel-plated steel, weight 1.9kg.

HD2030AC5 includes:

- Steel support with three feet and leveling device. It has a 10-32 UNF threaded hole on the upper surface and a cavity on the bottom side with M4 threaded hole.
- Cubic adapter to be mounted on the upper surface through two M4 screws (included). The cube has 10-32 UNF threaded holes on three orthogonal sides.
- 3mm hexagonal key

**HD2030.124:** adapters kit for the measurement of the vibrations transmitted to the hand-arm system.

Includes:

- HD2030AC1: cube-shaped adapter to be fastened to the handle with plastic cable-tie or metallic clamp (included).
- HD2030AC2: adapter for cylindrical handles. The adapter is placed laterally with respect to the hand.
- HD2030AC4: general purpose adapter. The accelerometer is placed between the forefinger and the middle-finger or between the middle-finger and the ring-finger.
- hex socket screw 10-32UNF
- 4mm hexagonal key
- 10 plastic cable ties, 4.5mm width, 200 mm length
- 1 metallic clamp , width 9 mm
- 2 velcro straps, width 25mm, length 300mm (HD2030FV)

**HD2030.1234:** adapters kit for the measurement of the vibrations transmitted to the hand-arm system.

Includes:

- HD2030AC1: cube-shaped adapter for anatomical handles and small size tools. The adapter has to be fastened to the handle with plastic cable-tie or metallic clamp (included).
- HD2030AC2: adapter for cylindrical handles. The adapter is placed laterally with respect to the hand.
- HD2030AC3: adapter for cylindrical handles provided with threaded hole for accelerometers with 10-32 UNF screw. The adapter is placed laterally with respect to the hand.
- HD2030AC4: general purpose adapter. The accelerometer is placed between the forefinger and the middle-finger or between the middle-finger and the ring-finger.
- hex socket screw 10-32UNF
- 4mm hexagonal key
- 10 plastic cable ties, 4.5mm width, 200 mm length
- 1 metallic clamp , width 9 mm
- 2 velcro straps, width 25mm, length 300mm (HD2030FV)

### ***Accelerometers mounting accessories***

**HD6188:** Tube of hydro-repellent silicone grease and electrically insulating.

**HD6273:** Tray with bonding wax.

**080A90:** quick mounting glue

<b>081B05:</b>		Copper-beryllium alloy screw with dual threading 10-32 UNF.
<b>081A27</b>		Double thread screw 5-40 UNC.
<b>081A90:</b>		Double thread screw 5-40 UNC and 10-32 UNF (copper-beryllium alloy).
<b>M081B05:</b>		Double thread screw 10-32 UNF and M6 x 0.75 (copper-beryllium alloy).
<b>M081A27</b>		Double thread screw 5-40 UNC and M3 x 0.5" (copper-beryllium alloy).
<b>HD6239:</b>		Push-rod for accelerometer. It can be used with all accelerometers.
<b>HD6286:</b>		Adhesive metallic disc. Used to magnetically couple the accelerometer to non-metallic surfaces. It can be used with HD6284 and HD6196 magnetic bases.
<b>HD6284:</b>		Small magnetic base with threaded hole 10-32UNF. It can be used with all accelerometers
<b>HD6196</b>		Large magnetic base with integrated screw 10-32UNF. It can be used with the following accelerometers: HDP356A02, HDD3056B2, HDP352C34 and HDP356B41 (removing rubber pad).
<b>HD6226:</b>		Base with threaded thru-hole 10-32 UNF for adhesive mounting. It can be used with all accelerometers.
<b>HD6245:</b>		Insulated Base with integrated screw 10-32 UNF for adhesive mounting. It can be used with the HDP356A02, HDD3056B2, HDP352C34 e HDP356B41 (removing the rubber pad).
<b>HD6220:</b>		Insulated Base with integrated mounting screw 10-32 UNF-2A and threaded hole 10-32 UNF for accelerometers assembly. It can be used with all accelerometers.
<b>HD2030FV</b>		Velcro strap, width 25mm, length 300mm

### Cables for monoaxial accelerometers

- HD2030.CAB13:** cable for the connection of three monoaxial accelerometers to the triaxial input of the HD2030 analyzer, complete with connectors. 40 cm length with BNC connectors. It is necessary to use a HD2030.CAB1B-xM cable for each accelerometer.
- HD2030.CAB1B-3M:** coaxial cable for the connection of monoaxial accelerometers to the HD2030.CAB13 cable, complete with connectors. 3m length.
- HD2030.CAB.BNC-xM:** coaxial extension cable for the connection of monoaxial accelerometers to the HD2030.CAB13 cable. The maximum cable length is 50m and both ends are terminated with BNC female connectors.
- HD2030.CAB1-3M:** low noise coaxial cable for the connection of monoaxial accelerometers to the HD2030 analyzer left input. 3m length, complete with connectors. Can be used with accelerometers: HDD3200B5T, HDD3019A1, HDP352C34 and HDD3056B2
- HD2030.CAB1-5M:** low noise coaxial cable for the connection of monoaxial accelerometers to the HD2030 analyzer left input. 5m length, complete with connectors. Can be used with accelerometers: HDD3200B5T, HDD3019A1, HDP352C34 and HDD3056B2
- HD2030.CAB1-10M:** low noise coaxial cable for the connection of monoaxial accelerometers to the HD2030 analyzer left input. 10m length, complete with connectors. Can be used with accelerometers: HDD3200B5T, HDD3019A1, HDP352C34 and HDD3056B2.

### Cables for triaxial accelerometers

- HD2030.CAB3-3M:** Cable for the connection of accelerometers to the HD2030 analyzer, complete with connectors. Length 3 m. It can be used with the accelerometers: HDP356B18, HDD3233A, HDD3023A2 and HDP356A02..
- HD2030.CAB3-5M:** Cable for the connection of accelerometers to the HD2030 analyzer, complete with connectors. Length 5 m. It can be used with the accelerometers: HDP356B18, HDD3233A, HDD3023A2 and HDP356A02..
- HD2030.CAB3-10M:** Cable for the connection of accelerometers to the HD2030 analyzer, complete with connectors. Length 10 m. It can be used with the accelerometers: HDP356B18, HDD3233A, HDD3023A2 and HDP356A02..
- HD2030.CAB3S-3M:** Cable for the connection of accelerometers to the HD2030 analyzer, complete with connectors. Length 3 m. It can be used with the accelerometers: HDP356B20, HDP356B21 and HDP356A22.
- HD2030.CAB3S-5M:** Cable for the connection of accelerometers to the HD2030 analyzer, complete with connectors. Length 5 m. It can be used with the accelerometers: HDP356B20, HDP356B21 and HDP356A22.
- HD2030.CAB3S-10M:** Cable for the connection of accelerometers to the HD2030 analyzer, complete with connectors. Length 10 m. It can be used with the accelerometers: HDP356B20, HDP356B21 and HDP356A22.

### Other cables

- HD2110CSNM:** PC connection serial cable for COM ports and for the direct connection to HD40.1 printer.
- CP22:** PC connection serial cable for USB ports with A and B type connectors.

### Other accessories

- HD2030MC:** 1GB SD memory card.
- HD2030AM:** headset with microphone.
- SWD10:** stabilized power supply 100-240Vac/12Vdc-1A.
- VTRAP:** tripod with a maximum height of 1550mm.

- HD40.1:** kit including 24-column portable thermal printer, serial interface, paper width 57 mm, 4 x 1.2V NiMH rechargeable batteries, SWD10 power supply device, 5 rolls of thermal paper and user manual.
- BAT-40:** spare battery pack for the printer HD40.1 with temperature integrated sensor.
- RCT:** kit of four rolls of thermal paper; 57mm width, 32mm diameter.

## HOW TO SOLVE THE PROBLEMS

The HD2030 analyzer is equipped with a diagnostic program (DIAGNOSTIC CHECK) that checks automatically the main instrument parameters. To run the program and check the analyzer functions, press the keys MENU >> Programs >> Diagnostic Checks (see "PROGRAMS DESCRIPTION" chapter).

*If the DIAGNOSTIC CHECK fails:*

Repeat it with new batteries after waiting the stabilization time (at least 1 minute) and, if the problem persists, contact the technical service.

### RESTORE OF FACTORY SETUP

The factory configuration of the analyzer parameters (factory setup) can be recalled through a key combination. **This operation does not cancel the content of the data memory.**

With the instrument switched off, turn on the HD2030 keeping the ENTER key pressed. All the parameters present in the menu are simultaneously set to the factory default.

### VARIOUS PROBLEMS

*If the CALIBRATION program with the calibrator fails:*

Make sure the analyzer is not subjected to noise and/or high vibrations.

Repeat after the waiting the stabilization time and, if the problem persists, contact the technical service.

*After changing the batteries, the instrument does not switch on.*

Remove one of the batteries and wait 5 minutes before inserting it again. The instrument should switch itself on automatically when the missing battery is inserted.

*The levels detected by the analyzer seem not corrected.*

- Make sure there is no condensation. Do not turn on the instrument if there is the probability of condensation.
- Wait for the measures stabilization time.
- Check the accuracy of the measurement with the calibrator.

*The analyzer switches itself off automatically after the startup screen.*

- The batteries are discharged.

*The instrument does not communicate with PC:*

- If you are using a communication program like HyperTerminal, check that the communication speed of the PC and HD2030 are the same (Menu >> Parameters >> Instrument >> Input/Output >> Baud rate).
- Check that the connection cable is correctly inserted and it is connected to a RS232 serial port or USB of PC
- Check that the item MENU>> Parameters >> Instrument >> Input/Output >> Serial Dev. is set to the port type in use: RS232 or USB.
- If using the USB interface, check if the driver is correctly installed.
- If you are using Noise Studio software, try to disable the Auto Detect function (Menu Option >> Port Settings) and set the connection directly to the COM where the instrument is connected.

*It is not possible to activate the continuous recording. Pressing REC and RUN keys the analyzer starts the measurement without recording.*

- The instrument has no available memory for further data. Download the data and/or erase the memory.

## KEYBOARD DESCRIPTION



### HOLD key

The HOLD key can be used to stop temporarily the display updating while the analyzer still continues with the requested measurements. A "H" in the upper left corner indicates that the display is in this mode. Press again the key to go back to the normal measure.

While the device is in HOLD, it is possible to switch from a screen to another, activate the cursors of the graphic screens, print and save the data.

The recording is not affected by the HOLD status.



### ON/OFF key

The instrument switching on and off can be done pressing, **for at least a second**, the ON/OFF key. At startup the analyzer briefly shows the Delta Ohm logo and the program version. Then it is requested to select the configuration for the sensors that are connected to the two inputs: first the triaxial right input and then the monoaxial left one.

CONFIG	RIGHT #02
PROD:	DELTA OHM
MOD:	ACC_TRI
S.N.:	123456
TYPE:	ACC TRI
SENS:	10mV/g CAL
RANGE:	500 gpk
SEL.	PREV. NEXT



For both inputs press **PREV** or **NEXT** to scroll the list of the sensors that are in memory, **SEL** to confirm the visualized configuration.

Then the instrument enters the VLM (Vibration Level Meter) working mode, visualizing in numerical form 3 instant or integrated parameters.

▶ Tint=10s 01:08:25
100 ██████████ 180
Ch1 1.539 g <sup>Fz</sup>
A1s 2.751 g
Aeq 7.930 g

If there is an external memory card, after the initial screen, the sensors configuration file is loaded and it appears the following screen:

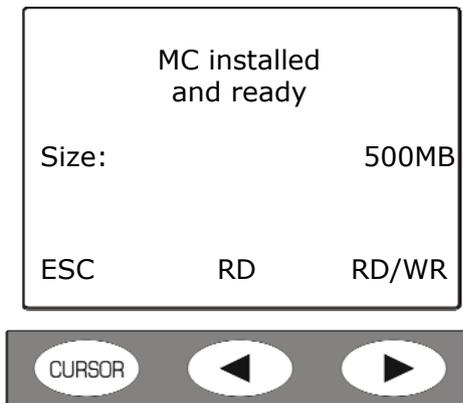

Press **RD/WR** to enable all the reading and writing functions and proceed with the selection of the configurations.

Before switching off the instrument, it is necessary to stop the current measurement pressing the STOP key. Otherwise a message requesting to stop the current measurement, appears:

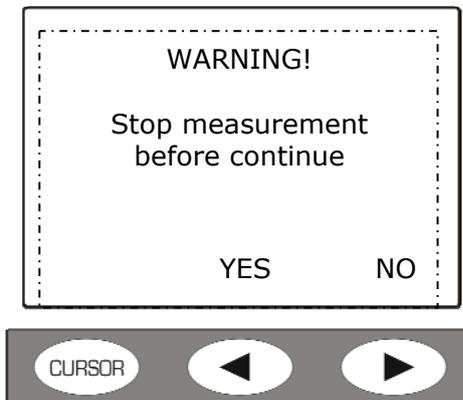

Pressing YES, the instrument enters the STOP mode and it is possible to switch it off with the ON/OFF button.

### "Auto-Power Off" Function

The Auto-Power Off function works if instrument remains in STOP mode for at least 5 minutes without pressing any key. Before switching itself off, a series of warning beeps are emitted: in this phase, if desired, it is possible to press a key to avoid the switching off.

The function can be disabled through the MENU acting on the "Auto-Switching Off" item (MENU >> Parameters>> Instrument >> System >> Auto-Power Off = OFF). In this case the battery symbol blinks to remind that the instrument will not switch itself off automatically but only pressing the <ON/OFF> key.

The auto-power off function is temporarily disabled when the external power supply is used, when the instrument is in acquisition mode or it is running a program.



### MENU Key

Pressing the MENU key, the two items **Settings** and **Programs** are accessed: the first contains all the instrument parameters that, depending on the use, can be modified by the user.

The second one contains some functions of frequent use; management of files in memory, setup, calibration, ...

The *Settings* menu includes the following items:

- Instrument
- Vibration analyzer
- Spectrum Analyzer
- Data Logger
- Calibration

The *Programs* menu includes the following items:

- Memory Navigator
- Setup Management
- Calibration
- Diagnostic Check
- Sensors Configuration
- Initialize Memory Card

In the menu and programs it is possible:

- To move from an item to another one in the same menu, using the UP and DOWN arrows,
- To select an item to modify, pressing the ENTER key,
- To modify the selected blinking parameter using the UP and DOWN arrows,
- To confirm the modification with the ENTER key or cancel the modification with the MENU key,
- To exit from the submenu or from the menu with the MENU key.

Some of the parameters available in the menu are also settable directly in measure mode (like for example the integration interval, the measurement range, etc.).

Entering the menu, it is possible to visualize the size of available memory, the remaining batteries charge, the date and the time.

A detailed description of the menu items is in the "MENU FUNCTIONS DESCRIPTION" AND "PROGRAMS DESCRIPTION" chapters.



### CHN Key

The CHN (Channel) key allows to select the measurement channel among the four available: CH1...CH3 refer to the triaxial right input, CH4 to the left monoaxial input.

The key works in all the screens.

From menu (MENU >> Parameters >> Instrument >> Measurement >> Ch1-4) it's possible to disable one or more measurement channels, that for example are not used: in order to enable all available channels, set menu parameter "Ch1-4" = 1111)

When one or more of CH1, CH2 or CH3 channels are disabled, measurements of "sum" vector or "maximum" vector are not displayed.



### MODE Key

The MODE key selects in sequence the different analyzer visualization modes, switching from VLM to *temporal profile*, to the *octave or third-octave spectra*, to the *probability distribution* and the *percentiles levels*.

All the working modes are simultaneously active even if they are not visualized: using the MODE key it is possible to choose the visualization mode without affecting the acquisition.

At startup, after the selection of the inputs configuration, the instrument displays the VLM screen.



### PAUSE/CONTINUE Key

The PAUSE key stops the calculation of the integrated measures (Leq, the maximum and minimum level, the spectra, etc.) and the eventual recording. The instant levels continues to be measured and visualized in the VLM screen. To start again the measurement, press again the PAUSE/CONTINUE key.

If in PAUSE mode, during a measurement session, the START/STOP/RESET key is pressed, the integrated parameters are reset.

If in PAUSE mode, during the review of a recording, the START/STOP/RESET key is pressed, the next memorized data is displayed.

If the START/STOP/RESET key is hold pressed, the fast review mode is entered.



### REC Key

If the REC key is pressed for at least 2 seconds, what it is visualized is saved in memory as single report.

The REC key together with the START/STOP/RESET key activates the continuous recording of the data in memory.

To memorize the time profile (both single and multi-profile), press at the same time the REC and START/STOP/RESET keys: the selection of the single or multiple mode depends on the settings of some parameters in menu. See the details in the "RECORDING MODE" chapter.



### START/STOP/RESET Key

Pressing the START key, starting from the STOP mode, reset the initial values of the integrated measures like Leq, MAX/MIN levels, etc. and starts a new execution.

Pressing the STOP key the next time, it is stopped the execution of the integrated measures.

**If pressed while in pause mode, all the integrated parameters are reset.**

In the review mode of the memorized data, if the START/STOP/RESET key is pressed while in pause mode, the next data is displayed; if hold pressed, the fast review mode is entered.



### UP arrow Key

The UP arrow key selects the previous row in the menu or increases the selected parameter.

In the VLM screen, it modifies the horizontal bar limits.

It decreases the vertical initial and full scale and of the time profile or frequency spectra moving in this way the graph up.



### LEFT arrow Key

In the menu, the LEFT arrow key moves the cursor on the left during the insertion of a character.

After the modification of a parameter of the menu, it goes back to the selection of the whole line in order to move among the various items.

It compresses (ZOOM-) the vertical scale of the time profile and frequency spectra.

In the VLM screens it changes the measure unit of the visualized parameters.

When the integration mode is multiple, the "Tint" symbol blinks: to go back to the single integration mode, select the "Tint=..." symbol with the ENTER key and press the LEFT arrow.



### ENTER Key

The ENTER key confirms the selected parameter. With the instrument in STOP mode, it allows the direct modification of the measurement parameters without entering the menu.

During the setting of the menu parameters, to exit from the setting mode of a parameter without saving it, press the MENU key.

Keeping ENTER pressed while switching on, the factory configuration of the parameters is loaded.



### RIGHT arrow Key

In the menu, the RIGHT arrow key moves the cursor on the right during the insertion of a character. It allows to modify the parameter of the menu in the selected line.

It extends (ZOOM+) the vertical scale of the time profile and frequency spectra.

In the VLM screens it changes the measure unit of the selected parameters.

It allows to select the multiple integration mode directly from the measurement screen, avoiding to access the menu. Press ENTER until the time value shown on side of "Tint=" blinks. Press the key "RIGHT arrow" key. The "Tint=" blinks to indicate that the multiple integration mode has been activated. To go back to single integration mode, press the "LEFT arrow" key.



### DOWN arrow Key

The DOWN arrow key selects the next row in the menu or decreases the selected parameter.

In the VLM screen, it changes the limits of the horizontal bar.

It increases the vertical initial and full scale of the time profile or frequency spectra moving, in this way, the graph down.

## CURSOR Key (keypad)

In a graphic mode, it activates the cursors. Pressing repeatedly the key, they are activated in sequence the first cursor (L1), the second cursor (L2) or both in "tracking" ( $\Delta L$ ): at the next pressing of the key, the cursors are disabled.

The selected blinking cursor is moved on the graphic with the LEFT and RIGHT arrows on the keypad.

In the upper part of the display the related values are displayed.

In **time profile**, they are indicated the level and the time or the difference of the level between the two cursors and the time distance.

In working mode as **spectrum analyzer**, they are visualized the level and the central frequency corresponding to the cursor selected band. The cursor can also select the wideband level placed on the right of the display.

When the function of the two cursors is not active, it is possible to switch from the visualization of the acceleration of each band to the **speed** or **displacement** visualization, pressing in sequence the left and right cursor keys.

Keeping the CURSOR key pressed, the limit acceleration curve is displayed.

To disable the limit acceleration curve, keep the CURSOR key pressed.

In the **probability distribution**, it is possible to read the probabilities in two points of the graph or, when they are both selected, to calculate the probability to have a value between two cursors.

In the **percentile levels** screen the cursor indicates the percentile level when the visualized parameter changes.

Keeping the CURSOR key pressed, while one of the **VLM** screens is displayed, it is possible to activate or deactivate the "beep" sound (activated each time a key is pressed).

Keeping the CURSOR key pressed, while one of the **VLM** screens is visualized, it is possible to activate or deactivate through the keyboard the backlit.



## LEFT Key (keypad)

The LEFT arrow key moves on the left the cursor or the two active cursors (blinking).

In **VLM** mode, it allows to scroll the VLM\_1, ..., VLM\_4 screens.

In working mode as **spectrum analyzer**, the left and right cursor keys allow to switch from acceleration to **speed** or **displacement** visualization.



## RIGHT arrow Key (Keypad)

The RIGHT arrow key moves on the right the cursor or the two active cursors (blinking).

In **VLM** mode, it allows to scroll the VLM\_1, ..., VLM\_4 screens.

In working mode as **spectrum analyzer**, the left and right cursor keys allow to switch from acceleration to **speed** or **displacement** visualization.

## APPENDIX

### A1. MEASURE PARAMETERS OF HD2030

In the following paragraphs are indicated the vibration levels with the related abbreviations used to identify them that can be visualized numerically or graphically and memorized.

#### LEVELS NUMERICALLY DISPLAYED

##### Frequency weightings

Application	Weight	DESCRIPTION
HA	<b>Fz</b>	Filter with a flat frequency response.
	<b>Fc</b>	Band-pass filter for hand-arm measurements 6.3Hz ÷ 1250Hz
	<b>Wh</b>	Filter for hand-arm measurements.
WB	<b>Fz</b>	Filter with a flat frequency response.
	<b>Fa</b>	Band-pass filter for measurements on the whole body: 0.4Hz ÷ 100Hz
	<b>Wb</b>	Filter for measures in the vertical axis (z), ISO 2631-4
	<b>Wc</b>	Filter for measures in horizontal axis from the back to the shoulders (x), back for a sitting person, ISO 2631-1
	<b>Wd</b>	Filter for measures on horizontal axis (x o y), ISO 2631-1
	<b>We</b>	Filter for rotational vibrations measures in all the directions Sitting person, ISO 2631-1
	<b>Wj</b>	Filter for measure of vibration at the top for vertical axis (x), lying person, ISO 2631-1
BV	<b>Wk</b>	Filter for measurements on vertical axis (z), ISO 2631-1
	<b>Fz</b>	Filter with a flat frequency response.
	<b>Fm</b>	Band-pass filter for building measurements: 0.8Hz ÷ 100Hz
	<b>Wm</b>	Filter for building measurements.

#### MEASURE PARAMETERS CALCULATED IN EACH CHANNEL

##### Instant values calculated every second

###### *Broadband*

PARAMETER	ABBREUV.	DEFINITION
aw,pk	<b>Pk</b>	Peak of weighted acceleration
aw,1s Linear Average	<b>AeqS</b>	Linear Average in 1 second of weighted acceleration
aw,1s Exponential Average	<b>A1s</b>	Exponential Average in 1 second of weighted acceleration
aw,8s Exponential Average	<b>A8s</b>	Exponential Average in 8 second of weighted acceleration
CF	<b>CF</b>	Crest Factor = aw,pk/aw,1s

## Integrated values in the measurement time

### Broadband

PARAMETER	ABBREV.	DEFINITION
Aw, pkmax	<b>Pkmx</b>	Maximum peak of weighted acceleration
aw, T Linear Average	<b>Aeq</b>	Linear Average in the measurement time of weighted acceleration
aw, 1s max Exponential Average	<b>A1smx</b>	Maximum exponential average in 1 second of weighted acceleration
aw, 1s min Exponential Average	<b>A1smn</b>	Minimum exponential average in 1 second of weighted acceleration
aw, 8s max Exponential Average	<b>A8smx</b>	Maximum exponential average in 8 second of weighted acceleration
aw, 8s min Exponential Average	<b>A8smn</b>	Minimum exponential average in 8 second of weighted acceleration
aw(eq, 1s)	<b>A(1s)</b>	Equivalent value of the frequency weighted acceleration in the measurement time referenced to 1 second (it is equivalent to SEL)
aw(eq, 8h)	<b>A(8)</b>	Equivalent value of the frequency weighted acceleration in the measurement time referenced to 8 hours
VDV	<b>VDV</b>	Vibration dose
VDV, 8h	<b>VDV, d</b>	Estimated daily vibration dose
MTVV	<b>MTVV</b>	Maximum Linear Average in 1second of the weighted acceleration
CF Linear Average	<b>CFeq</b>	Average Crest Factor = aw, pkmax/aw, T
Maximum CF	<b>CFmx</b>	Maximum Crest Factor = aw, pk/aw, 1s
VDV Ratio	<b>VDVr</b>	= $VDV/aw, T/T^{1/4}$ The limit value is equal to 1.75
MTVV Ratio	<b>MTVVr</b>	= $MTVV/aw, T$ The limit value is equal to 1.5
%OL	<b>OL</b>	Percentage of overload time
%UR	<b>UR</b>	Percentage of under-range time

## MEASURE PARAMETERS CALCULATED ON THE ACCELERATION VECTOR

### Instant values calculated every second

#### Broadband

PARAMETER	ABBREV.	DEFINITION
aw, pk	<b>Pk</b>	Peak of the weighted acceleration
aw, 1s Linear Average	<b>AeqS</b>	Linear Average in 1 second of weighted acceleration
aw, 1s Exponential Average	<b>A1s</b>	Exponential Average in 1 second of weighted acceleration
aw, 8s Exponential Average	<b>A8s</b>	Exponential Average in 8 seconds of weighted acceleration
CF	<b>CF</b>	Crest Factor = aw, pk/aw, 1s

## Integrated values in the measurement time

### *Broadband*

<b>PARAMETER</b>	<b>ABBREV.</b>	<b>DEFINITION</b>
Aw,pkmax	<b>Pkmx</b>	Maximum peak of weighted acceleration
aw, T Linear Average	<b>Aeq</b>	Linear average in the measurement time of weighted acceleration
aw,1s max Exponential Average	<b>A1smx</b>	Maximum Exponential Average in 1 second of the weighted acceleration
aw,1s min Exponential Average	<b>A1smn</b>	Minimum Exponential Average in 1 second of the weighted acceleration
aw,8s max Exponential Average	<b>A8smx</b>	Maximum Exponential Average in 8 seconds of the weighted acceleration
aw,8s min Exponential Average	<b>A8smn</b>	Minimum Exponential Average in 8 seconds of the weighted acceleration
aw(eq,1s)	<b>A(1s)</b>	Equivalent value of the frequency weighted acceleration in the measurement time referenced to 1 second (Equal to SEL)
aw(eq,8h)	<b>A(8)</b>	Equivalent value of the frequency weighted acceleration in the measurement time referenced to 8 hours
MTVV	<b>MTVV</b>	Maximum Linear Average in 1 second of the weighted acceleration
CF Linear Average	<b>CFeq</b>	Average crest factor = $aw,pkmax/aw,T$
Maximum CF	<b>CFmx</b>	Maximum crest factor = $aw,pk/aw,1s$
MTVV Ratio	<b>MTVVr</b>	$= MTVV/aw,T$ The limit value is equal to 1.5

## A2. MEMORY CAPACITY DURING THE RECORDING FUNCTION

The following table reports the indicative values of the storage capacity of the HD2030 analyzer in the different recording modes, expressed as the necessary time to fill the internal flash memory or as the number of recordings. The internal memory of the analyzer is 8MB.

Mode	Description	Memory capacity
Single recording and automatic storage	Only LEFT input. Spectral analysis by octave bands.	8500
	Only RIGHT input. Spectral analysis by octave bands.	3900
	LEFT+RIGHT inputs. Spectral analysis by octave bands.	2700
	Only LEFT input. Spectral analysis by third-octave bands	8100
	Only RIGHT input. Spectral analysis by third-octave bands	3300
	LEFT+RIGHT inputs. Spectral analysis by third-octave bands	2500
Profile recording Profile interval = 1s	Only LEFT input.	11 days
	Only RIGHT input.	7 days
	LEFT+RIGHT inputs.	6 days
Multiple profiles recordings. Single integration.	Only LEFT input. Spectral analysis by octave bands.	63 hours
	Only RIGHT input. Spectral analysis by octave bands.	22 hours
	LEFT+RIGHT inputs. Spectral analysis by octave bands.	17 hours
	Only LEFT input. Spectral analysis by third-octave bands	28 hours
	Only RIGHT input. Spectral analysis by third-octave bands	9 hours
	LEFT+RIGHT inputs. Spectral analysis by third-octave bands	7 hours
Multiple profiles recording. Multiple integration with integration interval = 10s	Only LEFT input. Spectral analysis by octave bands.	60 hours
	Only RIGHT input. Spectral analysis by octave bands.	20 hours
	LEFT+RIGHT inputs. Spectral analysis by octave bands.	15 hours
	Only LEFT input. Spectral analysis by third-octave bands	55 hours
	Only RIGHT input. Spectral analysis by third-octave bands	18 hours
	LEFT+RIGHT inputs. Spectral analysis by third-octave bands	14 hours

When a voice comment is memorized, about 16kB/s are necessary. The internal memory of the analyzer can contain at maximum 8 minutes of audio recording corresponding, for example, to more than 48 recordings with 10s commentaries.

For a comparison, in the following table are reported the indicative values of the storage capacity with a 1GB memory card.

<b>Mode</b>	<b>Description</b>	<b>Memory capacity</b>
Single recording and automatic storage	Only LEFT input. Spectral analysis by octave bands.	65000
	Only RIGHT input. Spectral analysis by octave bands.	65000
	LEFT+RIGHT inputs. Spectral analysis by octave bands.	65000
	Only LEFT input. Spectral analysis by third-octave bands	65000
	Only RIGHT input. Spectral analysis by third-octave bands	65000
	LEFT+RIGHT inputs. Spectral analysis by third-octave bands	65000
Profile recording. Profile interval = 1s	Only LEFT input.	1350 days
	Only RIGHT input.	910 days
	LEFT+RIGHT inputs.	780 days
Multiple profiles recording. Single integration.	Only LEFT input. Spectral analysis by octave bands.	314 days
	Only RIGHT input. Spectral analysis by octave bands.	110 days
	LEFT+RIGHT inputs. Spectral analysis by octave bands.	87 days
	Only LEFT input. Spectral analysis by third-octave bands	140 days
	Only RIGHT input. Spectral analysis by third-octave bands	48 days
	LEFT+RIGHT inputs. Spectral analysis by third-octave bands	37 days
Multiple profiles recordings. Multiple integration with integration interval= 10s	Only LEFT input. Spectral analysis by octave bands.	300 days
	Only RIGHT input. Spectral analysis by octave bands.	100 days
	LEFT+RIGHT inputs. Spectral analysis by octave bands.	77 days
	Only LEFT input. Spectral analysis by third-octave bands	275 days
	Only RIGHT input. Spectral analysis by third-octave bands	92 days
	LEFT+RIGHT inputs. Spectral analysis by third-octave bands	69 days

### A3. COMMUNICATION PROTOCOL

The commands are made by ASCII strings with variable length ending with CR-LF.

The instrument always gives an answer when it receives a command. If the command is not accepted, the answer string is always NAK-CR-LF. It is possible to deactivate the answer, when it is not explicitly requested by the command, acting on VERBOSE parameter (see PAR paragraph).

The commands are divided in 5 groups, as indicated in the following table.

Group	N. commands	Description
PAR	66	PARAM: Parameters Config.
KEY	18	KEY: Keyboard simulation
STT	3	STATUS: Analyzer Status
DMP	5	DUMP: Memory download
CNF	10	CONFIG: Sensor Config.

Each group contains a certain number of commands. Each command is identified by a specified string. The generic syntax of a command is the following:

<group>:<key>:<value>:CR-LF

e.g.: "PAR:INPUT\_GAIN:10\r\n"

Set the parameter INPUT\_GAIN to the value 10dB (see the paragraph SET).

Only capital characters are recognized. Each token can be shortened to the minimum number of characters that uniquely identifies it. The example can be shortened as follows:

"PAR:INP:10\r\n"

In the following the possible formats of the commands are reported.

- A3 - PAR:INT\_TIME:<{SS,MM,HH}>:<value>CRLF
- A4 - PAR:TIME:<hh>:<month>CRLF
- A5 - PAR:DATE:<year>:< month >:<day>CRLF
- A6 - PAR:x\_AXIS\_PARAMETER:<Parameter abbrev. >:<Parameter attribute>CRLF
- A7 - PAR:PROFILE\_PARAMETER:< Parameter abbrev. >:< Parameter attribute >CRLF
- A8 - PAR:<KEY>:<value>CRLF
- A10 - PAR:< KEY >:?CRLF
- C1 - KEY:< KEY >CRLF
- C2 - KEY:< KEY >:<value>CRLF
- D1 - STT:< KEY >:<OPTION>CRLF
- E1 - DMP:< KEY >CRLF
- F1 - CNF:<KEY >:<CHANNEL>:<#configuration>:<value or string>CRLF

Inserting appropriately the character "?" in the string, it is possible to get both help in order to fill the desired command and the current status of the instrument parameters. Following we reported the formats of the commands that use the "?" character.

- 0 ?CRLF It provides the list of the commands groups.
- A9 PAR:?CRLF It provides the PAR group list.
- A10 PAR:<KEY>:?CRLF It provides the current status of the parameter.
- C3 KEY:?CRLF It provides the KEY group list
- D2 STT:?CRLF It provides the STT group list
- D3 STT:<KEY>:?CRLF It provides the current status related to the specified command.
- E2 DMP:?CRLF It provides the DMP group list
- F2 CNF:?CRLF It provides the CNF group list
- F3 CNF:<KEY>:<CHANNEL>:<#configuration>:?CRLF It provides the current status of the configuration parameter.

## PAR GROUP (PARAMETERS)

The following table indicates the key list of PAR group

Key	Format	Description
INSTR_MODEL	A10	Instrument model – NOT CHANGEABLE
INSTR_NUMBER	A10	Instrument serial number - NOT CHANGEABLE
INSTR_VERSION	A10	Instrument version - NOT CHANGEABLE
RIGHT_CONFIG	A8	Configuration number of right channel (1÷9, 0 means that the channel is not active).
LEFT_CONFIG	A8	Configuration number of left input (1÷9, 0 means that the channel is not active).
RIGHT_TYPE	A10	Sensor type connected to the right input (ACC TRI for triaxial accelerometer or OFF).
RIGHT_MANUF	A10	Manufacturer of the sensor connected to the right channel.
RIGHT_MODEL	A10	Model of the sensor connected to the right channel.
RIGHT_NUMBER	A10	Serial number of the sensor connected to the right channel.
RIGHT_SENS	A8	Nominal sensitivity of the sensor connected to the right channel.
LEFT_TYPE	A10	Type of sensor connected to the left channel (ACC MON for monoaxial accelerometer or OFF).
LEFT_MANUF	A10	Manufacturer of the sensor connected to the left channel.
LEFT_MODEL	A10	Model of the sensor connected to the left channel.
LEFT_NUMBER	A10	Serial number of the sensor connected to the left channel.
LEFT_SENS	A8	Nominal sensitivity of the sensor connected to the left channel.
MEM_SIZE	A10	Memory size – NOT CHANGEABLE
OPTIONS	A10	Firmware options – NOT CHANGEABLE
TIME	A4	Time (hh:mm)
DATE	A5	Date (yyyy/mm/dd)
VERBOSE	A8	Answer mode to the commands (default ON).
VPOL_1	A8	Polarization voltage of n.1 axis related to the sensor connected to the right channel. – Parameter available only for reading.
VPOL_2	A8	Polarization voltage of n.2 axis related to the sensor connected to the right channel. Parameter available only for reading.
VPOL_3	A8	Polarization voltage of n.3 axis related to the sensor connected to the right channel. Parameter available only for reading.
VPOL_4	A8	Polarization voltage of left sensor related to the sensor connected to the right channel. Parameter available only for reading.
BATTERY TYPE	A8	ALKALINE (default) or NiMH Battery Type
BACKLIGHT	A8	Backlight Display (ON/OFF, default:ON)
DISP_CONTRAST	A8	Display Contrast (3÷9, default: 5)
AUTO_POWEROFF	A8	Instrument Auto off (ON/OFF, default: OFF)
PROT_CODE	A10	Protection code. Changeable with password.
PRINT_OUT	A8	Results printing (ON/OFF, default: OFF)
PRINT_MODE	A8	Printing results type (VLM, SPC o VLM+SPC)
TRG_OUTPUT	A8	TRGOUT output (ON/OFF, default: OFF)
TRG_OUT_POLARITY	A8	Polarity TRGOUT output (POS/NEG)
BAUD_RATE	A8	Baud rate RS232 port
MEM_TYPE	A8	Memory type for data logging (FLASH/CARD)
DEVICE	A8	Serial device (RS232/USB)

Key	Format	Description
VIB_MODE	A8	Vibrometer Application (HA/WB/BV)
INPUT_GAIN	A8	Input amplification (0/10/20)
INT_DELAY	A8	Integration delay (1÷99)
INT_MODE	A8	Integration mode (SING/MULT)
PROFILE_TIME	A8	Profile time
INTEGRATION_TIME	A3	Integration time in s, m (1÷59) or h (1÷99)
MEAS_UNIT	A8	Measure unit
POND_1	A8	Axis 1 weight for the calculation of the vector
POND_2	A8	Axis 2 weight for the calculation of the vector
POND_3	A8	Axis 3 weight for the calculation of the vector
COEFF_1	A8	Axis 1 coefficient for the calculation of the vector
COEFF_2	A8	Axis 2 coefficient for the calculation of the vector
COEFF_3	A8	Axis 3 coefficient for the calculation of the vector
HIGH_PASS	A8	Activation high-pass filter 0.6Hz
1_AXIS_PARAMETER	A6	Parameter 1 single axis (see parameter list)
2_AXIS_PARAMETER	A6	Parameter 2 single axis (see parameter list)
3_AXIS_PARAMETER	A6	Parameter 3 single axis (see parameter list)
1_VEC_PARAMETER	A6	Parameter 1 vector (see parameter list)
2_VEC_PARAMETER	A6	Parameter 2 vector (see parameter list)
3_VEC_PARAMETER	A6	Parameter 3 vector (see parameter list)
PROFILE_PARAMETER	A7	Profile parameter (see parameter list)
SPECT_AUX_POND	A8	Auxiliary spectrum weighting
SPECT_TYPE	A8	Spectrum Type (AVR/MLT)
SPECT_ORDER	A8	Spectrum Order: octave (1/1), or third-octave (1/3).
SPECT_INTEGRATION	A8	Spectrum integration: none (OFF), single (X1) or double (X2).
1_MARKER	A10	Marker n.1 identification
2_MARKER	A10	Marker n.2 identification
3_MARKER	A10	Marker n.3 identification
4_MARKER	A10	Marker n.4 identification
5_MARKER	A10	Marker n.5 identification
6_MARKER	A10	Marker n.6 identification
7_MARKER	A10	Marker n.7 identification
8_MARKER	A10	Marker n.8 identification
9_MARKER	A10	Marker n.9 identification
DLOG_TYPE	A8	Data logging type (PROFILE/FULL)
DLOG_ADC_SAMPLES	A8	It activates the ADC samples recording: at choice axis 1,2,3 or 4 or the combinations 123 and 1234.
1G_AXIS_PARAMETER	A6	Global parameter 1 single axis (see parameter list)
2G_AXIS_PARAMETER	A6	Global parameter 2 single axis (see parameter list)
3G_AXIS_PARAMETER	A6	Global parameter 3 single axis (see parameter list)
1G_VEC_PARAMETER	A6	Global parameter 1 vector (see parameter list)
2G_VEC_PARAMETER	A6	Global parameter 2 vector (see parameter list)
3G_VEC_PARAMETER	A6	Global parameter 3 vector (see parameter list)
DLOG_AUTO_STORE	A8	It activates the Auto-Store function (ON/OFF, default: OFF)
CAL_LEVEL	A8	Calibration level in m/s <sup>2</sup> (0.1 ÷ 300, default: 10.0)

The value that some of the parameters can assume is indicated in the following table (the default value is bolded).

<b>Parameter</b>	<b>Value</b>
BATT_TYPE	<b>ALKALINE</b>
	NiMH
PRINT_MODE	<b>VLM</b>
	SPC
	VLM+SPC
TRG_OUT_POLARITY	<b>POS</b>
	NEG
BAUD_RATE	300
	600
	1.2k
	2.4k
	4.8k
	9.6k
	19.2k
	38.4k
	57.6k
	<b>115.2k</b>
MEM_TYPE	<b>FLASH</b>
	CARD
DEVICE	<b>RS232</b>
	USB
VIB_MODE	<b>HA</b>
	WB
	BV
INPUT_GAIN	<b>0</b>
	10
	20
INT_MODE	<b>SING</b>
	MULT
MEAS_UNIT	<b>dB</b>
	m/s <sup>2</sup>
	cm/s <sup>2</sup>
	ft/s <sup>2</sup>
	in/s <sup>2</sup>
SPECT_TYPE	<b>AVR</b>
	MLT
SPECT_ORDER	1/1
	<b>1/3</b>
SPECT_INTEGRATION	<b>OFF</b>
	X1
	X2
DLOG_TYPE	<b>PROFILE</b>
	FULL
DLOG_ADC_SAMPLES	<b>OFF</b>
	1
	2
	3
	4
	123
1234	

## KEY GROUP

The following table indicates the commands list of KEY group

Command	Format	Description
OFF	C1	It switches off the instrument
HOLD	C1	HOLD key
MENU	C1	MENU key
CHN	C1	CHN key
MODE	C1	MODE key
PAUSE	C1	PAUSE/CONTINUE key
STORE	C1	It simulates the pressure for more than 2 seconds of the REC key
START	C1	START/STOP key
UP	C1	UP arrow key
DOWN	C1	DOWN arrow key
RIGHT	C1	RIGHT arrow key
LEFT	C1	LEFT arrow key
ENTER	C1	ENTER key
CURSOR	C1	CURSOR key
CLEFT	C1	LEFT CURSOR arrow key
CRIGHT	C1	RIGHT CURSOR arrow key
DATA_LOG	C1	REC+START key
PRN_VAL	C1	It sends to the serial interface the visualized levels
EXEC	C2	Execution of programs

## STT (STATUS) GROUP

The following table indicates the commands list of STT (STATUS) group.

Command	Description
ACQUISITION	Acquisition control
DISPLAY	Display management
SETUP	Setup management

In the following table are indicated the commands of the ACQUISITION subgroup that can be activated with the string: ACQUISITION:<key>.

Command	Format	Description
HOLD	D1	It stops the updating of the display
UPDATE	D1	It activates the display updating
PAUSE	D1	It pause the measurement
RUN	D1	It starts the measurements
STOP	D1	It ends the measurements
CLEAR	D1	It resets the measured levels
CONTINUE	D1	It starts again to measure

The command STT:ACQUISITION:? gives the information about the acquisition status as indicated in the following example.

```
STT:ACQ:?  
STT:ACQUISITION:STOP  
BATTERY: 32%  
MEMORY: 95.4%  
DUMP TIME:00:00:01  
TEMP. CORR.: 0.01dB  
LAST CALIBRATION: 2003/07/31 08:37
```

In the following table are indicated the commands of the DISPLAY subgroup that can be activated with STT:DISPLAY:<key> string.

Command	Format	Description
VLM_AXIS	D1	It visualizes the VLM screen related to a single axis
VLM_VECTOR	D1	It visualizes the VLM screen related to the vector
PROFILE	D1	It visualizes the PROFILE screen
OCTAVE	D1	It visualizes the SPECTRUM screen
PROB_DISTR	D1	It visualizes the STATISTIC screen
CUMUL_DISTR	D1	It visualizes the PERCENTILES screen

STT:DISPLAY:? command gives information about what it is currently visualized on the vibrations analyzer display as indicated in the following example.

```
STT:DIS:?  
STT:DISPLAY:Mode:PROFILE
```

In the following table are indicated the commands of the SETUP subgroup.

Command	Format	Description
LOAD	D2	It loads the specified setup
STORE	D2	It memorizes the specified setup

The syntax of the setup reading command is:  
 STT:SETUP:LOAD:<# setup>  
 The specified setup is loaded into the instrument.

The syntax of the setup storage command is:  
 STT:SETUP:STORE:<# setup>:<title (max 21 characters)>  
 The current setup is memorized, with title, in the specified position.  
 The setup number must be chosen in the interval 1÷10.

## DMP (DUMP) GROUP

The following table indicates the commands list of the DMP (DUMP) group.

Command	Format	Description
ON	E1	It starts the download of the memory.
OFF	E1	It stops the download of the memory.
NEXT_RECORD	E1	It asks for the transmission of the next record.
RECORD	E1	It asks for the transmission of the current record.
CLEAR	E1	It cancel the memory

The download of the data memorized in the FLASH memory of the instrument is performed with following the commands sequence:

- DMP:ON\r\n  
 If there are data in memory, it is printed the header that ends with the "MEMORY DUMP\r\n" string
- DMP:RECORD\r\n  
 It prints in binary format the previous record
- DMP:NEXT\_RECORD\r\n  
 It downloads in binary format a block of 512 bytes (followed by checksum). If there are no other data in memory, the string "END OF DUMP\r\n" is printed.
- DMP:CLEAR\r\n (optional)  
 It resets the content of the FLASH memory
- DMP:OFF\r\n  
 It stops the data download.

In case of a fault during the transmission of the block (checksum fault) it is possible to request to transmit again the same block with the command:

- DMP:RECORD\r\n  
 It prints in binary format the current record

The data download can be stopped at any time with the command:

- DMP:OFF\r\n  
 It stops the data download.

## CNF (CONFIGURE) GROUP

The following table indicates the command list of the CNF (CONFIGURE) group.

Key	Format	Description
PROD	F1	Sensor Manufacturer
MODL	F1	Model
MATR	F1	Serial Number
TIPO	F1	Sensor Type
INDX	F1	Index of nominal sensitivity
RANG	F1	Maximum level measurable
STOR	F1	Storage of the configuration

A sensor configuration is performed with the following commands sequence:

- CNF:PROD:<CHANNEL>:<#configuration>:<manufacturer (max 10 characters)>\r\n  
Set the sensor manufacturer
- CNF:MODL:<CHANNEL>:<#configuration >:<model (max 10 characters)>\r\n  
Set the sensor model.
- CNF:MATR:<CANALE>:<#configuration>:<serial number (max 10 characters)>\r\n  
Set the serial number of the sensor
- CNF:TIPO:<CANALE>:<#configuration>:<code type>\r\n  
Set the sensor type according to the numerical code indicated in the following table.

Code	Description
0	No sensor
64	Monoaxial accelerometer.
96	Triaxial accelerometer.

The right channel can use only triaxial accelerometers while the left channel can use only monoaxial accelerometers.

- CNF:INDX:<CHANNEL>:<#configuration>:<sensitivity index >\r\n
- Set the sensitivity nominal index of the sensor according to the numeric code indicated in the following table:

Code	Nominal sensitivity	Sensitivity interval
	[mV/g]	
0	1	0 ÷ 1.5
1	2	1 ÷ 3
2	5	2.5 ÷ 7.5
3	10	5 ÷ 15
4	20	10 ÷ 30
5	50	25 ÷ 75
6	100	50 ÷ 150
7	200	100 ÷ 300
8	500	250 ÷ 750
9	1000	500 ÷ 1500

The code to insert is the one related to the sensitivity interval more adequate to the sensor.

- CNF:RANG:<CHANNEL>:<#configuration>:<level>\r\n  
Set the maximum level of acceleration measurable by the sensor (in g).
- CNF:STOR\r\n  
Permanently memorize the modifications made to the table of the sensors configuration. After the execution of this command, it is necessary proceed with the calibration of the inserted or modified sensors.  
The CHANNEL code is R for the right channel and L for the left one. The configuration number is chosen in the interval 1 ÷ 9.

#### A4. WEIGHTING FILTERS

Frequency responses of the weighting filters are reported hereafter: for each filter are shown  $W_x$  (curve 2) responses and corresponding band-pass filter  $F_x$  (curve 1) including the tolerances allowed by the technical standard.

##### Weighting filter $W_b$

Filter for whole body vertical acceleration measurement (axis Z) for seating, standing or supine persons (ISO 2631-4)

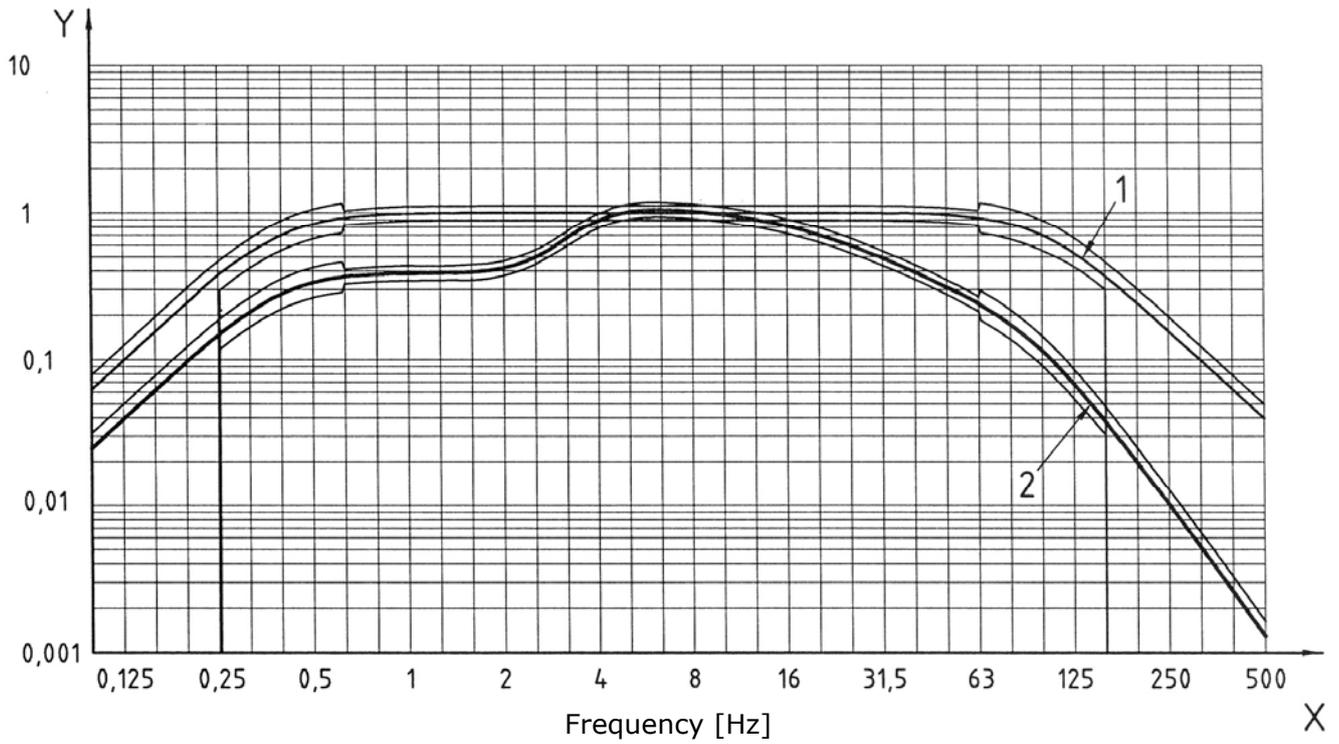

### Weighting filter Wc

Filter for whole body horizontal acceleration measurement (X axis) transmitted from seat back to seated persons (ISO 2631-1)

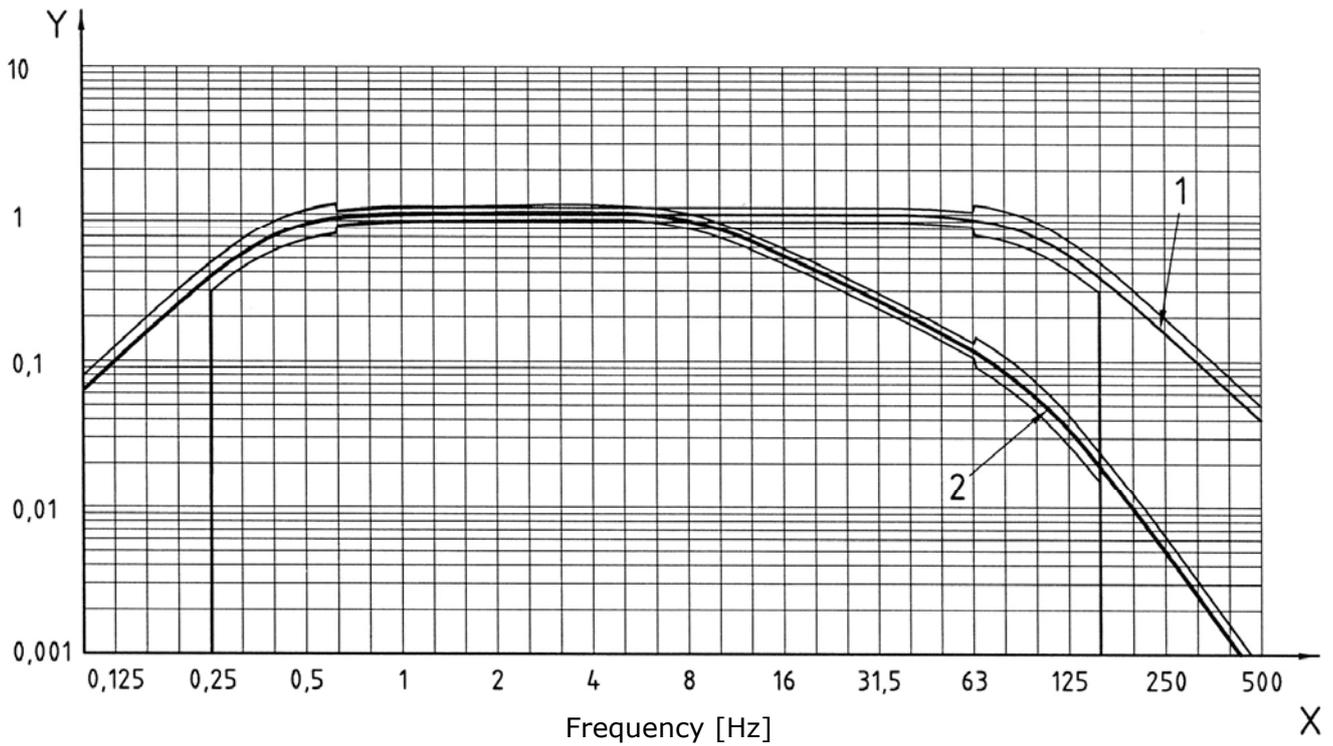

### Weighting filter Wd

Filter for horizontal whole body acceleration measurement (X or Y axes) for seated, standing or supine persons (ISO 2631-1)

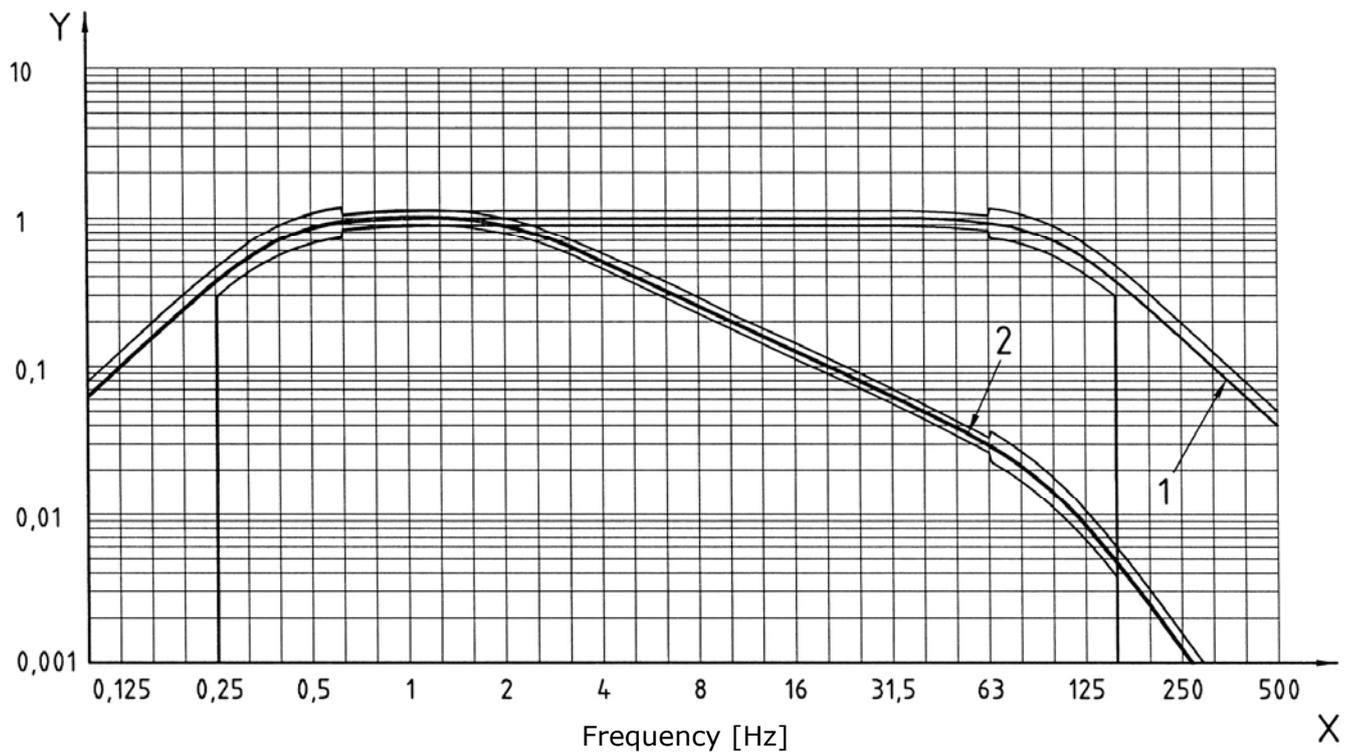

**Weighting filter We**

Filter for angular whole body acceleration measurement (all directions) for seated persons (ISO 2631-1)

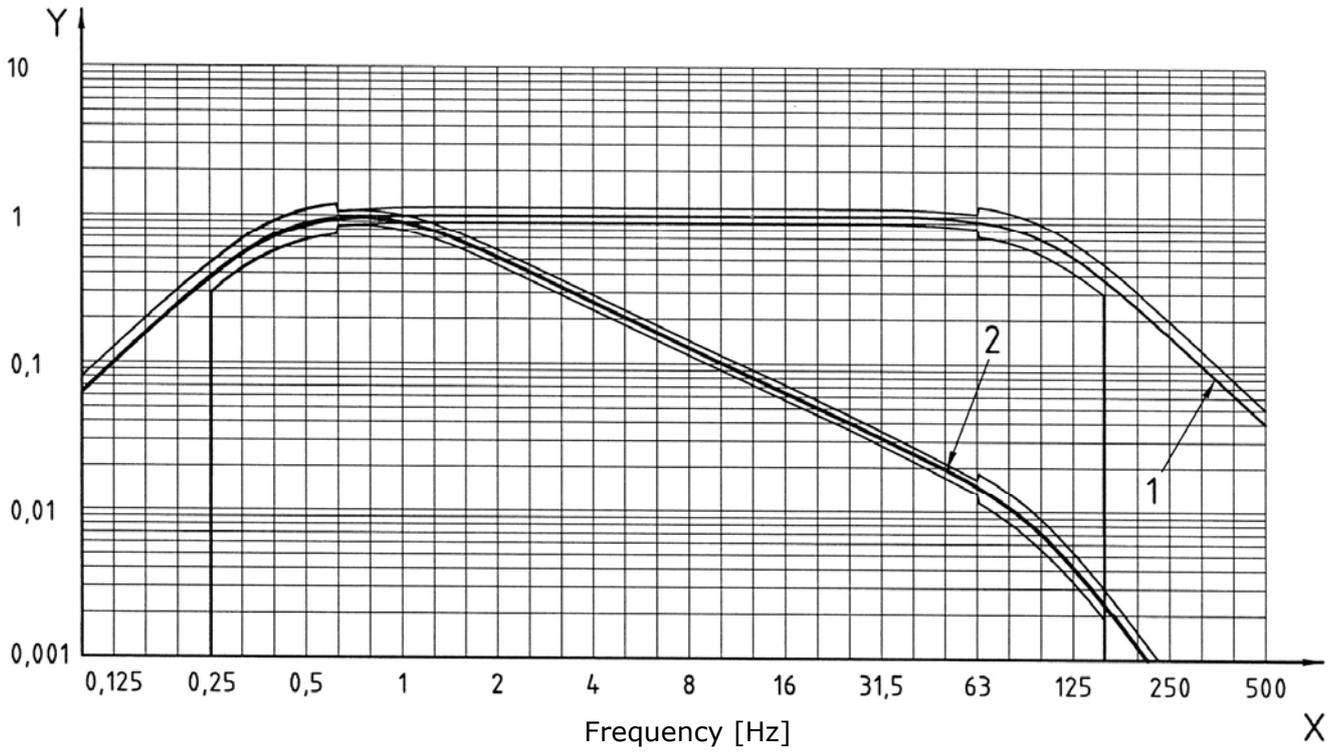

**Weighting filter Wh**

Filter for hand-arm system transmitted vibration measurement (all directions) (ISO 5349-1)

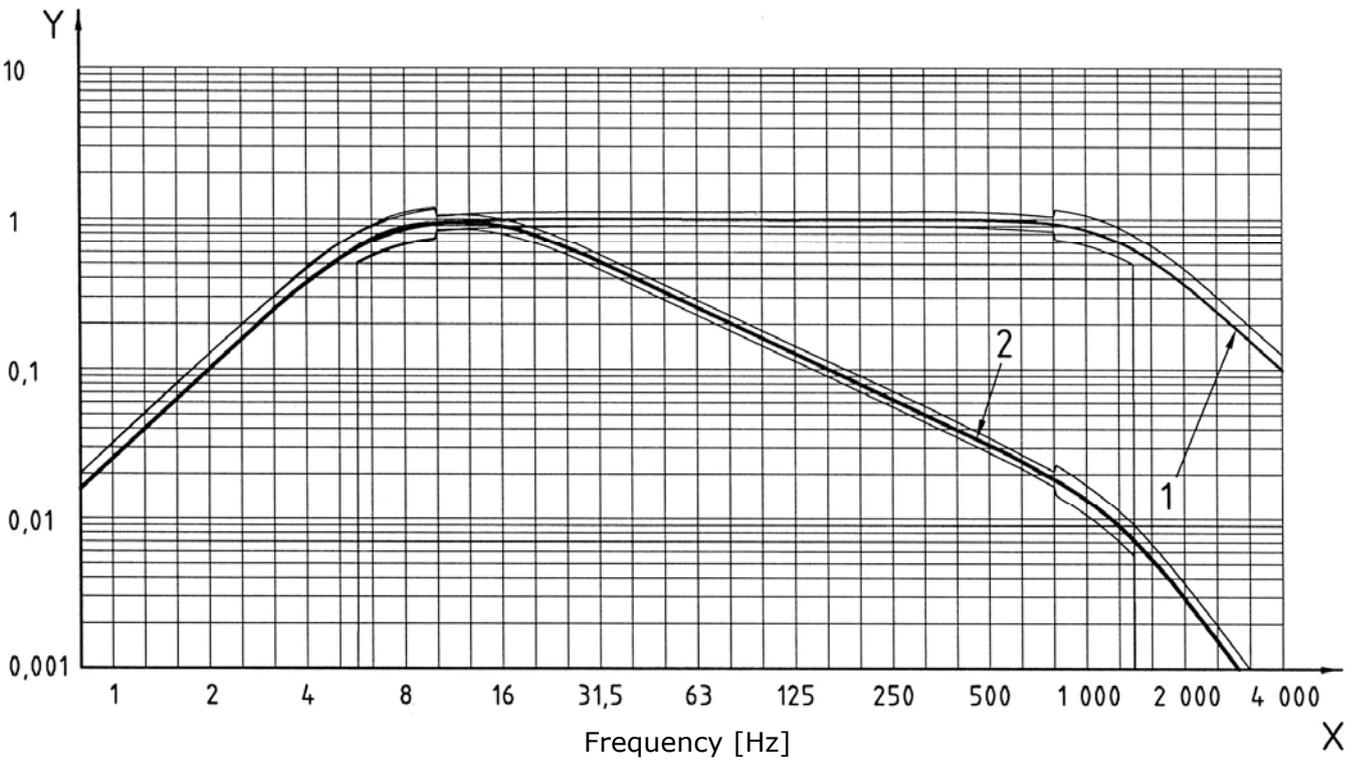

**Weighting filter  $W_j$**

Filter for head vertical acceleration measurement (X axis) for supine persons (ISO 2631-1)

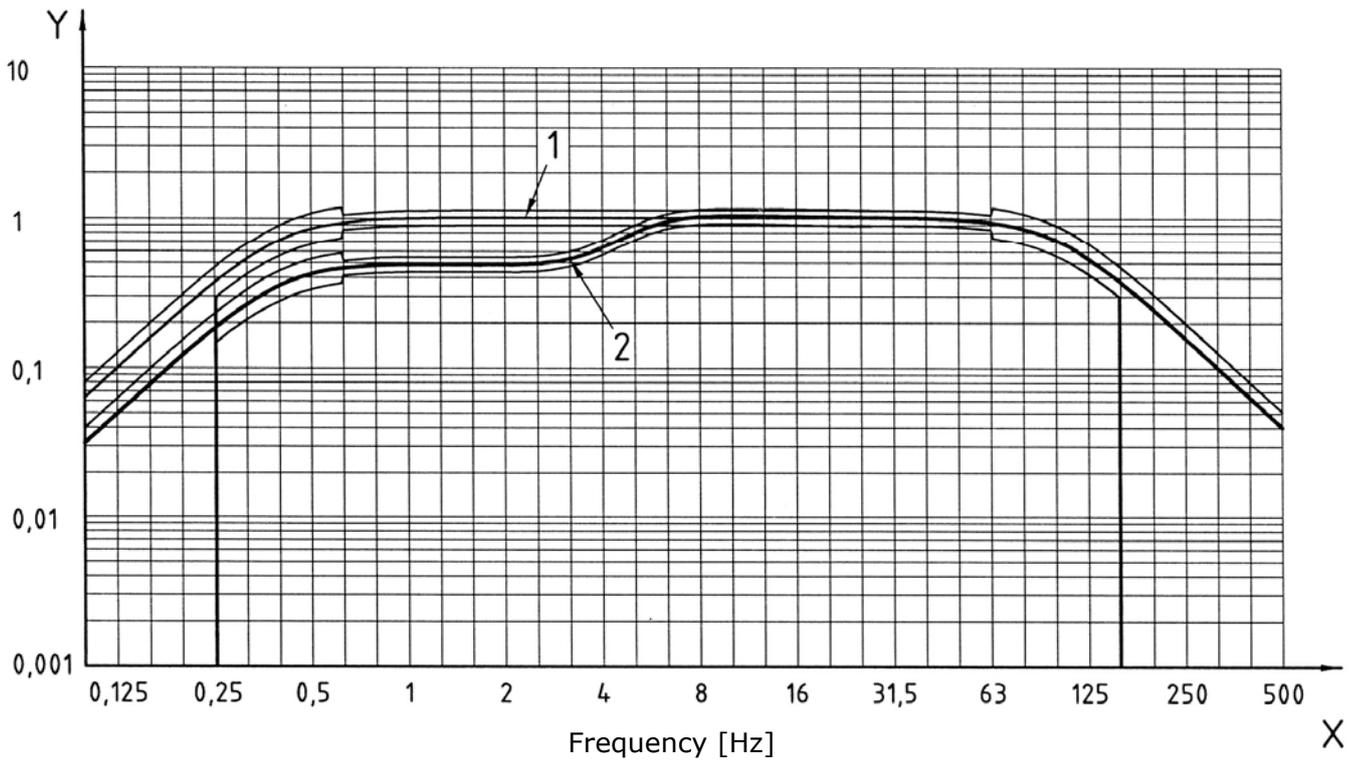

**Weighting filter  $W_k$**

Filter for whole body vertical vibration measurement (Z axis) for seated, standing or supine persons (ISO 2631-1)

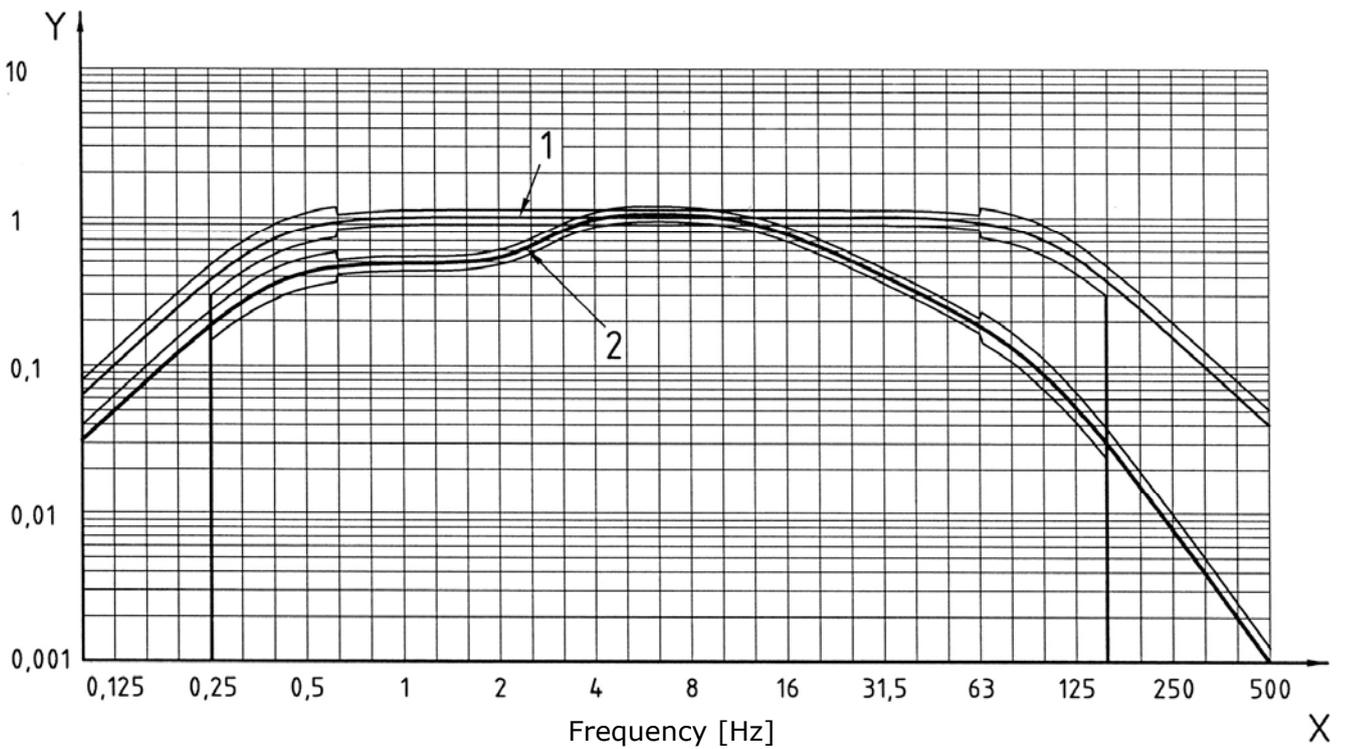

### Weighting filter $W_m$

Filter for building transmitted acceleration on persons (all directions) (ISO 2631-2)

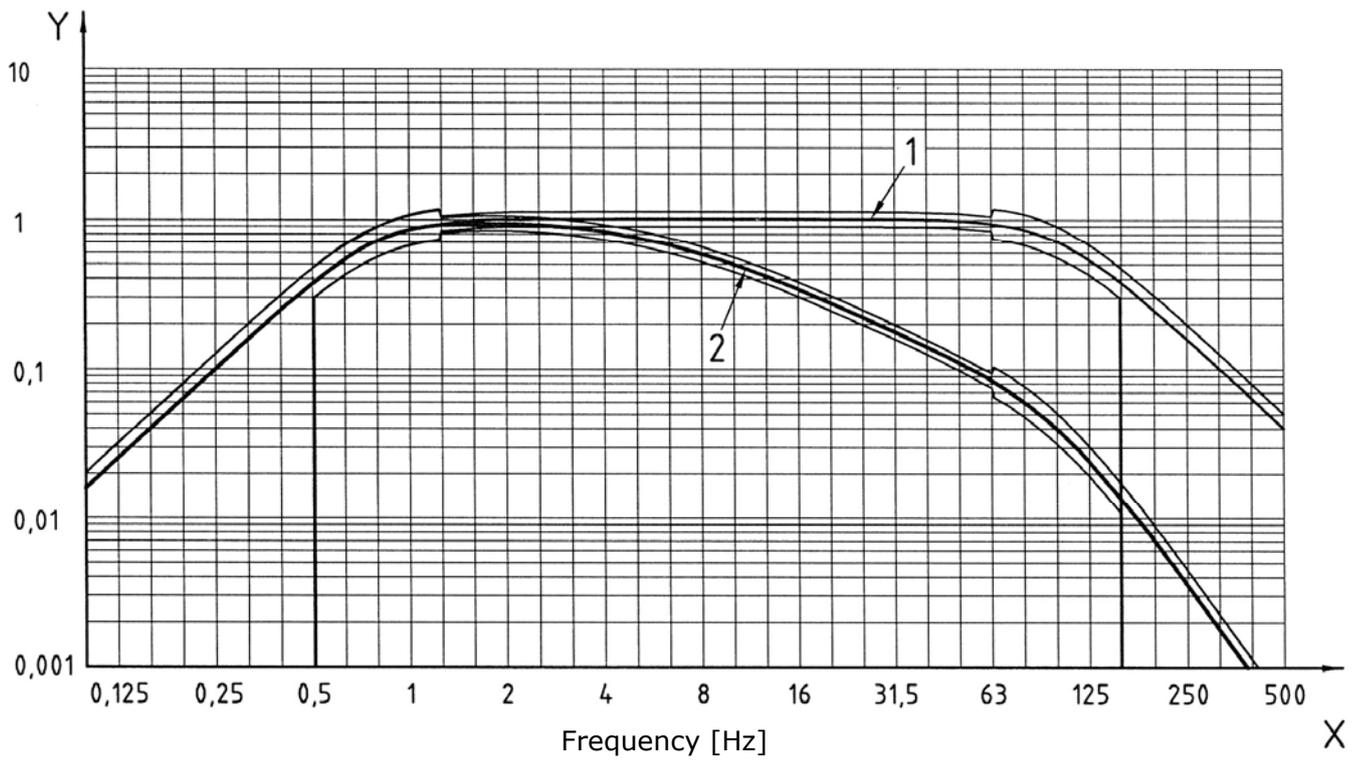

## NOTES ABOUT THE OPERATION AND USER SAFETY

### Authorized use

Observe the technical specifications indicated in the chapter "TECHNICAL FEATURES". It is authorized only the use in compliance with the instructions indicated in this manual. Any other use is to be considered not authorized.

### General safety instructions

This instrument was built and checked in compliance with the EN 61010-1 safety rules for the electronic measurement instruments and left the factory in perfect technical safety conditions.

The regular functioning and the operational safety of the instrument can be warranted only if are observed all the normal safety measures as well as the specifications described in this manual.

The regular functioning and the operational safety of the instrument can be warranted only at temperature condition specified in "TECHNICAL FEATURES" chapter.

Do not use or store the instrument in ways and/or places where there are:

- Quick changes in temperature that could cause condense formation.
- Corrosive or flammable gas.
- Direct vibrations or instrument shocks.
- High intensity electromagnetic fields, static electricity.

If the product is transported from a cold to a warm place, the formation of condense can disturbs its operation. In this case it must be waited until the temperature of the instrument reaches the room temperature before putting it in operation.

### User obligations

The user of the instrument must ensure the observation of the following rules and directives on the treatment of hazardous materials:

- EC directives for safety at work
- national legal standards for safety at work
- prevention regulations

# SUMMARY

<b>CONNECTORS AND KEYBOARD .....</b>	<b>3</b>
<b>INSTRUMENT OVERVIEW.....</b>	<b>5</b>
<i>BLOCK DIAGRAM OF HD2030 .....</i>	<i>5</i>
<i>MEASURE CHANNELS .....</i>	<i>5</i>
<i>THE INSTRUMENT .....</i>	<i>5</i>
<i>HOW TO CONNECT THE ACCELEROMETERS TO THE ANALYZER .....</i>	<i>6</i>
<b>INTRODUCTION.....</b>	<b>7</b>
<b>DESCRIPTION OF DISPLAY MODES.....</b>	<b>9</b>
VLM SCREEN .....	12
PROFILE SCREEN .....	14
SPECTRUM SCREEN .....	15
DISTRIBUTION OF PROBABILITY SCREEN .....	17
PERCENTILES SCREEN .....	18
<b>APPLICATIONS.....</b>	<b>19</b>
HAND ARM.....	19
WHOLE BODY.....	22
BUILDING VIBRATION.....	23
<b>MEASUREMENT MODES.....</b>	<b>24</b>
SINGLE INTEGRATION .....	24
MULTIPLE INTEGRATION .....	24
<b>USE OF THE EXTERNAL MEMORY CARD.....</b>	<b>25</b>
<b>RECORDING MODES.....</b>	<b>27</b>
SINGLE RECORD.....	28
SINGLE PROFILE.....	28
MULTI PROFILE .....	29
RECORDING OF VOICE COMMENTS.....	31
<b>PROGRAMS DESCRIPTION .....</b>	<b>33</b>
MEMORY NAVIGATOR PROGRAM .....	33
SETUP MANAGEMENT PROGRAM .....	43
CALIBRATION PROGRAM .....	46
DIAGNOSTIC CHECK PROGRAM .....	51
SENSORS CONFIGURATION PROGRAM .....	53
MC INITIALIZATION PROGRAM .....	54
<b>DESCRIPTION OF THE MENU FUNCTIONS.....</b>	<b>56</b>
INSTRUMENT .....	58
<i>IDENTIFICATION.....</i>	<i>58</i>
<i>SYSTEM .....</i>	<i>58</i>
<i>INPUT/OUTPUT.....</i>	<i>59</i>
<i>MEASUREMENTS.....</i>	<i>60</i>
VIBRATION ANALYSER .....	61
SPECTRUM ANALYZER.....	61
DATA LOGGER.....	61
<i>PROFILES .....</i>	<i>62</i>
<i>GLOBAL .....</i>	<i>62</i>
CALIBRATION .....	62
<b>FIRMWARE UPDATE.....</b>	<b>63</b>
<b>REPORTING OF LOW BATTERIES AND REPLACEMENT OF THE BATTERIES.....</b>	<b>64</b>
<b>INSTRUMENT STORAGE.....</b>	<b>65</b>

<b>SERIAL INTERFACE.....</b>	<b>66</b>
<b>MEASURE PARAMETERS.....</b>	<b>68</b>
<b>DIRECT PRINTER CONNECTION.....</b>	<b>78</b>
<b>CONNECTION TO A PC WITH USB INTERFACE.....</b>	<b>79</b>
<i>INSTALLATION NOTES.....</i>	<i>80</i>
<i>VERIFICATION OF PROPER DRIVER INSTALLATION.....</i>	<i>80</i>
<b>CONNECTORS DESCRIPTION.....</b>	<b>82</b>
<b>TECHNICAL SPECIFICATIONS.....</b>	<b>85</b>
METROLOGICAL SPECIFICATIONS.....	86
ELECTRICAL FEATURES.....	88
STATISTICAL ANALYSIS.....	90
SPECTRAL ANALYSIS.....	90
VISUALIZATION.....	90
MEASUREMENTS STORAGE.....	90
OTHER FEATURES.....	91
ACCELEROMETERS TECHNICAL SPECIFICATIONS.....	92
<b>REFERENCE STANDARDS.....</b>	<b>99</b>
EMC STANDARDS.....	99
ITALIAN STANDARDS.....	99
<b>ORDER CODES.....</b>	<b>100</b>
<b>HOW TO SOLVE THE PROBLEMS.....</b>	<b>108</b>
RESTORE OF FACTORY SETUP.....	108
VARIOUS PROBLEMS.....	108
<b>KEYBOARD DESCRIPTION.....</b>	<b>109</b>
<b>APPENDIX.....</b>	<b>115</b>
A1. MEASURE PARAMETERS OF HD2030.....	115
<i>LEVELS NUMERICALLY DISPLAYED.....</i>	<i>115</i>
A2. MEMORY CAPACITY DURING THE RECORDING FUNCTION.....	118
A3. COMMUNICATION PROTOCOL.....	120
<i>PAR GROUP (PARAMETERS).....</i>	<i>121</i>
<i>KEY GROUP.....</i>	<i>124</i>
<i>STT (STATUS) GROUP.....</i>	<i>125</i>
<i>DMP (DUMP) GROUP.....</i>	<i>126</i>
<i>CNF (CONFIGURE) GROUP.....</i>	<i>126</i>
A4. WEIGHTING FILTERS.....	128
<b>NOTES ABOUT THE OPERATION AND USER SAFETY.....</b>	<b>133</b>

# GUARANTEE



## GUARANTEE CONDITIONS

All DELTA OHM instruments have been subjected to strict tests and are guaranteed for 24 months from date of purchase. DELTA OHM will repair or replace free of charge any parts which it considers to be inefficient within the guarantee period. Complete replacement is excluded and no request of damages are recognized. The guarantee does not include accidental breakages due to transport, neglect, incorrect use, incorrect connection to voltage different from the contemplated for the instrument. Furthermore the guarantee is not valid if the instrument has been repaired or tampered by unauthorized third parties. The instrument has to be sent to the retailer without transport charge. For all disputes the competent court is the Court of Padua.



The electric and electronic devices with the following symbol cannot be disposed in the public dumps. According to the Directive UE 2002/96/EC, the European users of electric and electronic devices are allowed to give back to the Distributor or Manufacturer the used device at the time of purchasing a new one. The illegal disposing of electric and electronic devices is punished by a pecuniary administrative penalty.

This guarantee must be sent together with the instrument to our service centre.

N.B.: Guarantee is valid only if coupon has been correctly filled in all details.

**Instrument type**       **HD 2030**

**Serial number**      \_\_\_\_\_

## RENEWALS

Date \_\_\_\_\_ Date \_\_\_\_\_

Inspector \_\_\_\_\_ Inspector \_\_\_\_\_

Date \_\_\_\_\_ Date \_\_\_\_\_

Inspector \_\_\_\_\_ Inspector \_\_\_\_\_

Date \_\_\_\_\_ Date \_\_\_\_\_

Inspector \_\_\_\_\_ Inspector \_\_\_\_\_



CE CONFORMITY	
Safety	EN61010-1
Electromagnetic compatibility. Immunity general standard	EN61000-6-2:2005
Electromagnetic compatibility. Emission general standard	EN61000-6-3:2007
Electrostatic Discharge Immunity	EN61000-4-2 level 3
Susceptibility to electromagnetic interference	EN61000-4-3 level 3
Immunity to electrical fast transients	EN61000-4-4 level 3
Immunity to conducted disturbances	EN61000-4-6
Electromagnetic Interference - Conducted Emissions	EN55022:2007 class B
Electromagnetic Interference - Irradiated Emissions	IEC/CISPR 22 class B