

LP UVI 02

▶ [GB] Radiometer UV INDEX



[GB] Description

The radiometer LP UVI 02 measures the global effective irradiance on a flat surface (Watt / m2 effective), according to the requirements of the WMO for the measurement of UV-index. The global irradiance is the sum of direct sun and of diffuse irradiance. In the ultraviolet spectral region, unlike what occurs in the portion of the visible light where the direct component is prevalent on the diffuse component, the light is strongly scattered in the atmosphere, and then the two components are equal; it is therefore of primary importance that the radiometer is able to accurately measure both components.

The radiometer LP UVI 02 is produced with current output or voltage output:
 LP UVI 02 AC is a current loop transmitter (4÷20mA) with measuring range 0÷16 UV-index,
 LP UVI 02.1 AC is a current loop transmitter (4÷20mA) with measuring range 0÷20 UV-index,

LP UVI 02 AV is a voltage loop transmitter with measuring range 0÷16 UV-index; the output, depending on the version, is: 0-1V, 0-5V 0-10V.
 LP UVI 02.1 AV is a voltage loop transmitter with measuring range 0÷20 UV-index; the output, depending on the version, is: 0-1V, 0-5V 0-10V.

The versions 02.1 have a full scale that reach 20 UV-index and are suitable for the measurement of UV in equatorial areas and high mountain; as demonstrated by recent studies, in these places index value UV of 11 can be exceeded for a significant time.

The power supplied is required at 8-30 Vdc, except for the version LP UVI 02 AV10 (voltage output 0-10 V) which is of 15-30 Vdc.

The instrument is managed to operate for long periods without maintenance (except cleaning of the dome and checking the status of silica gel) provided that it is properly powered. This feature makes the device ideal for use in remote weather stations also.

The radiometer can also be used for monitoring of solar UV. Today, many services that provide weather data include the UV index in the available data. The data are used to determine the degree of protection required for the sunlight does not cause damage to the skin and then to human health.

L'UV_index in accordance with the requirements of WMO is calculated from total Effective Irradiance E_{eff} W/m² using the following formula:

$$UV_index = E_{eff} [W/m^2] \times 40 [UV_index]/[W/m^2]$$

The UV-index scale indicates the potential damage that the solar ultraviolet radiation causes the skin and the eyes. The higher the value of UV-index the greater the likelihood of damage. Improve knowledge of the UV means improving the prevention of skin diseases; in fact, correct information of this index allows to take adequate measures.

In Figure 1.1 shows the values of the UV index and the category of exposure.

The World Health Organization, according to the index measured, prescribes a series of protective measures to be taken to minimize the damage caused by ultraviolet rays - Figure 1.2.

In recent years, aided by the ozone hole, the attention given by the World Health Organization (http://www.who.int/uv/intersunprogramme/activities/uv_index/en/) to the problem of exposure to ultraviolet radiation is increasing, as evidenced by the growth of scientific articles number regarding this topic.

2 Working Principle

The radiometer LP UVI 02 is based on an innovative solid state sensor, whose spectral response has been adapted to that of the weighting curve UV (CIE, Erythema action curves). In Figure 2.1 shows the comparison between the spectral response of Delta0hm probe and the UV action curve (Erythema).

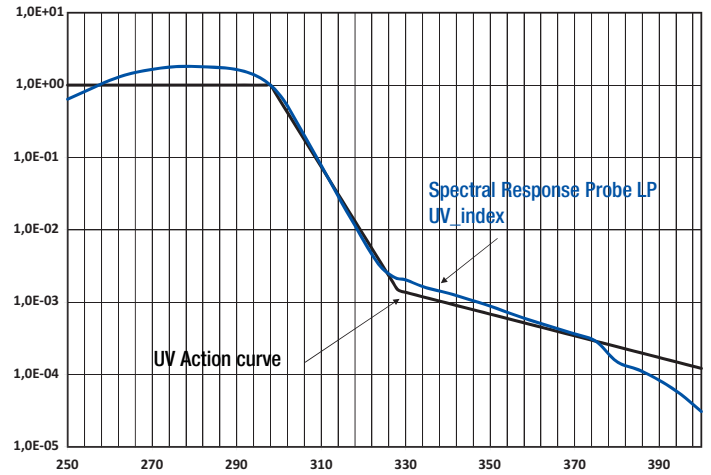

Figure 2.1: Spectral response probe LP UVI 02

LP UVI 02 is equipped with a quartz dome with outer diameter of 50 mm in order to ensure adequate protection of the sensor to atmospheric agents.

The answer according to the cosine law has been obtained through the use of a new material with excellent diffusion properties and transparency to ultraviolet. The deviation between the theoretical and the measured response is shown in figure 2.2.

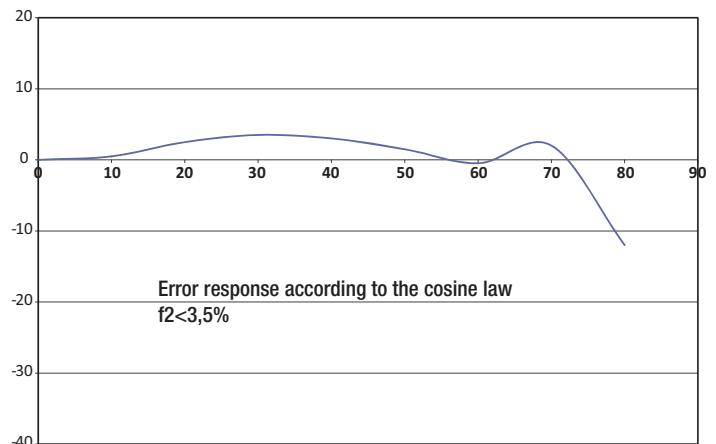

Figure 2.2: Error response according to the cosine law.



LP UVI 02



LP UVI 02

The excellent agreement between the response of LP UVI 02 and cosine (error f2 <3.5%) allows you to use it even when the sun elevation is low (the diffuse component of solar ultraviolet light increases as the sun moves away from the zenith, so the error on direct component due to imperfect response according to the cosine law, becomes negligible on the measurement of global radiation).

3 Installing the radiometer to measure UV_index :

Before installing the radiometer, refill the cartridge containing silica-gel. The silica gel has the function of absorbing the humidity in the dome chamber, moisture in particular climatic conditions can lead to the formation of condensation on the inner wall of the dome by altering the measurement. The silica gel when it absorbs moisture and becomes saturated (becoming inefficient) changes color from yellow to white transparent.

During the loading of silica-gel you should avoid getting it wet or touch it with your hands. The steps to be performed in a dry environment (as possible) are:

- 1- Loosen the three screws that fix the white shade
- 2- Unscrew the cartridge door silica gel with a coin
- 3- Remove the cartridge perforated cap
- 4- Open the sachet (supplied with the radiometer) containing silica gel
- 5- Fill the cartridge with the silica-gel
- 6- Close the cartridge with its own cap, making sure that the O-ring seal is positioned correctly
- 7- Screw the cartridge to the radiometer body using a coin
- 8- Check that the cartridge is screwed tightly (if not the duration of the silica-gel is reduced)
- 9- Position the screen and lock it with the screws
- 10-The radiometer is ready for use

Figure 3.1 shows the operations necessary to fill the cartridge with the silica-gel.

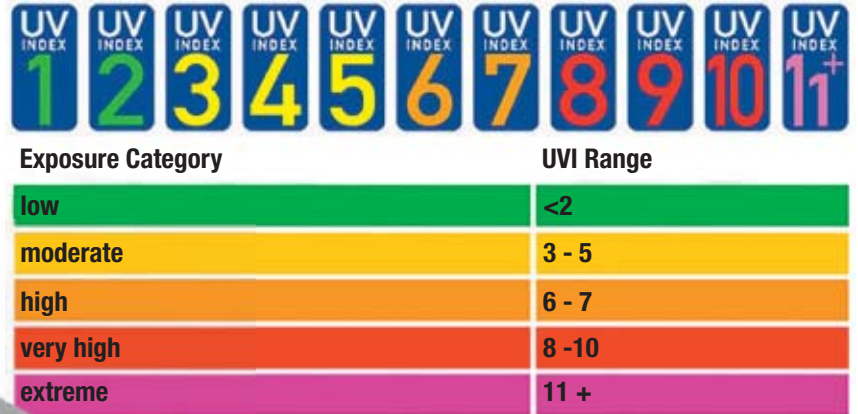

Figure 1.1: UV index and exposure category

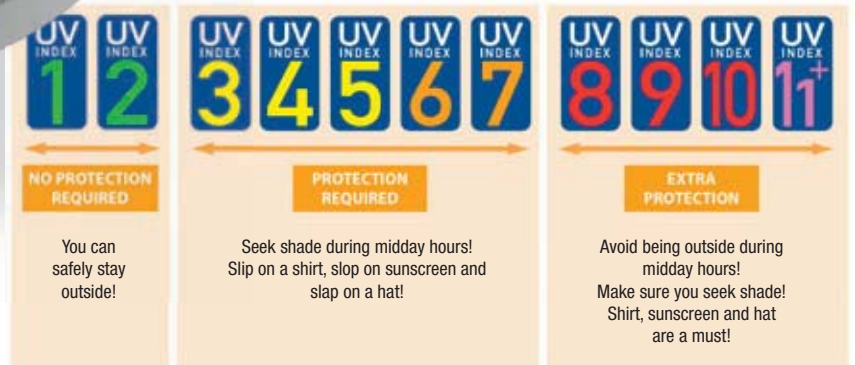
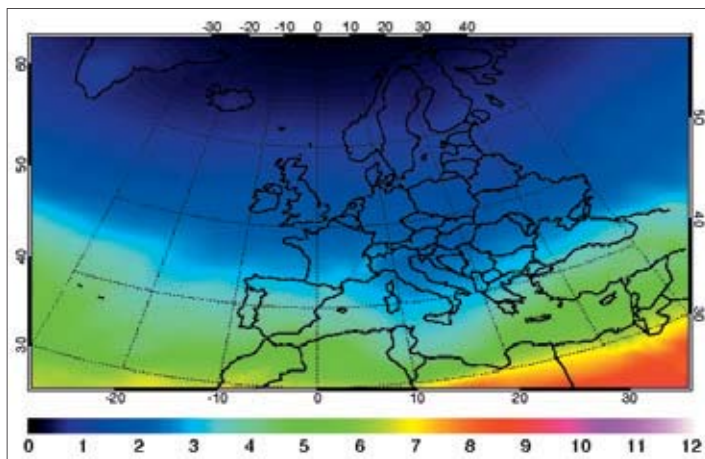
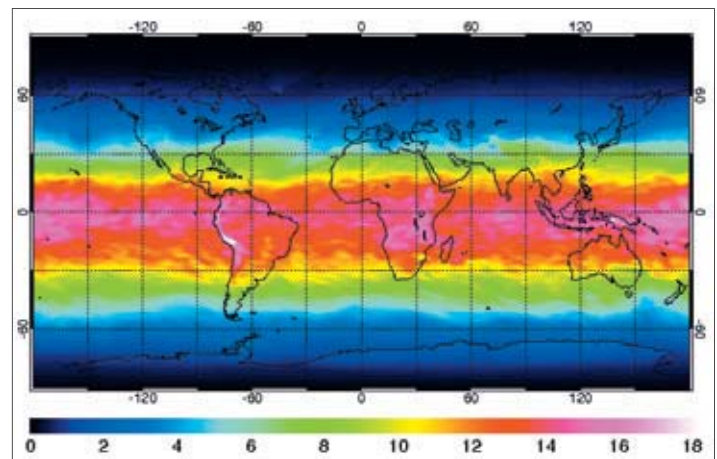

Figure 1.2: WHO prescription according to the UV index



UV index today Europe



UV index today World

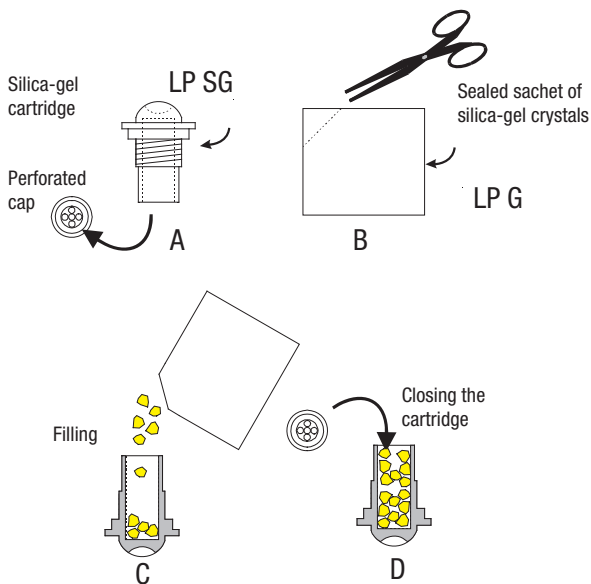

Figure 3.1

- The LP UVI 02 should be installed in a location easily accessible for periodic cleaning of the outer dome and maintenance. At the same time it should be avoided buildings, trees or obstacles of any kind which exceed the horizontal plane on which lies the radiometer. In case this is not possible, select a location where obstacles on the path of the sun from sunrise to sunset is less than 5°.
- The radiometer should be placed away from any obstacle that might reflect the sun (or shadow) onto the radiometer.
- For an accurate horizontal installation, the radiometer has a bubble level; the adjustment is made with the two screws with nut registration which allow the vary of the angle of the radiometer. The fixation on a plane can be performed by using the two holes of 6mm diameter and spacing of 65 mm. In order to access holes to remove the screen and reposition it after mounting, see Figure 3.3.
- The support LP S1 (figure 3.2), supplied on demand as an accessory, allows easy mounting of the radiometer on a mast. The maximum diameter of the pole to which the support can be set is 50 mm. The installer will check that the height of the mast does not exceed the level of the radiometer, not to introduce measurement errors caused by reflections and shadows caused by the pole. To fix the radiometer to the mounting bracket, remove the screen, removing the three screws, fix the radiometer, the installation is complete reattach white screen.
- It is better to insulate the radiometer from its support; at the same time make sure there is a good electrical contact to ground.



Figure 3.3

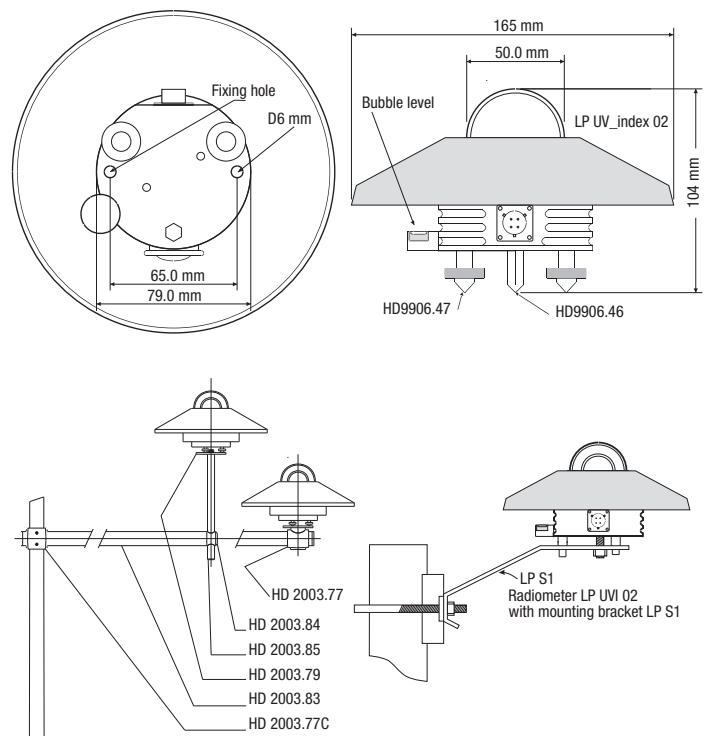

Figure 3.2

4 Electrical Connections and requirements for electronic reading:

LP UVI 02 is produced with current output and voltage output: LP UVI 02 AC and LP UVI 02 AV.

- Both versions require power supply 8-30 VDC.
- All models come with an output connector M12 4-pole
- The cable, optional, finished on one side with M12 male connector, 4-pin, is UV resistant, has 3 wires plus the braid (screen); the correspondence between the colors of the cable and connector poles is the following (figure 4.1):

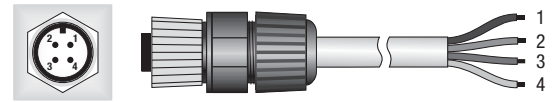

Figure 4.1

LP UVI 02 AC

Connector	Operation	Color
4	Shield (\perp)	Black
1	Positive (+)	Red
2	Negative (-)	Blue
3	Case (\rightarrow)	White

LP UVI 02 AV

Connector	Operation	Color
4	Shield (\perp)	Black
1	(+) Vout	Red
2	(-) Vout e (-)Vcc	Blue
3	(+) Vcc	White

- The LP UVI 02 AC, with an adequate power supply, can be connected to a multimeter or to a data logger according to the following scheme (Figure 4.2), the load resistance for the reading of the signal must be \approx 500 W:

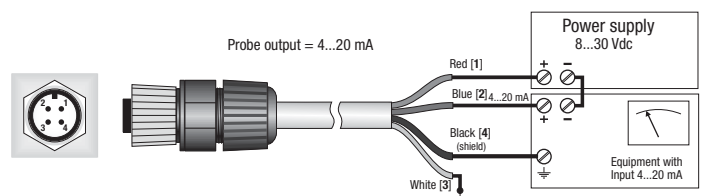

Figure 4.2: Connection diagram of LP UVI 02 AC.

- The LP UVI 02 AV, with a suitable power supply, can be connected to a multimeter or to a data logger according to the following diagram (Figure 7), the load resistance for the reading of the signal must be \approx 100 KW:

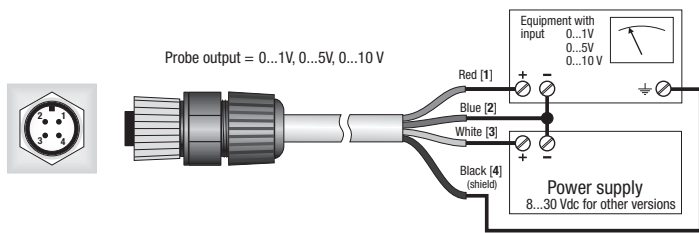

Figure 4.3: Connection diagram of LP UVI 02 AV.

5 Maintenance:

In order to ensure high accuracy of the measurements, it is necessary that the outer dome of the radiometer be always kept clean; therefore, the higher the frequency of cleaning of the dome the better the accuracy of the measurements. Cleaning can be done with normal maps for the cleaning of lens paper and water, if it was not just use pure ethyl alcohol. After cleaning with alcohol is clean again the dome with water only.

Due to the high temperature changes between day and night is possible that the dome of the radiometer condense, in this case the performed reading is highly over-estimated. To minimize the condensation growth, the radiometer is provided with a cartridge with absorbent material: Silica gel. The efficiency of the Silica gel crystals decreases over time with the absorption of moisture. When crystals of silica gel are efficient their color is yellow, while gradually losing efficiency the color turns white, to replace them, see instructions in paragraph 3. Typically the duration of silica gel ranges from 2 to 6 months depending on the environmental conditions in which the radiometer.

6 Calibration and Measurements:

LP UVI 02 AC

The sensitivity of the radiometer is adjusted at the factory so that
4..20 mA = 0.. 16 unit of UV index

In order to obtain the value of the UV index it is necessary to applied the following formula:

$$UV_index = (I_{out} - 4mA) \cdot \frac{[UV_index]}{[mA]}$$

where;

UV_index: is the UV index expressed in UV index,

I_{out} : is the current in mA absorbed by the instrument

LP UVI 02.1 AC

The sensitivity of the radiometer is adjusted at the factory so that
4..20 mA = 0.. 20 unit of UV index

In order to obtain the value of the UV it is necessary to applied the following formula:

$$UV_index = (I_{out} - 4mA) \cdot \frac{[20 \cdot UV_index]}{[16 \cdot mA]}$$

where;

UV_index: is the UV index expressed in UV index,

I_{out} : is the current in mA absorbed by the instrument

LP UVI 02 AV 1, 5, 10

The sensitivity of the radiometer is adjusted at the factory so that

0..1 V = 0.. 16 unit of UV index

0..5 V = 0.. 16 unit of UV index

0..10 V = 0.. 16 unit of UV index

In order to obtain the value of the UV it is necessary to applied the following formula:

$$UV_index = (V_{out}) \cdot 16 \cdot \frac{[UV_index]}{Vfs}$$

where;

UV_index: is the UV index expressed in UV index,

V_{out} : is the voltage in volts produced by the instrument

Vfs: is the maximum output voltage (Volt 1,5,10) depending on the version chosen.

LP UVI 02.1 AV 1, 5, 10

The sensitivity of the radiometer is adjusted at the factory so that

0..1 V = 0.. 20 unit of UV index

0..5 V = 0.. 20 unit of UV index

0..10 V = 0.. 20 unit of UV index

In order to obtain the value of the UV it is necessary to applied the following formula:

$$UV_index = (V_{out}) \cdot 20 \cdot \frac{[UV_index]}{Vfs}$$

where;

UV_index: is the UV index expressed in UV index,

V_{out} : is the voltage in volts produced by the instrument

Vfs: is the maximum output voltage (Volt 1,5,10) depending on the version chosen.

7 Technical specifications:

Typical sensitivity:	LP UVI 02 AC	4-20mA
	LP UVI 02 AV	1 0-1V,
	LP UVI 02 AV	5 0-5V,
	LP UVI 02 AV	10 0-10V,
Response time:		<0.5 sec (95%)
Measuring range:		0-16 UV_index (version 02)
		0-20 UV_index (version 02.1)
Field of view:		2p sr
Spectral range:		According to the UV weighting curve
Working temperature:		-40 °C, 80 °C
Response according to the cosine law:		< 8 % (between 0° and 80°)
Instabilità a lungo termine:		< 1/2 ± 3 1/2 %
(1 year)		
Non linearity:		< 1 %
Response according to :		< 0.1%/°C
the temperature		
Dimensions:		figure 3.3
Weight:		0.90 Kg

8 Purchasing codes

LP UVI 02 AC: Radiometer supplied with: protection, cartridge for silica-gel, 2 cartridges, spirit level for leveling, flying female 4-pole (M12) and **Report of Calibration**. Current output 4-20mA. Range 0÷16 UVindex

LP UVI 02.1 AC: Radiometer supplied with: protection, cartridge for silica-gel, 2 cartridges, spirit level for leveling, flying female 4-pole (M12) and **Report of Calibration**. Current output 4-20mA. Range 0÷20 UVindex

LP UVI 02 AV1: Radiometer supplied with: protection, cartridge for silica-gel, 2 cartridges, spirit level for leveling, flying female 4-pole (M12) and **Report of Calibration**. Voltage output 0÷1V. Range 0-16 UVindex

LP UVI 02.1 AV1: Radiometer supplied with: protection, cartridge for silica-gel, 2 cartridges, spirit level for leveling, flying female 4-pole (M12) and **Report of Calibration**. Voltage output 0÷1V. Range 0÷20 UVindex

LP UVI 02 AV5: Radiometer supplied with: protection, cartridge for silica-gel, 2 cartridges, spirit level for leveling, flying female 4-pole (M12) and **Report of Calibration**. Voltage output 0÷5V. Range 0-16 UVindex

LP UVI 02.1 AV5: Radiometer supplied with: protection, cartridge for silica-gel, 2 cartridges, spirit level for leveling, flying female 4-pole (M12) and **Report of Calibration**. Voltage output 0÷5V. Range 0÷20 UVindex

LP UVI 02 AV10: Radiometer supplied with: protection, cartridge for silica-gel, 2 cartridges, spirit level for leveling, flying female 4-pole (M12) and **Report of Calibration**. Voltage output 0÷10V. Range 0÷16 UVindex

LP UVI 02.1 AV10: Radiometer supplied with: protection, cartridge for silica-gel, 2 cartridges, spirit level for leveling, flying female 4-pole (M12) and **Report of Calibration**. Voltage output 0÷10V. Range 0-20 UVindex

CP M12AA 4.5: Cable socket 4-pin female (M12) complete with UV-resistant cable, L=5m.

CP M12AA 4.10: Cable socket 4-pin female (M12) complete with UV-resistant cable, L=10m.

HD 2003.85: Adjustable height fixing kit for mounting the radiometer on a Ø 40mm pole (HD2003.84 + HD2003.85 + HD2003.79)

LP SP1: Protective screen made of UV resistant plastic. LURAN S777K of BASF

LP S1: Bracket for positioning the radiometer LP UV index on a suitable pole with a maximum diameter of 50mm

LP SG: Cartridge with silica-gel complete ring and cap.

LP G: Pack of 5 cartridges of silica-gel

MANUFACTURE OF PORTABLE AND BENCH TOP SCIENTIFIC INSTRUMENTS

Current and voltage loop transmitters and regulators
Temperature - Humidity, Dew point - Pressure - CO, CO₂
Air speed - Light - Optical Radiation
Acoustics - Vibration
Data logger - Data logger wireless
Microclimate
pH - Conductivity - Dissolved Oxygen - Turbidity
Elements for weather stations



ACCREDIA
L'ENTE ITALIANO DI ACCREDITAMENTO

LAT N° 124 Signatory of EA, IAF and ILAC Mutual Recognition Agreements
Temperature - Humidity - Pressure - Air speed
Photometry/Radiometry - Acoustics

CE CONFORMITY

- Safety: EN61000-4-2, EN61010-1 Level 3
- Electrostatic discharge: EN61000-4-2 Level 3
- Electric fast transients: EN61000-4-4 Level 3, EN61000-4-5 Level 3
- Voltage variations: EN61000-4-11
- Electromagnetic interference susceptibility: IEC1000-4-3
- Electromagnetic interference emission: EN55022 class B



Delta Ohm srl
Via G. Marconi, 5
35030 Caselle di Selvazzano (PD) - Italy
Tel. 0039 0498977150 r.a.
Fax 0039 049635596
e-mail: info@deltaohm.com
Web Site: www.deltaohm.com

