

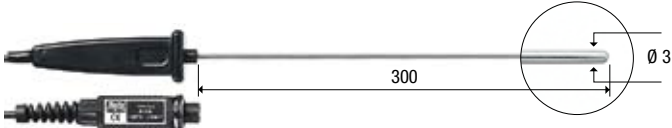

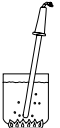

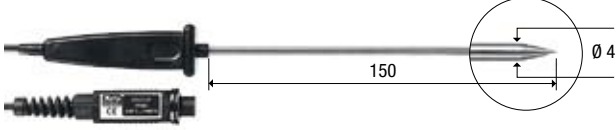





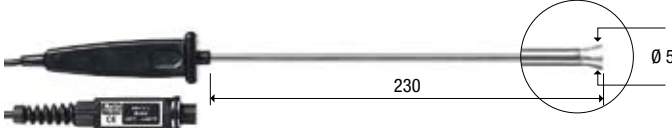

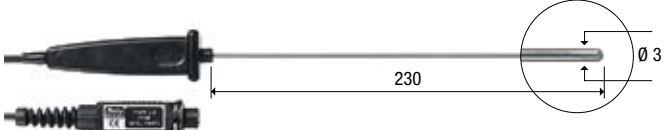
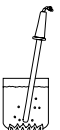

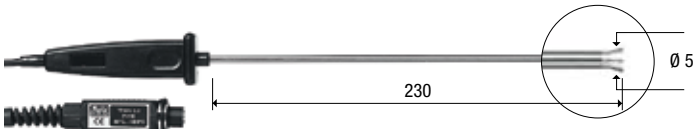

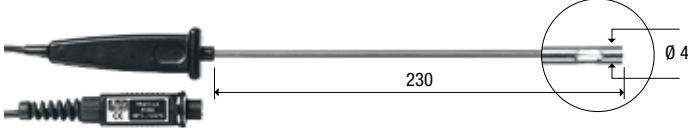
PT100 PROBES FOR PORTABLE INSTRUMENTS EQUIPPED WITH SICRAM MODULE

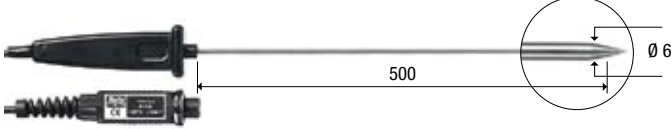
CODE	°C max	τ s	DIMENSIONS	USE
TP 472 I	-196 +500	3s		
TP 473 P	-50 +400	5s		
TP 474 C	-50 +400	5s		
TP 472 I.O	-50 +400	3s		
TP 473 P.O	-50 +400	5s		
TP 474 C.O	-50 +400	5s		
TP 475 A.O	-50 +250	12s		
TP 472 I.5	-50 +400	3s		
TP 472 I.10	-50 +400	3s		

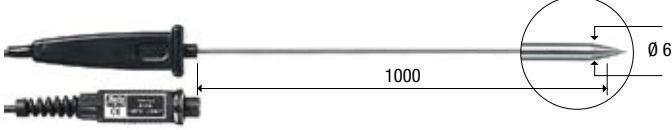

Temperature

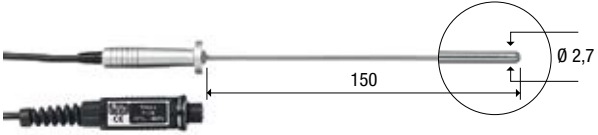
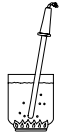
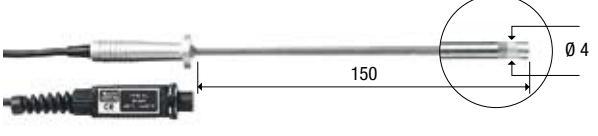
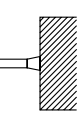
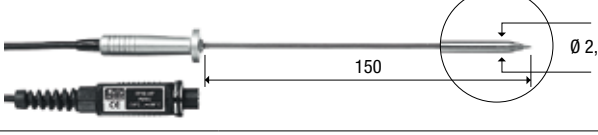
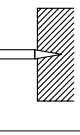
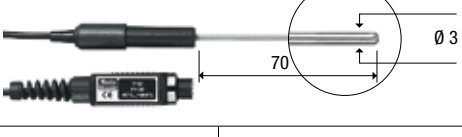
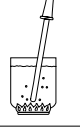
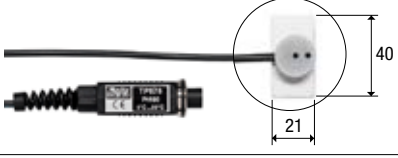
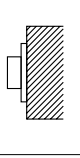
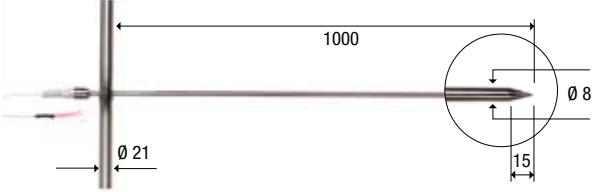
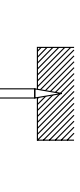



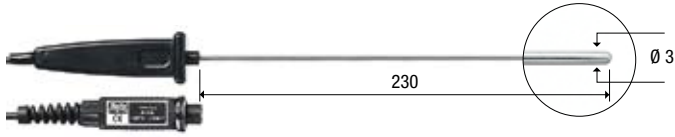
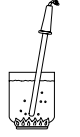

Pt100 PROBES FOR PORTABLE INSTRUMENTS EQUIPPED WITH SICRAM MODULE

CODE	°C max	τ s	DIMENSIONS		USE
TP 49 A	-70 +400	3,5s			
TP 49 AC	-70 +400	5,5s			
TP 49 AP	-70 +400	4s			
TP 87	-50 +200	3s			
TP 878	+5 +80	60s	Contact probe for solar panels. Cable L = 2m.		
TP 878.1	+5 +80	60s	Contact probe for solar panels. Cable L = 5m.		
TP879	-20 +120	60s	Penetration probe for compost. Cable L = 2m 		
TP 875	-30 +120	15s	Globe-thermometer probe for measuring radiant heat \varnothing 150 mm. (ISO7243, ISO7726). 4 wires Pt100 Sensor cable L=2m. Equipped with SICRAM module.		
TP 876	-30 +120	15s	Globe-thermometer probe for measuring radiant heat \varnothing 50 mm. (ISO7243, ISO7726). 4 wires Pt100 Sensor cable L=2m. Equipped with SICRAM module.		

Pt100 / Pt1000 SENSOR PROBES WITH TP 47 MODULE

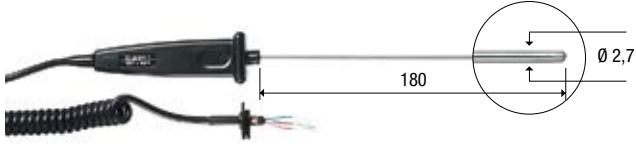
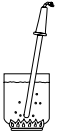
CODE	°C max	τ s	DIMENSIONS		USE
TP 47.100 (Pt100) TP 47.1000 (Pt1000)	-50 +400	3s			
TP 47	Only connector for connection of probes without SICRAM module: direct 3 and 4 wires Pt100, 2 wires Pt1000.				

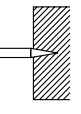
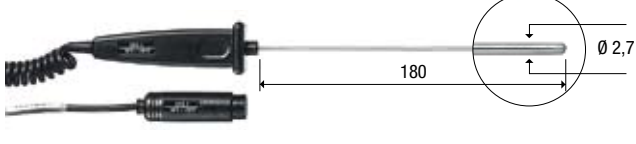
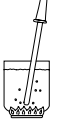
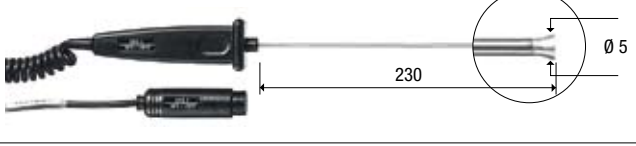
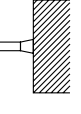
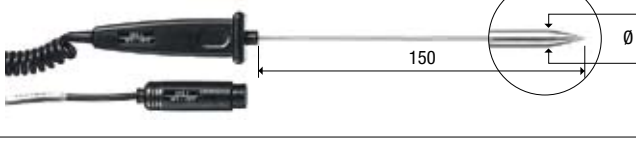
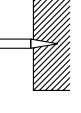
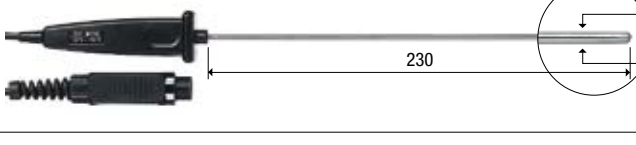
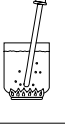
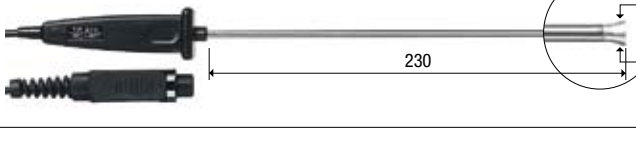
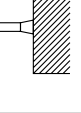
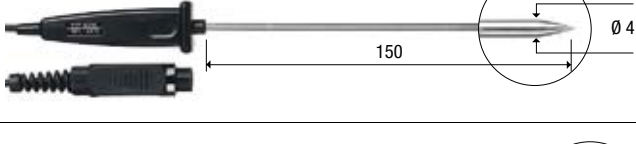
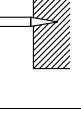
Pt100 SENSOR PROBES FOR OBSOLETE INSTRUMENTS

CODE	°C max	τ s	DIMENSIONS	USE
S 8601 P	-50 +200	3,5s		
S 8601 PP	-50 +200	5s		
STS 3	-50 +150	3,5s		
STS 3/C	-50 +150	5s		
STS 3/P	-50 +150	5s		
TP 870	-50 +400	3s		
TP 870 C	-50 +400	5s		
TP 870 P	-50 +400	5s		
TP 870 A	-50 +250	12s		



Temperature



Pt100 SENSOR PROBES FOR OBSOLETE INSTRUMENTS

CODE	°C max	τ s	DIMENSIONS		USE
TP 871	-50 +200	3s			
TP 872/500	-50 +400	10s			
TP 872/1000					
TP 873	-50 +500	6s			
TP 874	-30 +200	3s			
TP 875.1	-30 +120	15s	<p>Globe-thermometer probe for measuring radiant heat \varnothing150 mm. (ISO7243, ISO7726). 4 wires Pt100 sensor cable L=2m.</p>		
TP 876.1	-30 +120	15s	<p>Globe-thermometer probe for measuring radiant heat \varnothing50 mm. (ISO7243, ISO7726). 4 wires Pt100 sensor cable L=2m.</p>		
TP 877	-200 +400	3s			
TP879.1	-20 +120	60s	<p>Penetration probe for compost 4 wires cable L = 2 m</p>		

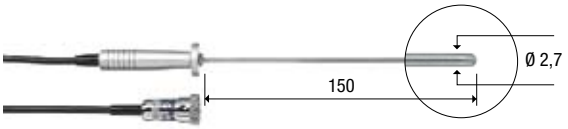
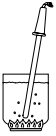
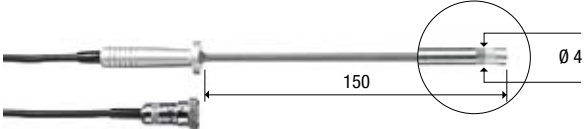
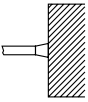
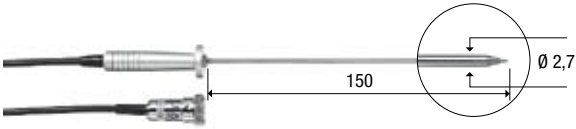
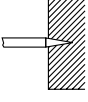
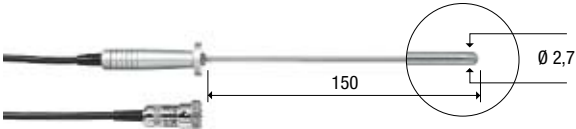
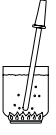
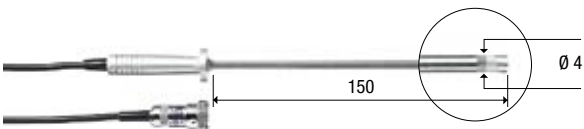
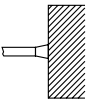
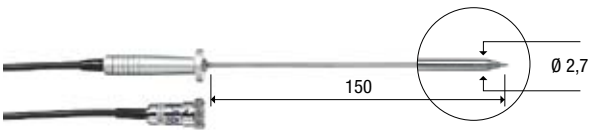
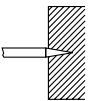
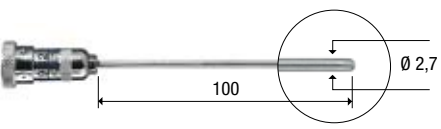
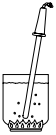
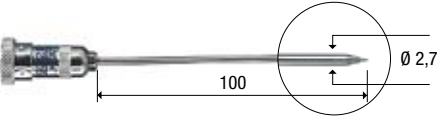
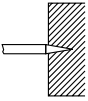
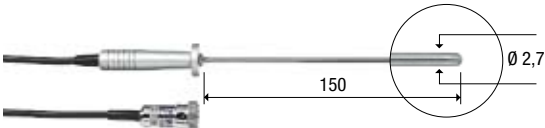
Pt100 SENSOR PROBES FOR OBSOLETE INSTRUMENTS

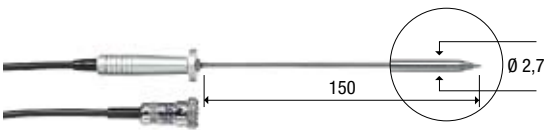
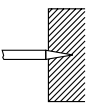
CODE	°C max	τ s		DIMENSIONS	USE
TP 9 A	-70 +400	3,5s	CLASS A		
TP 9 AC	-70 +400	5,5s	CLASS A		
TP 9 AP	-70 +400	4s	CLASS A		
TP 93	-70 +400	3,5s	CLASS 1/3 DIN		
TP 93 C	-70 +400	5,5s	CLASS 1/3 DIN		
TP 93 P	-70 +400	4s	CLASS 1/3 DIN		
TP 932	-70 +200	3,5s	CLASS 1/3 DIN		
TP 932 P	-70 +200	4s	CLASS 1/3 DIN		
TP 95	-70 +400	3,5s	CLASS 1/5 DIN		
TP 95 P	-70 +400	4s	CLASS 1/5 DIN		

Temperature

When temperature exceeds 400°C avoid violent impact and thermal shock, as the Pt100 sensor may get irreparably damaged.