



LP PHOT 03  
 LP RAD 03  
 LP PAR 03  
 LP UVA 03  
 LP UVB 03  
 LP PHOT 03S



**TECHNICAL SPECIFICATIONS:**

|  |   |
|--|---|
| Typical sensitivity:   | 0.5...1.5 mV/(klux)   |
| Spectral range:  | V( $\lambda$ )  |
| Calibration uncertainty:   | < 4%  |
| f <sub>1</sub> (agreement with the standard curve V( $\lambda$ )): | <6%   |
| f <sub>2</sub> (Cosine response)                                   | <3%   |
| f <sub>3</sub> (linearity)   | <1%   |
| Operating temperature:   | -20°C...+60°C   |
| Impedance:   | 0.5...1.0 k $\Omega$ non-normalized version   |
| Version with normalized output 4...20mA:                           | 4mA = 0 klux, 20mA = 150 klux   |
| Version with normalized output 0...10Vdc                           | 0V = 0 klux, 10V = 150klux  |
| Power supply:  | 10...30Vdc for version with normalized output 4...20mA<br>15...30Vdc for version with normalized output 0...10Vdc |

Typical spectral response curve of LP PHOT 03:

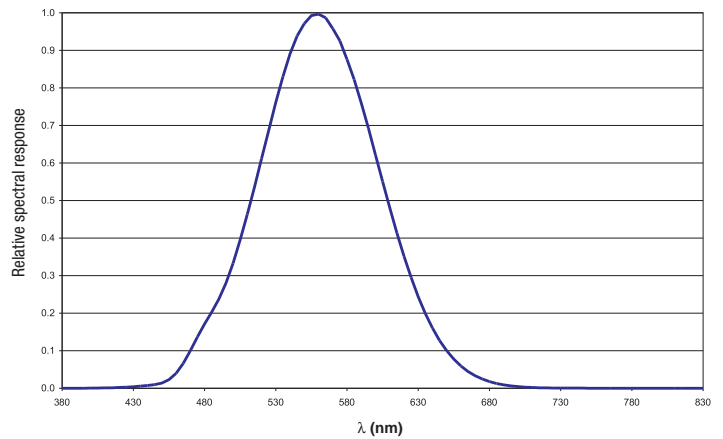

Light

**LP PHOT 03 - LP RAD 03 - LP PAR 03 - LP UVA 03 - LP UVB 03 - LP PHOT 03S  
 PHOTOMETRIC AND RADIOMETRIC PROBES WITH OUTPUT SIGNAL IN mV  
 OR NORMALIZED 4...20mA OR 0...10Vdc OR RS485 MODBUS-RTU OUTPUT**

Photo-radiometric probes with output signal in mV or standard output 4...20mA or 0...10Vdc. The probes of the series LP...03 for outdoor use allow to measure photometric and radiometric quantities such as: illuminance (lux), irradiance (W/m<sup>2</sup>) in the near ultraviolet spectral region VIS-NIR, UVA, UVB, and the photon flow across the PAR region (400nm...700nm). The probes with mV output do not require any power supply. The output signal is obtained from a resistance that short-circuits the terminal of the photodiode. The ratio of generated photocurrent to incident light power is converted into a Difference of Potential that can be read by a voltmeter. Once the DDP (Difference of Potential) is known, the measured value can be calculated through the calibration factor. **All probes are individually calibrated and the calibration factor is also shown on the probe housing.** The probes with normalized output current 4...20mA or voltage 0...10Vdc or RS485 MODBUS RTU output require external power supply. The probe LP UVB 03 is available only with standard output voltage 0...5Vdc and requires external power supply. All probes of the series LP...03 are equipped with diffuser for cosine correction and protection dome. **M12 male 4-pole connector (M12 8-pole connector for the LP UVB 03).** Cables with female connectors and with 2, 5 or 10m length available on request.

**LP PHOT 03**

The probe LP PHOT 03 measures illuminance (lux), defined as the ratio between the luminous flux (lumen) passing through a surface and the surface area (m<sup>2</sup>). The spectral response curve of a photometric probe is similar to the human eye curve, known as standard photopic curve V( $\lambda$ ). The difference in spectral response between LP PHOT 03 and the standard photopic curve V( $\lambda$ ) is calculated by means of the error f<sub>1</sub>. Calibration is carried out by comparison with a reference luxmeter, calibrated by a Primary Metrological Laboratory. The Calibration Procedure complies with the CEI publication No.69 "Methods of characterizing illuminance meters and luminance meters: Performance characteristics and specifications, 1987". The photometric measurement probe is designed for outdoor readings. CIE photopic filter. Cosine correction filter and K5 glass dome. Output, according to the chosen configuration, mV or normalized output 4...20mA or 0...10Vdc.

**ORDERING CODE**

**LP PHOT 03:** Photometric probe for the measurement of illuminance, complete with K5 dome, silica gel cartridge, female 4-pole connector, calibration report. **Cable with female connector has to be ordered separately.** Cables: **CPM12 AA4** ...with cable length 2, 5 or 10 meters.

|                |                          |  |
|----------------|--------------------------|--|
| <b>LP PHOT</b> | <input type="checkbox"/> | <b>03</b> = mV / klux<br><b>03BL</b> = mV / klux output, base with levelling device<br><b>03BLAC</b> = base with levelling device output 4...20 mA<br><b>03BLAV</b> = base with levelling device output 0...10 V |
|----------------|--------------------------|--|

|               |                          |  |
|---------------|--------------------------|--|
| <b>CABLE:</b> | <input type="checkbox"/> | <b>2</b> = length 2m<br><b>5</b> = length 5m<br><b>10</b> = length 10m |
|---------------|--------------------------|--|

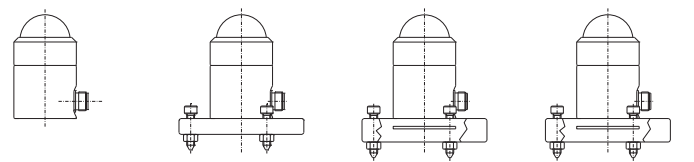

LP PHOT 03      LP PHOT 03BL      LP PHOT 03BLAC      LP PHOT 03BLAV

WIRING DIAGRAM  
4-pole wire CPM12AA4...

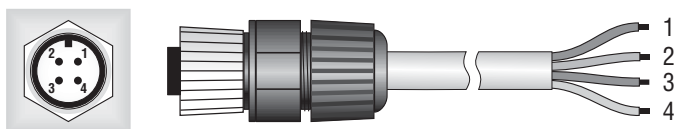

Fixed 4-pole plug M12 Flying 4-pole M12 connector

LPPHOT 03, LP PHOT 03BL

| Connector | Function      | Color |
|-----------|---------------|-------|
| 1         | Positive (+)  | Red   |
| 2         | Negative (-)  | Blue  |
| 3         | Not connected | White |
| 4         | Shield        | Black |

LP PHOT 03BLAV

| Connector | Function              | Color |
|-----------|-----------------------|-------|
| 1         | (+) V out             | Red   |
| 2         | (-) V out and (-) Vdc | Blue  |
| 3         | (+) Vdc               | White |
| 4         | Shield                | Black |

LP PHOT 03BLAC

| Connector | Function              | Color |
|-----------|-----------------------|-------|
| 1         | Positive (+), (+) Vdc | Red   |
| 2         | Negative (-), (-) Vdc | Blue  |
| 3         | Not connected         | White |
| 4         | Shield                | Black |

LP RAD 03

LP RAD 03 probe measures irradiance ( $W/m^2$ ) defined as the ratio between the radiant flux ( $W$ ) passing through a surface and the surface area ( $m^2$ ) in the VIS-NIR (400nm- 1050nm) spectral range. The probe is designed for outdoor readings.

Cosine correction filter and K5 glass dome. Output, according to the chosen configuration, in  $\mu V$  per  $\mu W/cm^2$  or 4...20mA or 0...10Vdc normalized output.

TECHNICAL SPECIFICATIONS

|                          |   |
|--------------------------|---|
| Typical sensitivity:     | 1...2.5 $\mu V/(\mu W/cm^2)$                  |
| Spectral range:          | 400nm...1050nm                                |
| Calibration uncertainty: | <5%   |
| $f_2$ (cosine response): | <3%   |
| $f_3$ (linearity)        | <1%   |
| Operating temperature:   | -20°C...+60°C                                 |
| Impedance:               | 0.5...1.0 k $\Omega$ (non-normalized version) |

Version with normalized output 4...20mA: 4mA = 0  $W/m^2$ , 20mA = 2000  $W/m^2$

Version with normalized output 0...10Vdc: 0V = 0  $W/m^2$ , 10V = 2000  $W/m^2$

Power supply: 10...30Vdc for version with normalized output 4...20mA  
15...30Vdc for version with normalized output 0...10Vdc

Typical spectral response curve LP RAD 03

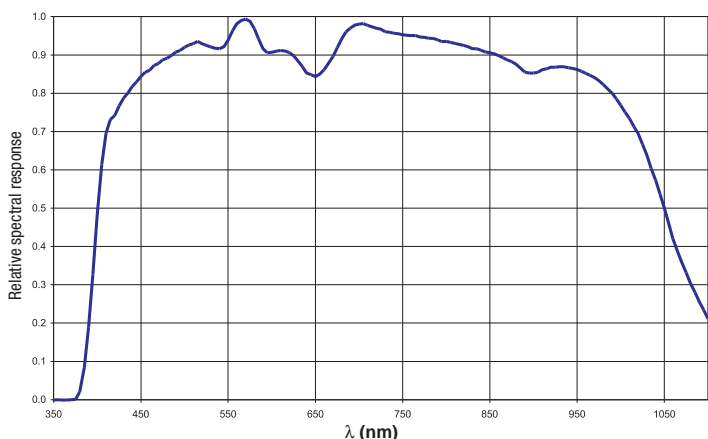

ORDERING CODE

LP RAD 03: Radiometric probe for the measurement of irradiance, complete with K5 dome, silica gel cartridge, 4-pole connector. Cable with female connector has to be ordered separately  
Cables: CPM12 AA4... with cable length 2, 5 or 10 meters.

|        |  |
|--------|--|
| LP RAD | 03 = $\mu V/(\mu W/cm^2)$ output                               |
|        | 03BL = $\mu V/(\mu W/cm^2)$ output, base with levelling device |
|        | 03BLAC = base with levelling device output 4...20 mA           |
|        | 03BLAV = base with levelling device output 0...10 V            |

|           |                 |
|-----------|-----------------|
| CABLE:    |                 |
| CPM12 AA4 | 2 = length 2m   |
|           | 5 = length 5m   |
|           | 10 = length 10m |

WIRING DIAGRAM  
4-pole wire CPM12 AA4...

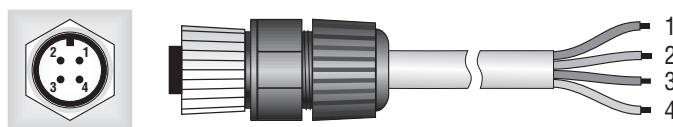

Fixed 4-pole plug M12 Flying 4-pole M12 connector

LP RAD 03, LP RAD 03BL

| Connector | Function      | Color |
|-----------|---------------|-------|
| 1         | Positive (+)  | Red   |
| 2         | Negative (-)  | Blue  |
| 3         | Not connected | White |
| 4         | Shield        | Black |

LP RAD 03BLAV

| Connector | Function              | Color |
|-----------|-----------------------|-------|
| 1         | (+) V out             | Red   |
| 2         | (-) V out and (-) Vdc | Blue  |
| 3         | (+) Vdc               | White |
| 4         | Shield                | Black |

LP RAD 03BLAC

| Connector | Function      | Color |
|-----------|---------------|-------|
| 1         | Positive (+)  | Red   |
| 2         | Negative (-)  | Blue  |
| 3         | Not connected | White |
| 4         | Shield        | Black |

LP PAR 03

The probe LP PAR 03 measures the ratio between the number of photons that strike a surface in one second, in the 400nm...700nm spectral range and the surface area ( $m^2$ ).

This quantity is defined as PAR: Photo-synthetically Active Radiation.

The probe calibration is carried out by using an halogen lamp, with a known spectral irradiance in a specific spectral range. Temperature slightly affects the probe spectral response.

The probe is designed for outdoor readings. Cosine correction filter and K5 glass dome. Output, according to the chosen configuration, in  $\mu V$  per  $\mu mol m^{-2}s^{-1}$  or normalized outputs 4...20mA or 0...10Vdc.

TECHNICAL SPECIFICATIONS

|                          |   |
|--------------------------|---|
| Typical sensitivity:     | 1...2.5 $\mu V/(\mu mol(m^2s^{-1}))$        |
| Typical spectral range:  | 400 nm...700 nm                             |
| Calibration uncertainty: | <5%   |
| $f_2$ (cosine response): | <3%   |
| $f_3$ (linearity)        | <1%   |
| Operating temperature:   | -20°C...+60°C                               |
| Impedance:               | 0.5...1.0 k $\Omega$ non-normalized version |

Version with normalized output 4...20mA: 4mA = 0  $\mu mol(m^2s^{-1})$ , 20mA = 5000  $\mu mol(m^2s^{-1})$

Version with normalized output 0...10Vdc: 0V =  $\mu mol(m^2s^{-1})$ , 10V = 5000  $\mu mol(m^2s^{-1})$

Power supply: 10...30Vdc for version with normalized output 4...20mA  
15...30Vdc for version with normalized output 0...10Vdc

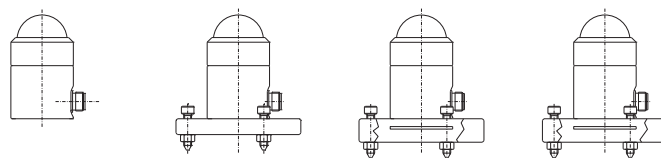

LP RAD 03

LP RAD 03BL

LP RAD 03BLAC

LP RAD 03BLAV

Typical spectral response curve **LP PAR 03**:

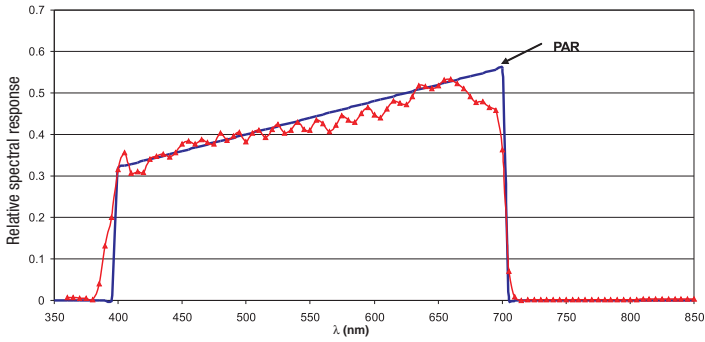

**ORDERING CODE**

**LP PAR 03** Radiometric probe for the measurement of the Photon flux in the PAR action spectra, complete with K5 dome, silica gel cartridge, 4-pole connector. **Cable with female connector has to be ordered separately.** Cables: **CPM12 AA4** ...with cable length 2, 5 or 10 meters

|               |                          |   |
|---------------|--------------------------|---|
| <b>LP PAR</b> | <input type="checkbox"/> | <b>03</b> = $\mu\text{V}/(\mu\text{mol m}^{-2}\text{s}^{-1})$ output<br><b>03BL</b> = $\mu\text{V}/(\mu\text{mol m}^{-2}\text{s}^{-1})$ output, base with levelling device<br><b>03BLAC</b> = base with levelling device, output 4...20 mA<br><b>03BLAV</b> = base with levelling device, output 0...10 V |
| <b>CABLE:</b> | <input type="checkbox"/> | <b>2</b> = length 2m<br><b>5</b> = length 5m<br><b>10</b> = length 10m  |

**WIRING DIAGRAM**

**4-pole wire CPM12 AA4...**

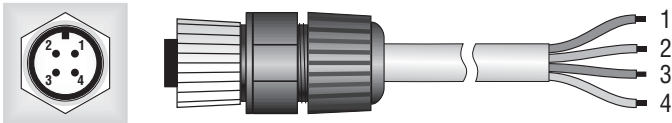

Fixed 4-pole plug M12      Flying 4-pole M12 connector

**LP PAR 03, LP PAR 03BL**

| Connector | Function      | Color |
|-----------|---------------|-------|
| 1         | Positive (+)  | Red   |
| 2         | Negative (-)  | Blue  |
| 3         | Not connected | White |
| 4         | Shield        | Black |

**LP PAR 03BLAV**

| Connector | Function             | Color |
|-----------|----------------------|-------|
| 1         | (+) V out            | Red   |
| 2         | (-) Vout and (-) Vdc | Blue  |
| 3         | (+) Vdc              | White |
| 4         | Shield               | Black |

**LP PAR 03BLAC**

| Connector | Function      | Color |
|-----------|---------------|-------|
| 1         | Positive (+)  | Red   |
| 2         | Negative (-)  | Blue  |
| 3         | Not connected | White |
| 4         | Shield        | Black |

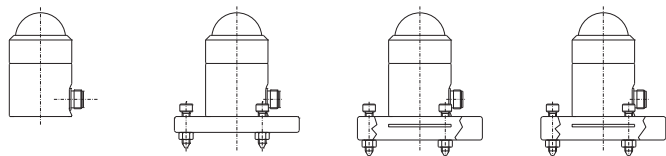

**LP PAR 03      LP PAR 03BL      LP PAR 03BLAC      LP PAR 03BLAV**

**LP UVA 03**

The LP UVA 03 probe measures irradiance ( $\text{W}/\text{m}^2$ ) defined as the ratio between the radiant flux ( $\text{W}$ ) passing through a surface and the surface area ( $\text{m}^2$ ) in the UVA (315 nm...400 nm) spectral range. Thanks to a new type of photodiode, LP UVA 03 is blind to visible and infrared light. Probe calibration is carried out by using a 365 nm line of a Xe-Hg, filtered through a special interferential filter. Measurement is carried out by comparison with the primary standards, assigned to Delta Ohm Metrological Laboratory. The probe is designed for **outdoor readings**. Cosine correction filter and K5 glass dome. Output, according to the chosen configuration, in  $\mu\text{V}$  per  $\mu\text{W}/\text{cm}^2$  or 4...20mA or 0...10Vdc normalized output.

**TECHNICAL SPECIFICATIONS**

|  |   |
|--|---|
| Typical sensitivity:                       | 70...200 $\mu\text{V}/(\text{W}/\text{m}^2)$  |
| Measuring range:                           | 327...384nm (1/2)<br>312...393nm (1/10)<br>305...400nm (1/100)<br>Peak: 365nm                                     |
| Calibration uncertainty:                   | <6%   |
| $f_2$ (cosine response):                   | <6%   |
| $f_3$ (linearity)                          | <1%   |
| Operating temperature:                     | -20°C...+60°C   |
| Impedance:                                 | 0.5...1.0 k $\Omega$ non-normalized version   |
| Version with normalized output 4...20mA:   | 4mA = 0 $\text{W}/\text{m}^2$ , 20mA = 200 $\text{W}/\text{m}^2$  |
| Version with normalized output 0...10Vdc : | 0V = 0 $\text{W}/\text{m}^2$ , 10V = 200 $\text{W}/\text{m}^2$  |
| Power supply:                              | 10...30Vdc for version with normalized output 4...20mA<br>15...30Vdc for version with normalized output 0...10Vdc |

Typical spectral response curve **LP UVA 03**:

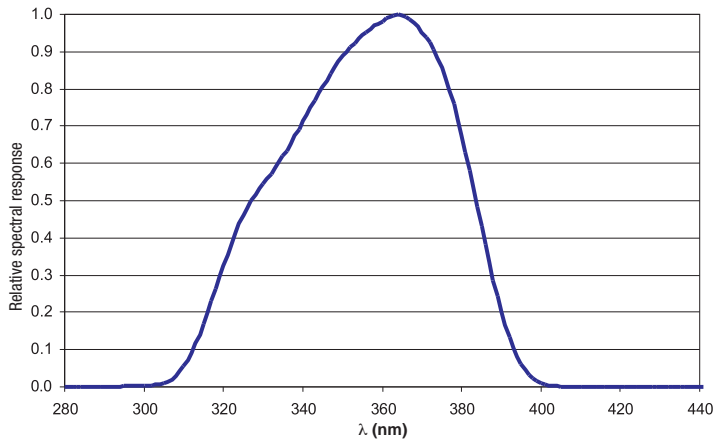

Light

**ORDERING CODE**

**LP UVA 03:** Radiometric probe for the measurement of the UVA irradiance, complete with K5 dome, silica gel cartridge, 4-pole connector. **Cable with female connector has to be ordered separately.** Cables: **CPM12 AA4** ...with cable length 2, 5 or 10 meters.

|               |                          |   |
|---------------|--------------------------|---|
| <b>LP UVA</b> | <input type="checkbox"/> | <b>03</b> = $\mu\text{V}/(\mu\text{W}/\text{cm}^2)$ output<br><b>03BL</b> = $\mu\text{V}/(\mu\text{W}/\text{cm}^2)$ output, base with levelling device<br><b>03BLAC</b> = base with levelling device output 4...20 mA<br><b>03BLAV</b> = base with levelling device output 0...10 V |
| <b>CABLE:</b> | <input type="checkbox"/> | <b>2</b> = length 2m<br><b>5</b> = length 5m<br><b>10</b> = length 10m  |

WIRING DIAGRAM  
4-pole wire CPM12 AA4...

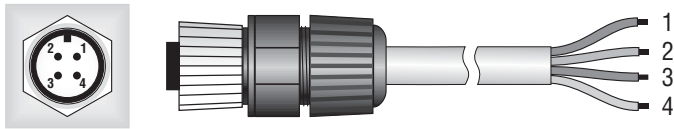

Fixed 4-pole plug M12 Flying 4-pole M12 connector

LP UVA 03, LP UVA 03BL

| Connector | Function      | Color |
|-----------|---------------|-------|
| 1         | Positive (+)  | Red   |
| 2         | Negative (-)  | Blue  |
| 3         | Not connected | White |
| 4         | Shield        | Black |

LP UVA 03BLAV

| Connector | Function             | Color |
|-----------|----------------------|-------|
| 1         | (+) V out            | Red   |
| 2         | (-) Vout and (-) Vdc | Blue  |
| 3         | (+) Vdc              | White |
| 4         | Shield               | Black |

LP UVA 03BLAC

| Connector | Function      | Color |
|-----------|---------------|-------|
| 1         | Positive (+)  | Red   |
| 2         | Negative (-)  | Blue  |
| 3         | Not connected | White |
| 4         | Shield        | Black |

LP UVB 03BLAV

The LP UVB 03BLAV probe measures global irradiance ( $W/m^2$ ) on a surface area ( $m^2$ ) in the UVB (280 nm...315 nm) spectral region. In particular, the spectral sensitivity is focused at 305 nm, with a bandwidth (FWHM) of 5nm. The global irradiance is the result of the sum of direct solar irradiance and of diffused irradiance incident on a planar surface. In the UVB spectral region, unlike in the visible portion where the direct component prevails over the direct component, the light is strongly diffused by the atmosphere and thus the two components are equivalent, therefore is very important that the instrument is capable of measuring accurately both the components. The probe is designed for **outdoor readings**. Cosine correction filter and Quartz dome.

Typical output 0...5Vdc.

TECHNICAL SPECIFICATIONS

Typical sensitivity:  $\approx 6V/(W/m^2)$   
 Typical spectral range: 301nm...306nm (1/2)  
 295...308.5nm (1/10)  
 290...311.5nm (1/100)  
 Peak at 304nm  
 Calibration uncertainty: <6%  
 $f_2$  (cosine response): <6%  
 $f_3$  (linearity): <1%  
 Working temperature: -20...+60°C  
 Output: 0...1W/m<sup>2</sup>  
 Power supply: 15...30Vdc

Typical spectral response curve LP UVB 03BLAV

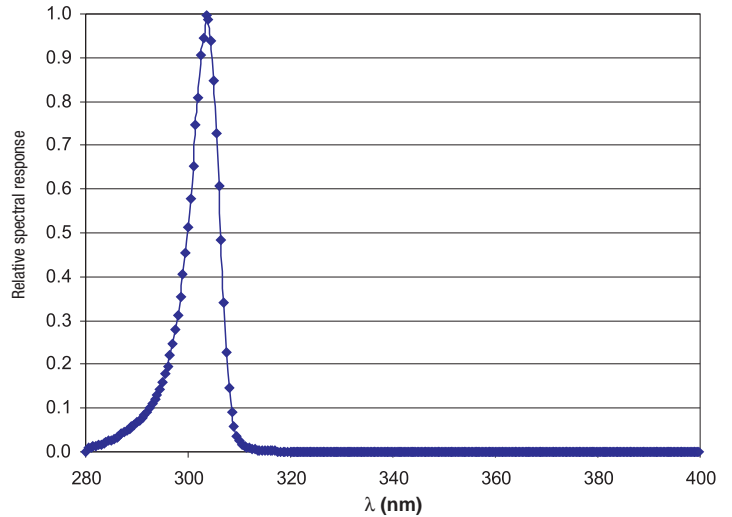

ORDERING CODE

**LP UVB 03BLAV:** Radiometric probe for the measurement of the UVB irradiance, complete with Quartz dome, 3 silica gel cartridges, 8-pole M12 connector, calibration report. **Cable with female connector has to be ordered separately.** Cables: CPM12 AA8 ..., with cable lengths 2, 5 or 10 meters.

LP UVB  **03BLAV** = 0...5 V, complete with levelling device

CABLE:  
 CPM12 AA8  **2** = length 2m  
**5** = length 5m  
**10** = length 10m



LP RAD 03 BLAC

LP RAD 03

LP RAD 03 BL

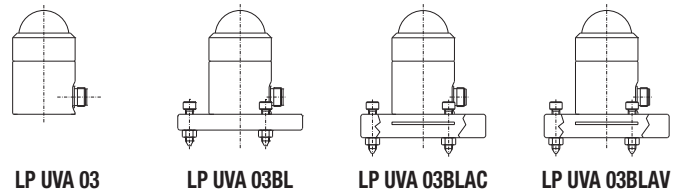

LP UVA 03

LP UVA 03BL

LP UVA 03BLAC

LP UVA 03BLAV



WIRING DIAGRAM  
8-pole wire CPM12 AA8...

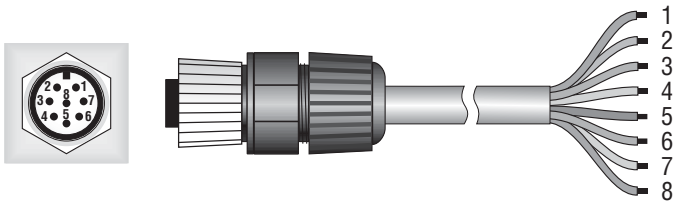

Fixed 8-pole plug M12 Flying 8-pole M12 socket

LP UVB 03BLAV

| Connector | Function            | Color |
|-----------|---------------------|-------|
| 1         | Signal GND          | Red   |
| 2         | V out UV (+)        | Blue  |
| 3         | Not connected       |       |
| 4         | Shield              | Braid |
| 5         | Power GND (-)       | Brown |
| 6         | V out Temp. (+)     | White |
| 7         | Housing             | Black |
| 8         | Power (+) 7...30Vdc | Green |

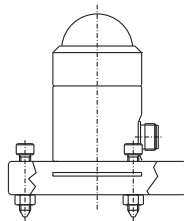

LP UVB 03BLAV

ACCESSORIES

- CPM12 AA4.2:** 4-pole cable. Length 2m. 4-pole M12 connector on one end, open wires on the other side.
- CPM12 AA4.5:** 4-pole cable. Length 5m. 4-pole M12 connector on one end, open wires on the other side.
- CPM12 AA4.10:** 4-pole cable. Length 10m. 4-pole M12 connector on one end, open wires on the other side
- CPM12 AA8.2:** 8-pole cable. Length 2m. 8-pole M12 connector on one end, open wires on the other side.
- CPM12 AA8.5:** 8-pole cable. Length 5m. 8-pole M12 connector on one end, open wires on the other side.
- CPM12 AA8.10:** 8-pole cable. Length 10m. 8-pole M12 connector on one end, open wires on the other side

- HD978TR3:** Configurable signal converter amplifier with 4...20mA (20...4mA) output. Input range -10 ...+60mVdc. **Standard configuration 0...20mVdc.** Minimum measuring range 2mVdc. 2- DIN modules for 35mm rail. **Configurable with HD778 TCAL**
- HD978TR5:** Configurable signal converter amplifier with 4...20mA (20...4mA) output. Input range -10 ...+60mVdc. **Standard configuration 0...20mVdc.** Minimum measuring range 2mVdc. **Configurable with HD778 TCAL. Container for Wall Mount installation.**
- HD978TR4:** Configurable signal converter amplifier with 0...10Vdc (10...0Vdc) output. Input range -10 ...+60mVdc. **Standard configuration 0...20mVdc.** Minimum measuring range 2mVdc. 2- DIN modules for 35mm rail. **Configurable with HD778 TCAL**
- HD978TR6:** Configurable signal converter amplifier with 0...10Vdc (10...0Vdc) output. Input range -10 ...+60mVdc. Standard configuration 0...20mVdc. Minimum measuring range 2mVdc. **Configurable with HD778 TCAL. Container for Wall Mount installation.**
- HD 778 TCAL:** Voltage generator in the range -60mVdc...+60mVdc, controlled by PC through the RS232C serial port, DELTALOG-7 software for setting K, J, T, N thermocouple transmitters and HD978TR3, HD978TR4, HD978TR5, HD978TR6 converters.

LP PHOT 03S

Transmitter with RS485 MODBUS-RTU output for LP PHOT 03 probe

The LP PHOT 03S transmitter converts the mV analog signal generated by the LP PHOT 03 illuminance probe in a digital signal suitable to be transmitted over a RS485 serial line with MODBUS- RTU protocol. The connections are made via the screw terminals accessible by unscrewing the top cover of the transmitter. The casing is designed for wall mounting.

Technical characteristics

|                                       |  |
|---------------------------------------|--|
| Measuring range with LP PHOT 03 probe | Low range: 0...10,000 lux (default)<br>High range: 0...200,000 lux |
| Resolution                            | 1 lux (low range) / 10 lux (high range)                            |
| Output                                | RS485 (1 Unit Load) with MODBUS- RTU protocol, not isolated        |
| Power supply                          | 5...30 Vdc   |
| Casing dimensions                     | 80 x 84 x 44 mm  |
| Protection degree                     | IP 66  |
| Operating temperature/humidity        | -30...+70 °C / 0...90% R.H. not condensing                         |
| Storage temperature                   | -40...+80 °C   |

Setting the RS485 communication parameters of the transmitter

Before connecting the transmitter to the RS485 network, an address must be assigned and the communication parameters be set, if different from the factory preset.

The parameters setting is performed by connecting the transmitter to the PC by using the optional RS48 cable, with built- in RS485/USB converter. To use the cable, it is necessary to install the related USB drivers in the PC. Alternatively, a generic RS485/RS232 or RS485/USB converter can be used instead of the RS48 cable.

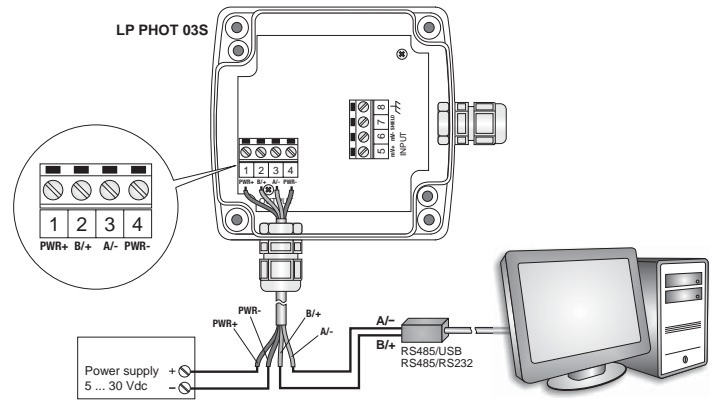

USB drivers installation notes:

**With Windows 7 and 8 operating systems, before installing the drivers it is necessary to restart the PC disabling the drivers signature request.** When Windows restarts, press F8 to display the "Advanced Boot Options" menu, then select the "Disable Driver Signature Enforcement" option.

**With 64-bit operating systems, even after installation it is necessary to disable the drivers signature request every time the PC is restarted.**

Procedure for setting the parameters

- Start with the transmitter not powered.
- Start a standard serial communication program, such as Hyperterminal. Set the COM port number to which the transmitter will be connected, set the Baud Rate to 57600 and the communication parameters as follows:  
Data Bits: 8 Parity: None Stop Bits: 2
- Switch the transmitter on and wait to receive the @ character, then send (within 10 s from power on) the @ command and press Enter.  
Note: if the transmitter does not receive the @ command within 10 seconds from power on, the RS485 MODBUS mode is automatically activated. In such a case, it is necessary to switch off and on again the transmitter.
- Send the command **CAL USER ON**.  
Note: the command CAL USER ON is disabled after 5 minutes of inactivity.
- Send the serial commands in the following table to set the RS485 MODBUS parameters:

| Command           | Response | Description   |
|-------------------|----------|---|
| CMA <sub>nn</sub> | &l       | Set RS485 address to nnn<br>Ranging from 1 to 247<br>Preset on 1  |
| CMB <sub>n</sub>  | &l       | Set RS485 Baud Rate<br>n=0 ⇒ 9600<br>n=1 ⇒ 19200<br>Preset on 1 ⇒ 19200   |
| CMP <sub>n</sub>  | &l       | Set RS485 transmission mode<br>n=0 ⇒ 8-N-1 (8 data bits, no parity, 1 stop bit)<br>n=1 ⇒ 8-N-2 (8 data bits, no parity, 2 stop bits)<br>n=2 ⇒ 8-E-1 (8 data bits, even parity, 1 stop bit)<br>n=3 ⇒ 8-E-2 (8 data bits, even parity, 2 stop bits)<br>n=4 ⇒ 8-O-1 (8 data bits, odd parity, 1 stop bit)<br>n=5 ⇒ 8-O-2 (8 data bits, odd parity, 2 stop bits)<br>Preset on 2 ⇒ 8-E-1 |
| CMW <sub>n</sub>  | &l       | Set receiving mode after RS485 transmission<br>n=0 ⇒ Violate protocol and go in Rx mode right after Tx<br>n=1 ⇒ Respect protocol and wait 3.5 characters after Tx<br>Preset on 1 ⇒ Respect the protocol   |

6. You can check the parameters setting by sending the following serial commands:

| Command | Response                 | Description  |
|---------|--------------------------|--|
| RMA     | Address                  | Read RS485 address   |
| RMB     | Baud Rate<br>(0,1)       | Read RS485 Baud Rate<br>0 ⇒ 9600<br>1 ⇒ 19200  |
| RMP     | Tx Mode<br>(0,1,2,3,4,5) | Read RS485 transmission mode<br>0 ⇒ 8-N-1<br>1 ⇒ 8-N-2<br>2 ⇒ 8-E-1<br>3 ⇒ 8-E-2<br>4 ⇒ 8-O-1<br>5 ⇒ 8-O-2   |
| RMW     | Rx Mode<br>(0,1)         | Read receiving mode after RS485 transmission<br>0 ⇒ Violate protocol and go in Rx mode right after Tx<br>1 ⇒ Respect protocol and wait 3.5 characters after Tx |

### Operating mode connection

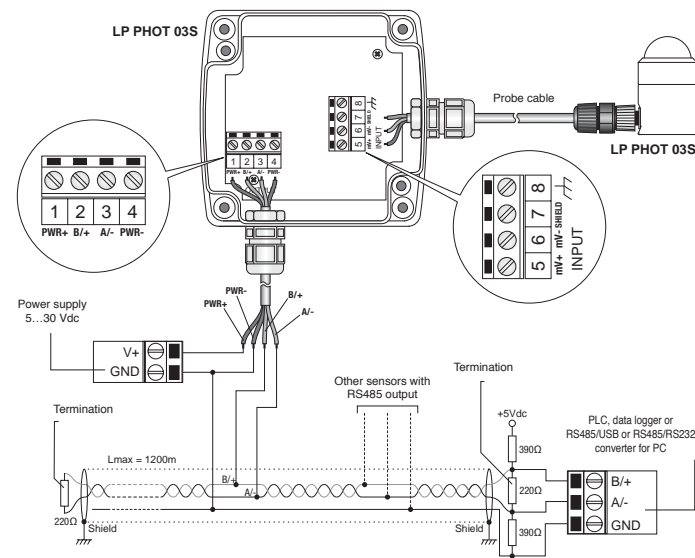

| Terminal | Symbol | Function                  |
|----------|--------|---------------------------|
| 1        | PWR+   | Power supply positive     |
| 2        | B/+    | RS485 B/+                 |
| 3        | A/-    | RS485 A/-                 |
| 4        | PWR-   | Power supply negative     |
| 5        | mV+    | mV input signal positive  |
| 6        | mV-    | mV input signal negative  |
| 7        | SHIELD | Shield of the probe cable |
| 8        |        | Earth connection          |

For best accuracy, it is advisable not to extend the length of the shielded cable supplied with the LP PHOT 03S probe. It is also recommended not to pass wiring near power cables (electric motors, induction furnaces, inverters, etc.).

In the RS485 connection, the instruments are connected through a twisted-pair shielded cable for signals and a third wire for ground. Line terminations should be placed at the two ends of the network. To polarize the line during non-transmission periods, resistors connected between signal lines and power supply are used.

The maximum number of devices that can be connected to the RS485 line (Bus) depends on the load characteristics of the devices to be connected. The RS485 standard requires that the total load does not exceed 32 unit loads. The load of an LP PHOT 03S transmitter is equal to 1 unit load. If the total load is greater than 32 unit loads, divide the network into segments and add a signal repeater between a segment and the successive one. Line termination should be applied at both ends of each segment.

### Operating mode

The transmitter enters RS485 MODBUS- RTU mode after 10 seconds from power on. In the first 10 seconds from power on the transmitter does not reply to requests from the MODBUS master unit. After 10 seconds, it is possible to send MODBUS requests to the transmitter.

### Reading of the measures with the MODBUS-RTU protocol

In MODBUS mode, you can read the values measured by the instrument through the function code 04h (Read Input Registers). The following table lists the information available with the appropriate register address:

| Address | Quantity   | Format         |
|---------|--|----------------|
| 2       | Illuminance in lux (low range) or lux/10 (high range)  | 16-bit Integer |
| 3       | Status register<br>bit 0 = 1 ⇒ illuminance measurement error<br>bit 2 = 1 ⇒ configuration data error<br>bit 3 = 1 ⇒ program memory error | 16-bit Integer |
| 4       | Average illuminance in lux (low range) or lux/10 (high range)<br>The average refers to the last 4 measures                               | 16-bit Integer |
| 5       | Input signal value in $\mu$ V (low range) or $\mu$ V/10 (high range)   | 16-bit Integer |

### Setting the probe sensitivity and the measuring range

The measuring range preset in the transmitter is 0...10,000 lux (low range), normally suitable for indoor measurements. If higher values should be measured, for example in the case of outdoor measurements, the measuring range 0...200,000 lux (high range) can be set. Different resolutions correspond to the two measuring ranges: 1 lux for the low range, 10 lux for the high range.

The setting of the probe sensitivity is required when replacing the probe connected to the transmitter with a new probe having different sensitivity.

To set the probe sensitivity and the measuring range, proceed as follows:

- Start with the transmitter not powered.
- Connect the transmitter to the PC by using the **optional RS48 cable**.
- Start a standard serial communication program, such as Hyperterminal. Set the COM port number to which the transmitter will be connected, set the Baud Rate to 57600 and the communication parameters as follows:  
Data Bits: 8  
Parity: None  
Stop Bits: 2
- Switch the transmitter on and wait to receive the & character, then send (within 10 s from power on) the @ command and press Enter.  
Note: if the transmitter does not receive the @ command within 10 seconds from power on, the RS485 MODBUS mode is automatically activated. In such a case, it is necessary to switch off and on again the transmitter.
- Send the command **CAL START**.  
Note: the command CAL START is disabled after 5 minutes of inactivity.
- Send the following serial commands:

| Command | Response | Description  |
|---------|----------|--|
| CLSnnn  | &l       | Set the probe sensitivity to the value nnn in $\mu$ V/klux<br>nnn indicates a 3 or 4-digit integer number between 500 and 2500 |
| O2E     | &l       | Set low range (0...10,000 lux, 1 lux resolution)   |
| O2D     | &l       | Set high range (0...200,000 lux, 10 lux resolution)  |

- You can check the probe sensitivity and the measuring range setting by sending the following serial commands:

| Command | Response | Description   |
|---------|----------|---|
| RLS     | &nnnl    | Read the set sensitivity in $\mu$ V/klux  |
| RO      | hhll     | Read the configuration byte<br>bit 2 = 0 ⇒ high range (0...200,000 lux, 10 lux resolution)<br>bit 2 = 1 ⇒ low range (0...10,000 lux, 1 lux resolution)<br>The bit 2 is the third bit from the right of the configuration byte |

Note: it is not required to send the CAL START command to read the settings with the RLS and RO commands.

When the settings are completed, switch the transmitter off and then back on to activate the RS485 MODBUS- RTU operating mode.

### Dimensions

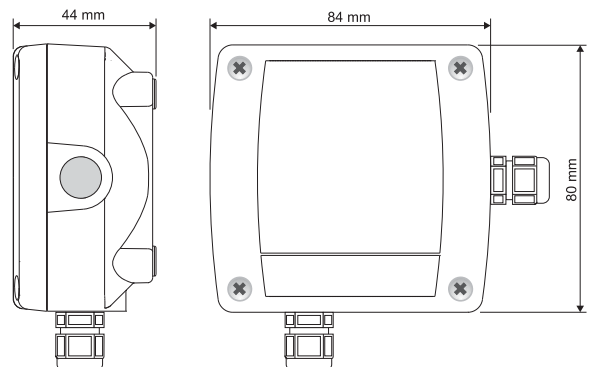

### Ordering codes

**LP PHOT 03S:** Transmitter with RS485 MODBUS- RTU output for the LP PHOT 03 illuminance probe. Measuring range: 0...10,000 lux with 1 lux resolution or 0...200,000 lux with 10 lux resolution. Connections via screw terminals. Wall mount casing. Power supply 5...30 Vdc. Supplied with LP PHOT 03 illuminance probe.

**RS48:** PC connection cable for the configuration of the MODBUS parameters. With built-in RS485/USB converter. Open wires on the instrument side and USB A- type connector on the PC side.