



LP PHOT 01S

LP PHOT 01, LP RAD 01, LP PAR 01, LP UVA 01, LP UVB 01, LP UVC 01 PHOTOMETRIC/RADIOMETRIC PROBES WITH mV SIGNAL OUTPUT. LP PHOT 01S WITH RS485 MODBUS-RTU OUTPUT

The probes of the series LP...01 allow measurement of photometric and radiometric quantities such as illuminance (lux), irradiance (W/m^2) across VIS-NIR, UVA, UVB, UVC spectral regions, the number of photons per time unit and area in the PAR region (400nm ... 700nm).

In probes LP...01 there is no need for external power supply. Output signal in mV is given through a resistor shunting the photodiode ends. Photocurrent generated by the photodiode when hit by light, is converted to a potential difference, which is read by a voltmeter. Once the DDP (Potential Difference) has been read, the measured value can be calculated through the calibration factor. **All probes are individually calibrated and the calibration factor is shown both on the probe housing and on the user manual and is specific to that probe.** LP...01 probes are equipped with cosine corrected diffuser. In probes for UV measurements the diffuser is made of sanded quartz, for the other probes, the diffuser is commonly made of acrylic material or teflon® (LP PHOT 01). LP...01 probes are suitable for indoor applications which requires the constant monitoring of the quantities specified. The output signal can be amplified or converted into a 4...20mA or 0...10Vdc signal by using a converter of the series HD978TR3 (4...20mA) and HD978TR4 (0...10Vdc) for DIN rail attachment, or the wall mounting types HD978TR5 (4...20mA) and HD978TR6 (0...10Vdc).

Installing the probes

Once the installation place has been decided, the connections between the probe and the voltmeter should be provided; the voltmeter should have proper scales of measurement. The connection diagram of the probe output cables is shown in the user manual. For measurements in weather and agriculture stations or in nursery-gardening systems, the probe reference plane should be mounted parallel to the ground; in this case, the probe shall be mounted on a LP BL (optional) support provided with bubble level.

Probe description

LP PHOT 01:

The LP PHOT 01 probe measures illuminance (lux) defined as the ratio between the luminous flux (lumen) passing through a surface and the surface area (m^2).

The spectral response curve of a photometric probe is equal to the one of the human eye, known as standard photopic curve $V(\lambda)$. The difference in spectral response between LP PHOT 01 and the standard photopic curve $V(\lambda)$ is calculated by means of the error f_1' . The calibration of the probe is performed by comparing it to a luxmeter calibrated by a Primary Metrological Institute. All calibration procedures follow the CIE publication No 69 (1987) "Method of

Characterizing Illuminance Meters and Luminance Meters". The calibration is carried out by illuminating the probe with a standard illuminant A.

TECHNICAL SPECIFICATIONS

Typical sensitivity:	0.5 ... 1.5 mV/klux
Spectral range:	$V(\lambda)$
Calibration accuracy:	<4%
f_1' ($V(\lambda)$ match error):	<6%
f_2 (cosine response/directional error):	<3%
f_3 (linearity):	<1%
f_5 (fatigue):	<0.5%
Operating temperature:	0...50°C
Output impedance:	0.5 ... 1 kΩ



Typical spectral response LP PHOT 01

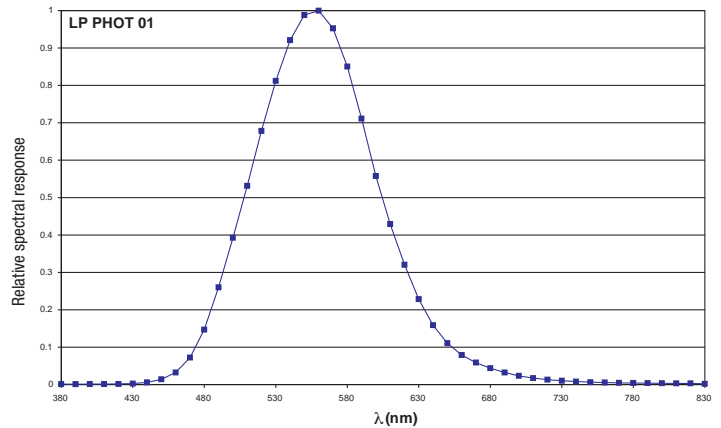

LP RAD 01:

The LP RAD 01 probe measures irradiance (W/m^2) defined as the ratio between the radiant flux (W) passing through a surface and the surface area (m^2) in the VIS-NIR (400nm...1050nm) spectral range. These particular features apply to an instrument suitable for measurements in visible and near infrared fields. **Probe calibration is carried out by using 577 and 579 nm lines of a Xe-Hg lamp, filtered through a special interferential filter.**

TECHNICAL SPECIFICATIONS

Typical sensitivity:	2.6 $\mu V/(\mu W/cm^2)$
Measuring range:	0 ... 200 mW/cm^2
Spectral range:	$\approx 400nm... \approx 1050nm$
Calibration accuracy:	<6%
f_2 (cosine response/directional error):	<6%
Operating temperature:	0 ... 50°C
Output impedance:	1 kΩ



Typical spectral response LP RAD 01

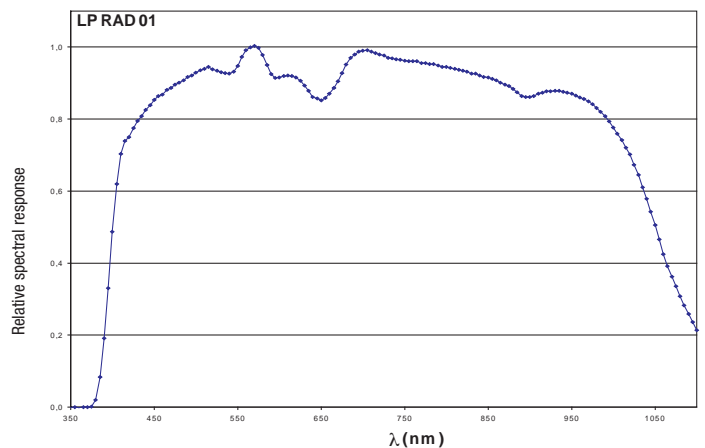

LP UVA 01:

The LP UVA 01 probe measures irradiance (W/m^2) defined as the ratio between the radiant flux (W) passing through a surface and the surface area (m^2) in the UVA (315 nm ... 400 nm) spectral range. Thanks to a new type of photodiode, LP UVA 01 is blind to visible and infrared light.

Probe calibration is carried out by using a 365 nm line of a Xe-Hg lamp, filtered through a special interferential filter. Measurement is carried out by comparison with the primary standards, assigned to Delta Ohm Metrological Laboratory.

This probe can be used in all processes where ultraviolet lamp emission needs to be monitored: resins and adhesives polymerization, as well as tanning lamps.

Light

TECHNICAL SPECIFICATIONS

Typical sensitivity: 2.6 $\mu\text{V}/(\mu\text{W}/\text{cm}^2)$
 Measuring range: 0...200 mW/cm^2
 Typical spectral range: peak at ≈ 360 nm and FWHM 60 nm
 Calibration accuracy: <6%
 Working temperature: 0...50°C
 Output impedance: 1 k Ω



Typical spectral response LP UVA 01

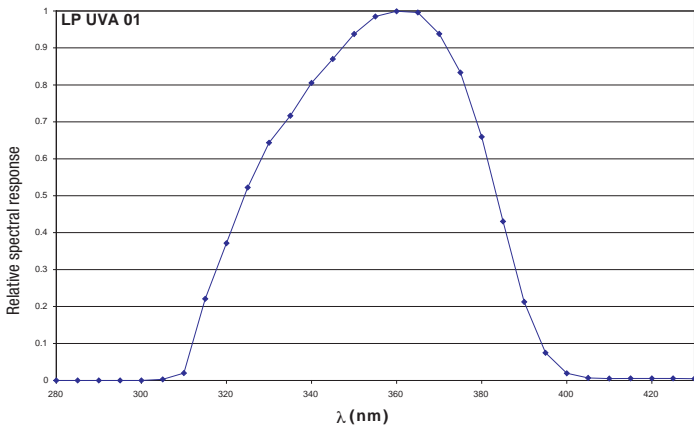

LP UVB 01:

The LP UVB 01 probe measures irradiance (W/m^2) defined as the ratio between the radiant flux (W) passing through a surface and the surface area (m^2) in the UVB (280 nm ...315 nm) spectral range. Thanks to a new type of photodiode, LP UVB 01 is blind to visible and infrared light. **Probe calibration is carried out by using a 313 nm line** of a Xe-Hg lamp, filtered through a special interferential filter. Measurement is carried out by comparison with the primary standards, assigned to Delta Ohm Metrological Laboratory.

TECHNICAL SPECIFICATIONS

Typical sensitivity: 0.19 $\mu\text{V}/(\mu\text{W}/\text{cm}^2)$
 Measuring range: 0...200 mW/cm^2
 Typical spectral range: peak at ≈ 305 nm and FWHM 31 nm
 Calibration accuracy: <8%
 Working temperature: 0...50°C
 Output impedance: 2 k Ω



Typical spectral response LP UVB 01

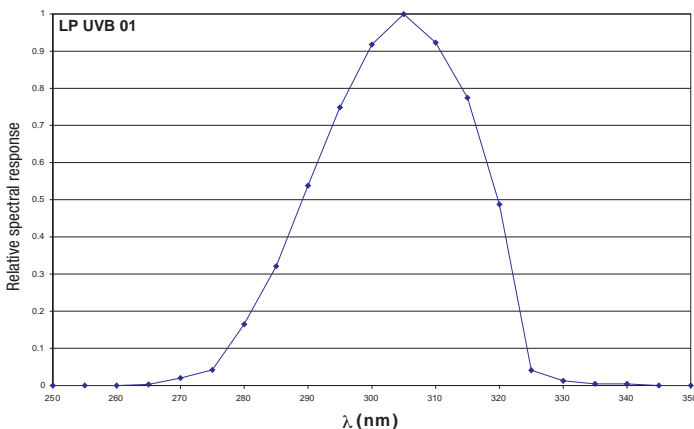

LP UVC 01:

The LP UVC 01 probe measures irradiance (W/m^2) defined as the ratio between the radiant flux (W) passing through a surface and the surface area (m^2) in the UVC (200nm ...280nm) spectral range. Thanks to a new type of photodiode, LP UVC 01 is blind to visible and infrared light. **The probe calibration is carried out by measuring irradiance coming from an Hg lamp at 254nm.**

TECHNICAL SPECIFICATIONS

Typical sensitivity: 0.19 $\mu\text{V}/(\mu\text{W}/\text{cm}^2)$
 Measuring range: 0...200 mW/cm^2
 Typical spectral range: peak at 260 and FWHM 32nm
 Calibration accuracy: <10%
 Working temperature: 0...50°C
 Output impedance: 2 k Ω



Typical spectral response LP UVC 01

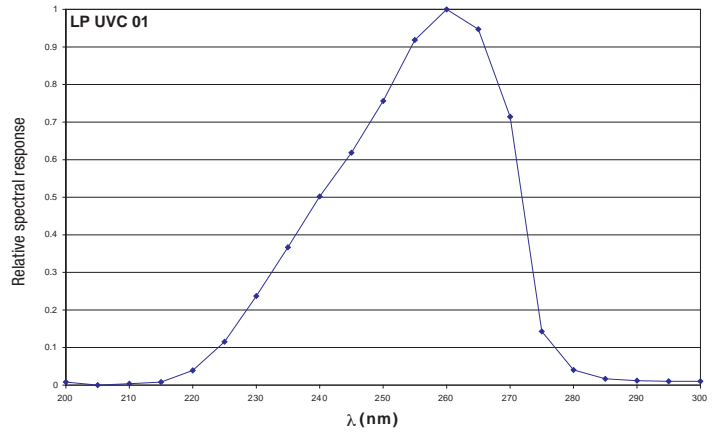

LP PAR 01:

The LP PAR 01 probe measures the ratio between the number of photons that strike a surface in one second, in the 400nm ... 700nm spectral range and the surface area (m^2). This quantity is defined as PAR: Photosynthetically Active Radiation.

The probe calibration is carried out by using an halogen lamp, with a known spectral irradiance in a specific spectral range.

Temperature slightly affects the probe spectral response.

The diffuser and the probe particular structure, allow the response to the variation of the light incidence angle on the diffuser, to be cosine corrected.

TECHNICAL SPECIFICATIONS

Typical sensitivity: 30 $\mu\text{V}/(\mu\text{mol}\cdot\text{m}^{-2}\cdot\text{s}^{-1})$
 Measuring range: 0...5000 $\mu\text{mol}\cdot(\text{m}^{-2}\cdot\text{s}^{-1})$
 Typical spectral range: 400 nm ... 660 nm
 Calibration accuracy: <6%
 f_2 (cosine response/directional error): <6%
 Operating temperature: 0...50°C
 Output impedance: 1 k Ω



Typical spectral response LP PAR 01

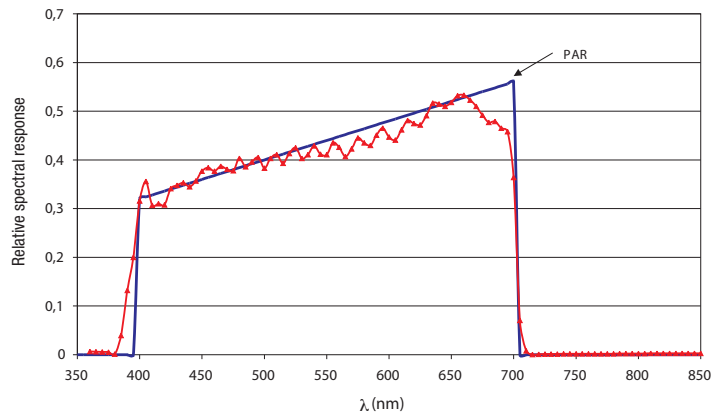

Ordering codes:

LP PHOT 01: Photometric probe for measuring ILLUMINANCE, CIE photopic filter, diffuser for correction according to the cosine law. mV per klux output, cable 5m long.

LP RAD 01: Radiometric probe for measuring IRRADIANCE, diffuser for correction according to the cosine law. mV per mW/cm^2 output, cable 5m long.

LP PAR 01: Radiometric probe for measuring PHOTONS FLUX in the range of PAR (Photosynthetically Active Radiation). Cosine correction. mV per $\mu\text{mol}/\text{m}^2\cdot\text{s}$ output, cable 5m long.

LP UVA 01: Radiometric probe for measuring IRRADIANCE in the UVA (315...400nm). $\mu\text{V}/\mu\text{Wcm}^{-2}$ output, cable 5m long.

LP UVB 01: Radiometric probe for measuring IRRADIANCE in the UVB (280...315nm). $\mu\text{V}/\mu\text{Wcm}^{-2}$ output, cable 5m long.

LP UVC 01: Radiometric probe for measuring IRRADIANCE in the UVC (200...280nm). $\mu\text{V}/\mu\text{Wcm}^{-2}$ output, cable 5m long.

LP BL: Base with levelling device. On request for assembly with the probes at the time of placing the order.

HD978TR3: Configurable signal converter amplifier with 4...20mA (20...4mA) output. Input measuring range -10...+60mV. Default setting 0...20mV. For DIN rail attachment. Minimum measuring range 2mV.

HD978TR4: Configurable signal converter amplifier with 0...10Vdc (10...0Vdc) output. Input measuring range -10...+60mV. Default setting 0...20mV. For DIN rail attachment. Minimum measuring range 2mV.

HD978TR5: Configurable signal converter amplifier with 4...20mA (20...4mA) output. Input measuring range -10...+60mV. Default setting 0...20mV. Minimum measuring range 2mV.

HD978TR6: Configurable signal converter amplifier with 0...10Vdc (10...0Vdc) output. Input measuring range -10...+60mV. Default setting 0...20mV. Minimum measuring range 2mV.

LP PHOT 01S

Transmitter with MODBUS-RTU RS485 output for the probe LP PHOT 01

The transmitter LP PHOT 01S converts the mV analog signal generated by the illumination probe LP PHOT 01 into a digital signal suitable to be transmitted over a serial line RS485 with MODBUS-RTU protocol. All connections are made via screw terminals accessible by removing the top cover of the transmitter. The container is designed for wall mounting.

Technical specifications

Measuring range of the probe LP PHOT 01	Low range: 0...10.000 lux (default) High Range: 0...200.000 lux
Resolution	1 lux (low range) / 10 lux (high range)
Output	RS485 (1 Unit Load) with MODBUS-RTU protocol, non isolated
Power supply	5...30 Vdc
Housing dimensions	80 x 84 x 44 mm
Protection degree	IP 66
Working Temperature / %RH	-30...+70 °C / 0...90% U.R. without condensation
Storage temperature	-40...+80 °C

Setting the RS485 communication parameters of the transmitter

Before connecting the transmitter to the RS485 network, assign an address and set the communication parameters, if different from those preset by the factory.

The parameter setting is done by connecting the transmitter to the PC via optional RS485, with integrated converter RS485/USB. In order to use the cable the USB drivers should be installed on your PC. Alternatively, instead of the cable RS485, it is possible to use a generic RS485/RS232 or RS485/USB converter.

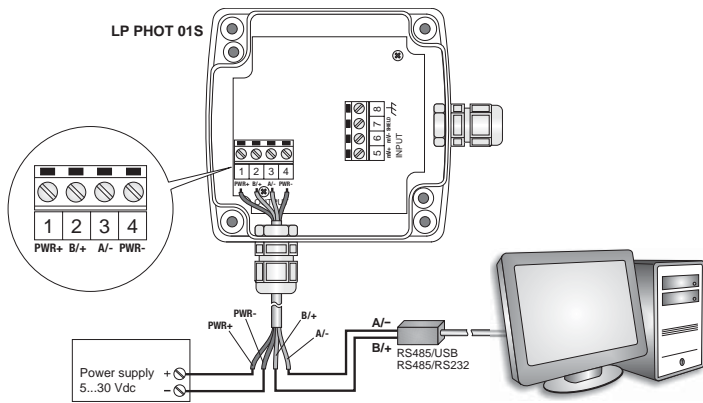

Notes on the USB driver installation:

With operating systems Windows 7 and Windows 8, before installing the driver, restart the PC by disabling the driver signing request. During the restart, press F8 to display the menu "Advanced Boot Options", then select the "Disable Driver Signature Enforcement".

With a 64-bit operating system, even after installation, the request of the driver signing must be disabled every time the PC is restarted.

Procedure for setting the parameters.

- The transmitter should be powered off.
- Start a program of serial communication standards, such as Hyperterminal. set the number of the COM port to which the transmitter should be connected, set the Baud Rate to 57600 and the communication parameters as follows:
Data bits: 8 Parity: None Stop bits: 2
- Power the transmitter on and wait for the reception of the character &, then send (within 10s from the instant the transmitter is powered on), the @ command and press the enter key.

Note: If the transmitter does not receive the @ command within 10 seconds since when powered, it automatically switches the RS485 MODBUS on. In this case, it is necessary to remove and restore power to the transmitter.

4. Send the command CAL USER ON.

Note: The command CAL USER ON turns off after 5 minutes of inactivity.

- Send the serial commands reported in the following table to set the parameters of RS485 MODBUS:

Command	Response	Description
CMAnnn	&l	Set address RS485 a nnn Between 1 and 247 Preset to 1
CMBn	&l	Set Baud Rate RS485 n=0 ⇒ 9600 n=1 ⇒ 19200 Preset to 1 ⇒ 19200

Command	Response	Description
CMPn	&l	Sets transmission mode RS485 n=0 ⇒ 8-N-1 (8 data bit, no parity, 1 stop bit) n=1 ⇒ 8-N-2 (8 data bit, no parity, 2 stop bit) n=2 ⇒ 8-E-1 (8 data bit, no parity, 1 stop bit) n=3 ⇒ 8-E-2 (8 data bit, no parity, 2 stop bit) n=4 ⇒ 8-O-1 (8 data bit, no parity, 1 stop bit) n=5 ⇒ 8-O-2 (8 data bit, no parity, 2 stop bit) Preset to 2 ⇒ 8-E-1
CMWn	&l	Sets receiving mode after RS485 transmission n=0 ⇒ Violates the protocol and goes in Rx mode right after Tx n=1 ⇒ Respects the protocol and waits 3.5 characters after Tx Preset on 1 ⇒ Respects the protocol

6. It is possible to check the parameter settings by sending the following commands:

Command	Response	Description
RMA	Address	Reads the RS485 address
RMB	Baud Rate	Reads RS485 Baud Rate 0 ⇒ 9600 1 ⇒ 19200
RMP	Tx Mode (0,1,2,3,4,5)	Reads RS485 transmission mode 0 ⇒ 8-N-1 1 ⇒ 8-N-2 2 ⇒ 8-E-1 3 ⇒ 8-E-2 4 ⇒ 8-O-1 5 ⇒ 8-O-2
RMW	Rx Mode (0,1)	Reads receiving mode after RS485 transmission 0 ⇒ Violates the protocol and goes in Rx mode right after Tx 1 ⇒ Respects the protocol and waits 3.5 characters after Tx

Connection diagram for the operating mode

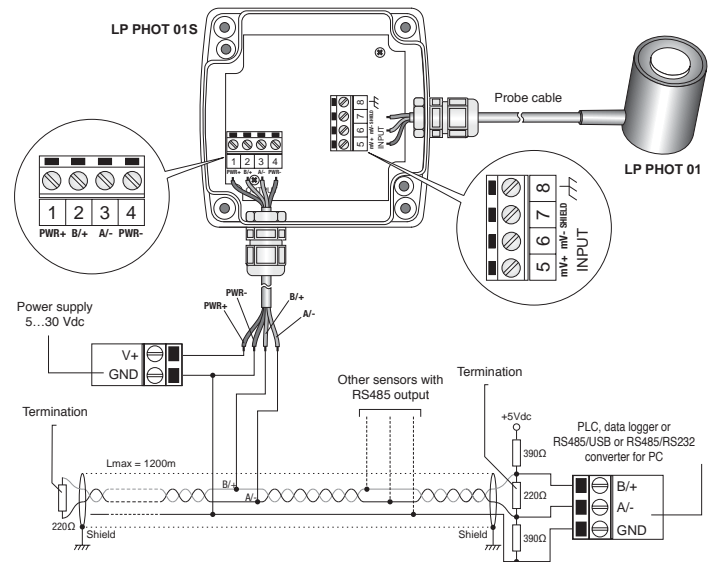

Terminal	Symbol	Function
1	PWR+	Positive Power Supply
2	B/+	RS485 B/+
3	A/-	RS485 A/-
4	PWR-	Negative Power Supply
5	mV+	Positive input signal in mV
6	mV-	Negative input signal in mV
7	SHIELD	Probe cable shield
8		Grounding

In order to get the maximum accuracy, it is recommended not to extend the shielded cable that came with the LP PHOT 01. It is also recommended not to pass the wiring in the vicinity of power cables (motors, induction ovens, inverters, etc...).

In RS485 connection, the instruments are connected via a shielded twisted pair cable for signals and a third wire for grounding. At the two ends of the network must present the line terminations. To polarize the line during periods of non-transmission, use the resistors connected among the signal lines and the power supply.

The maximum number of devices connected to the line (Bus) RS485 depends on the load characteristics of the devices to be connected. The RS485 standard requires that the total load does not exceed 32 unit loads (Unit Loads). The load of a transmitter LP PHOT 01S is equal to 1 unit load.

If the total load is greater than 32 unit loads, divide the network into segments and then put in a segment and the next a signal repeater. The beginning and end of each segment must be applied for line termination.

Operating mode

The transmitter enters the RS485 MODBUS-RTU mode after 10 seconds after turning on. During the first 10 seconds after turning on, the unit does not respond to any requests from the "master" MODBUS unit. After 10 seconds, it is possible to send requests to the transmitter MODBUS

Reading the measurements by using the MODBUS-RTU protocol

It is possible to read the measured values by the transmitter by using code function 04h (Read Input Registers). The following table lists the information available with the appropriate register address:

Address	Quantity	Format
2	Illuminance in lux (low range) or lux/10 (high range)	16 Integer
3	Status register bit 0 = 1 ⇒ measure illuminance in error bit 2 = 1 ⇒ error in the configuration data bit 3 = 1 ⇒ error in the program memory	16 Integer
4	Average illuminance in lux (low range) or lux/10 (high range) The average of the last 4 measurements	16 Integer
5	Value of the input signal in μV (low range) or $\mu\text{V}/10$ (high range)	16 Integer

Setting the sensitivity of the probe and the measurement range

The measuring range preset in the transmitter is 0...10,000 lux (low range), normally suitable for indoor measurements. If it has to be higher, for example in the case of outdoor measurements, it can be set to 0...200,000 lux (high range). The two ranges meet different resolutions: 1 lux for the low range, 10 lux for the high range.

The setting of the value of the probe sensitivity is required in case of replacement of the probe connected to the transmitter with a new probe with different sensitivity.

In order to set the sensitivity of the probe and the measurement range, proceed as follows:

1. Start when the transmitter is not powered.
2. Connect the transmitter to your PC via **optional RS48 cable**.
3. Start a standard serial communication program, such as Hyperterminal. Set the number of the COM port to which the transmitter has to be connected, set the Baud Rate to 57600 and communication parameters as follows:
Data Bits: 8
Parity: None
Stop bit: 2
4. Power the transmitter on and wait for the reception of the character **&**, then send (within 10 s from the instant the transmitter is powered on) the **@** command and press the **enter** key.
Note: If the transmitter does not receive the **@** command within 10 seconds since when powered, it automatically switches to the RS485 MODBUS. In this case it is necessary to remove and restore the power to the transmitter.
5. Send the command **CAL START**.
Note: The command CAL START turns off after 5 minutes of inactivity.
6. Send the following serial commands:

Command	Response	Description
CLSnnn	&l	Sets the sensitivity of the probe to the value nnn in $\mu\text{V}/\text{klux}$
02E	&l	Sets a low range (0...10.000 lux, resolution 1 lux)
02D	&l	Sets a high range (0...200.000 lux, resolution 10 lux)

7. It is possible to check the setting of the sensitivity of the probe and of the measurement range by sending the following commands:

Command	Response	Description
RLS	&nnnl	Reads the set sensitivity in $\mu\text{V}/\text{klux}$
RO	hhhl	Reads the configuration bite: bit 2 = 0 ⇒ high range (0...200.000 lux, resolution 10 lux) bit 2 = 1 ⇒ low range (0...10.000 lux, resolution 1 lux) <i>the bit 2 is the third bit from the right of the configuration byte</i>

Note: the reading of the settings with the controls and RLS and RO does not require sending the command CAL START.

At the end of the settings, turn off and on the transmitter to activate the operating mode RS485 MODBUS-RTU.

Dimensions

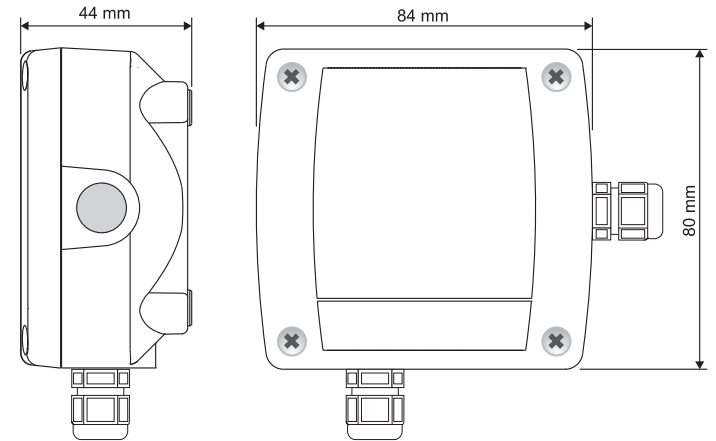

Ordering codes

LP PHOT 01S: Transmitter with RS485 MODBUS-RTU for the illumination probe LP PHOT 01. Measuring range: 0...10,000 lux with resolution 1 lux or 0...200,000 lux with resolution 10 lux. Connections with screw terminals. Housing for wall mounting. Power supply 5...30 Vdc. Equipped with illumination probe LP PHOT 01.

RS48: Connecting cable to PC for the configuration of the MODBUS parameters. Equipped with integrated converter RS485/USB. Free leads from the instrument, USB type A connector on the PC side.